

3 3D Oljeutskiller
Allerede montert

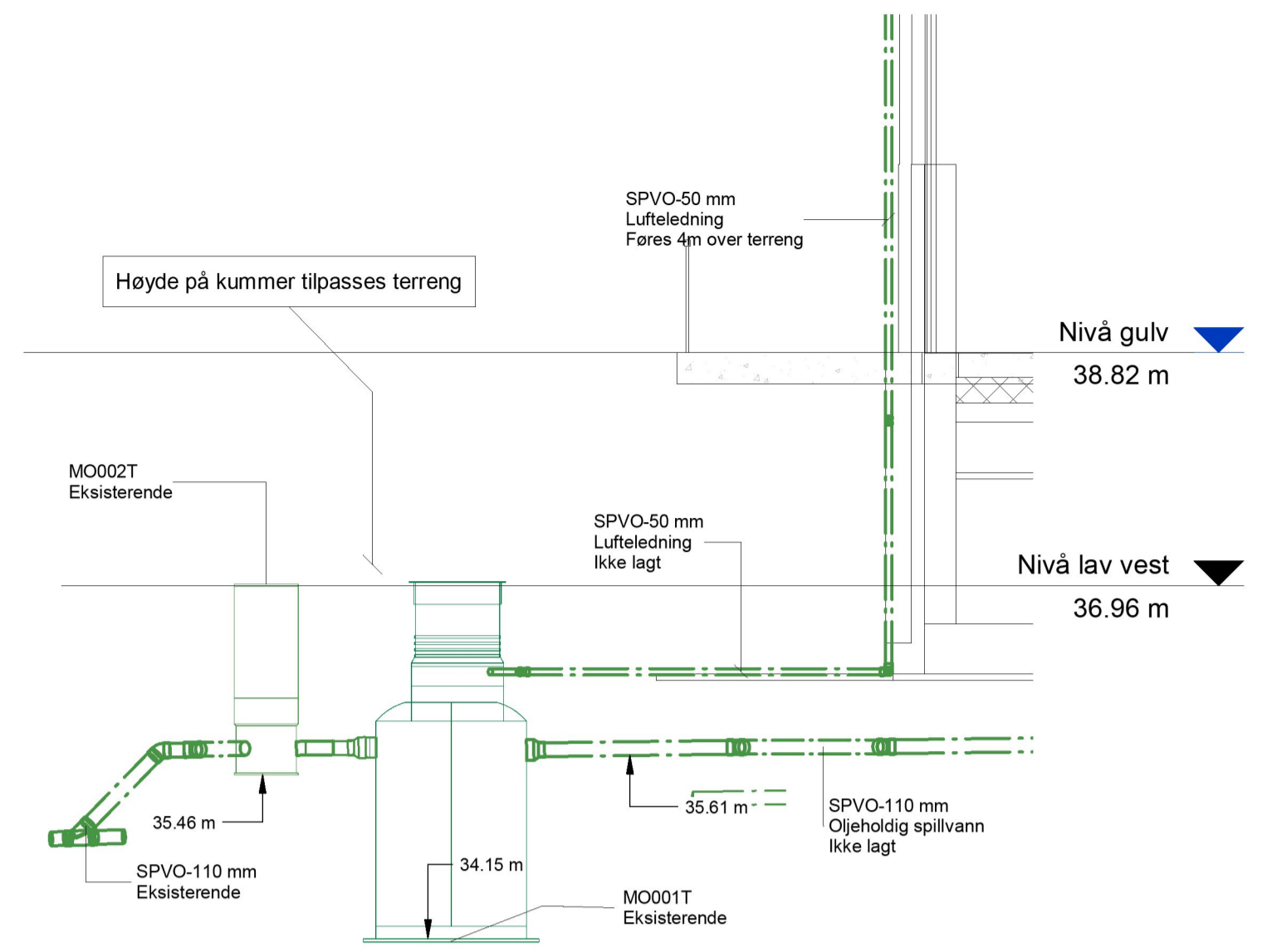

2 Snitt oljeutskiller
1 : 50

Tegn. nr V-10-UH-30-00-2021		Rev. B																				
TEGNFORKLARING																						
Drens	---																					
Spillvann	---																					
Overvann	---																					
Radonsikring	---																					
Vannledning	---																					
Overvannsrenne	---																					
Taknedløp 6-13 avsluttes 2,5m over bakkenivå. Taknedløp 1-5-13 avsluttes ved taksluk																						
Rev	Revideringen gjelder	Tegn. Kontr. Dato.																				
<table border="1"> <tr> <td>Tilbudstegning Totalentreprise</td> <td>ED</td> <td>SAL</td> <td>09.02.23</td> </tr> <tr> <td>Tilbudstegning Byggetrim HEB</td> <td>ED</td> <td>SAL</td> <td>04.04.22</td> </tr> <tr> <td>B Oppsettikk overvann for VP</td> <td>ED</td> <td>SAL</td> <td>11.02.22</td> </tr> <tr> <td>A Arbeidstegning grunnarbeider</td> <td>ED</td> <td>SAL</td> <td>22.12.21</td> </tr> <tr> <td>Tilbudstegning grunnarbeider</td> <td>ED</td> <td>SAL</td> <td>07.10.21</td> </tr> </table>			Tilbudstegning Totalentreprise	ED	SAL	09.02.23	Tilbudstegning Byggetrim HEB	ED	SAL	04.04.22	B Oppsettikk overvann for VP	ED	SAL	11.02.22	A Arbeidstegning grunnarbeider	ED	SAL	22.12.21	Tilbudstegning grunnarbeider	ED	SAL	07.10.21
Tilbudstegning Totalentreprise	ED	SAL	09.02.23																			
Tilbudstegning Byggetrim HEB	ED	SAL	04.04.22																			
B Oppsettikk overvann for VP	ED	SAL	11.02.22																			
A Arbeidstegning grunnarbeider	ED	SAL	22.12.21																			
Tilbudstegning grunnarbeider	ED	SAL	07.10.21																			
KARMØY KOMMUNE P56800 - NY GJENVINNGSSTASJON BORGAREDALEN Utendørsplan VVS																						
TEGN ED DATO KONTR SAL DATO 16.11.22		Målestokk: As indicated Status: TILBUDSTEGNING Prosj nr 2321 Tegn. nr V-10-UH-30-00-2021 Rev. B																				



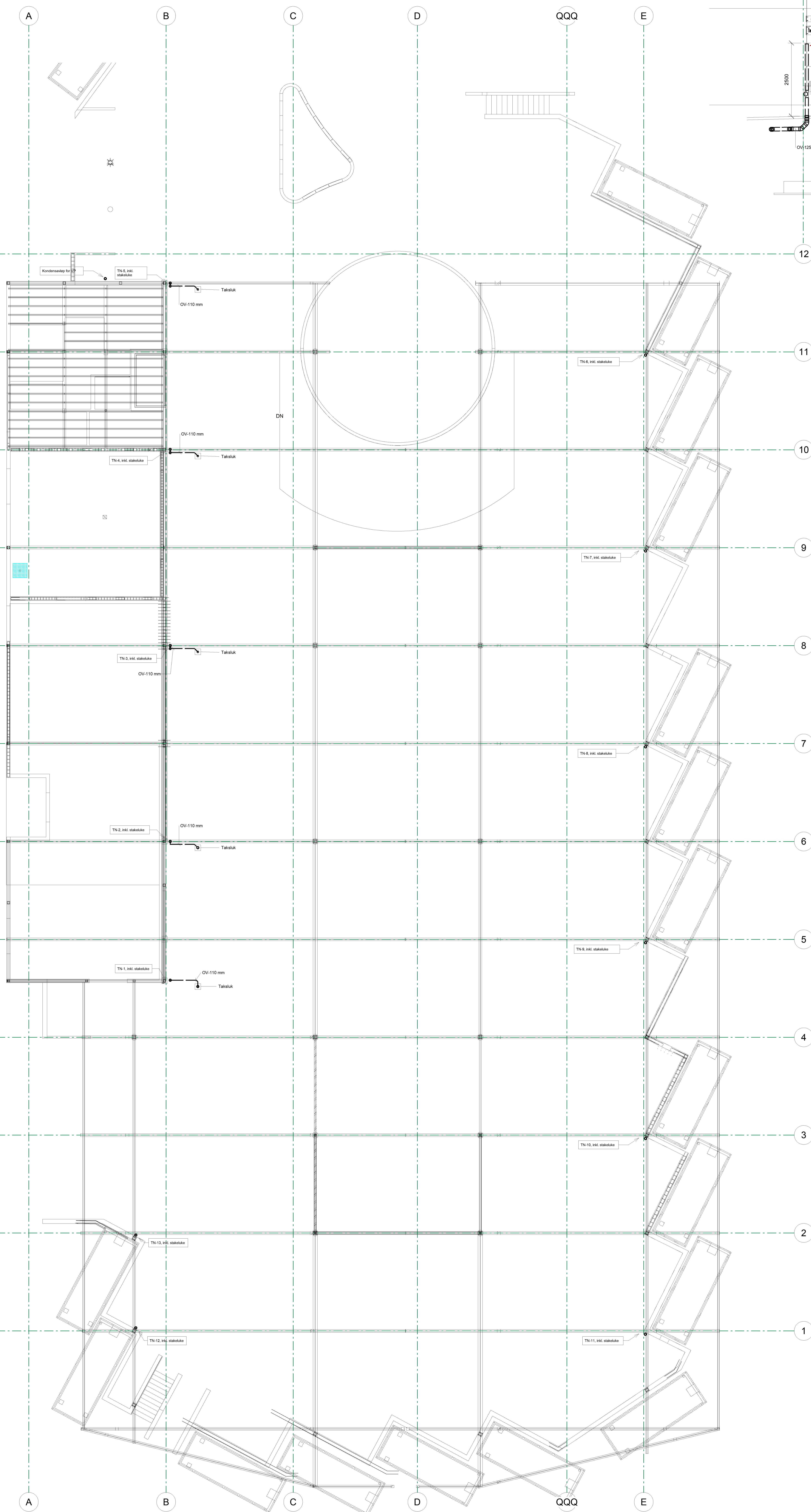

1 Plan under yttertak - Utskrift
1 : 100

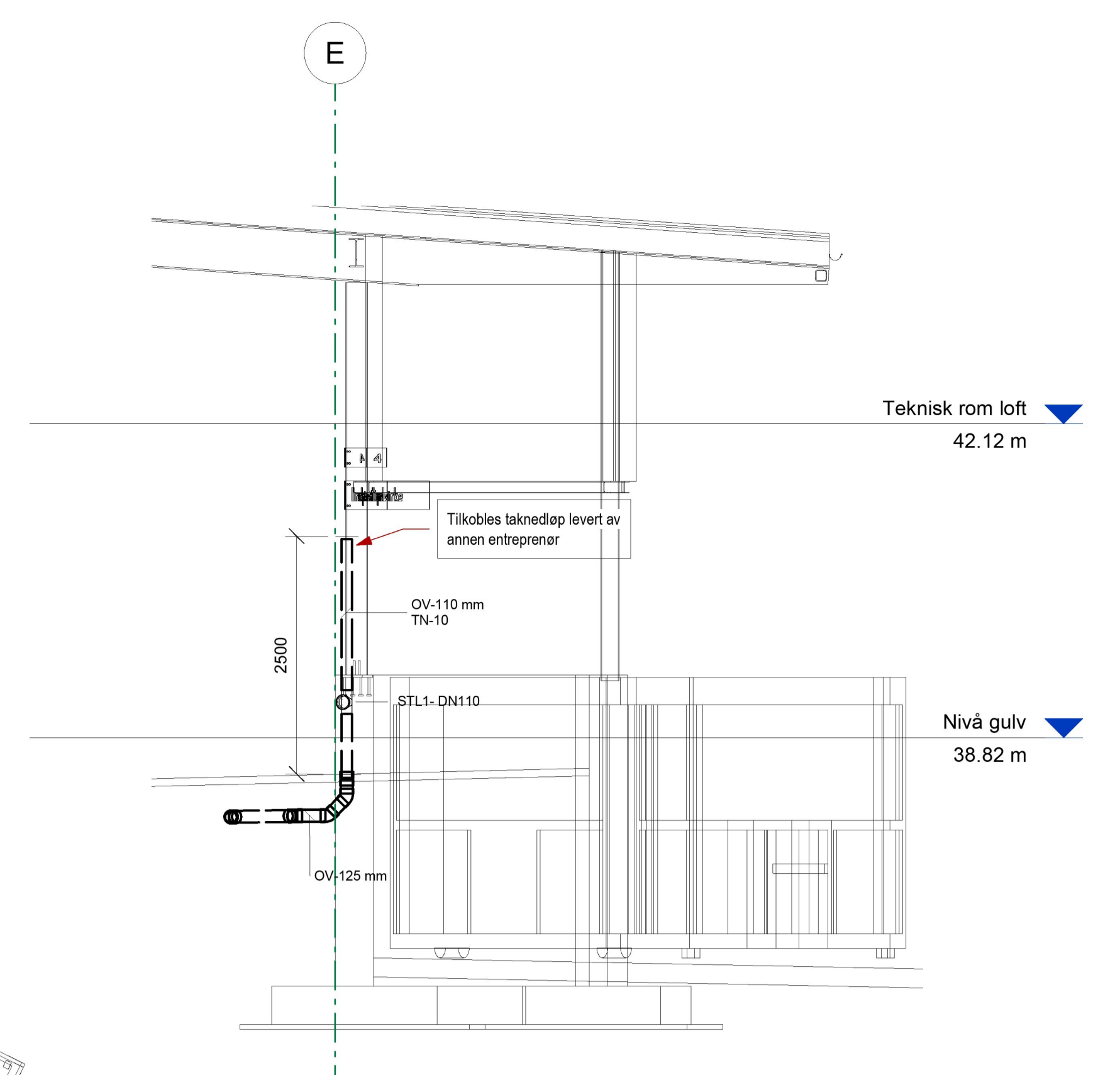

2 Prinsipp taknedløp1
1 : 50

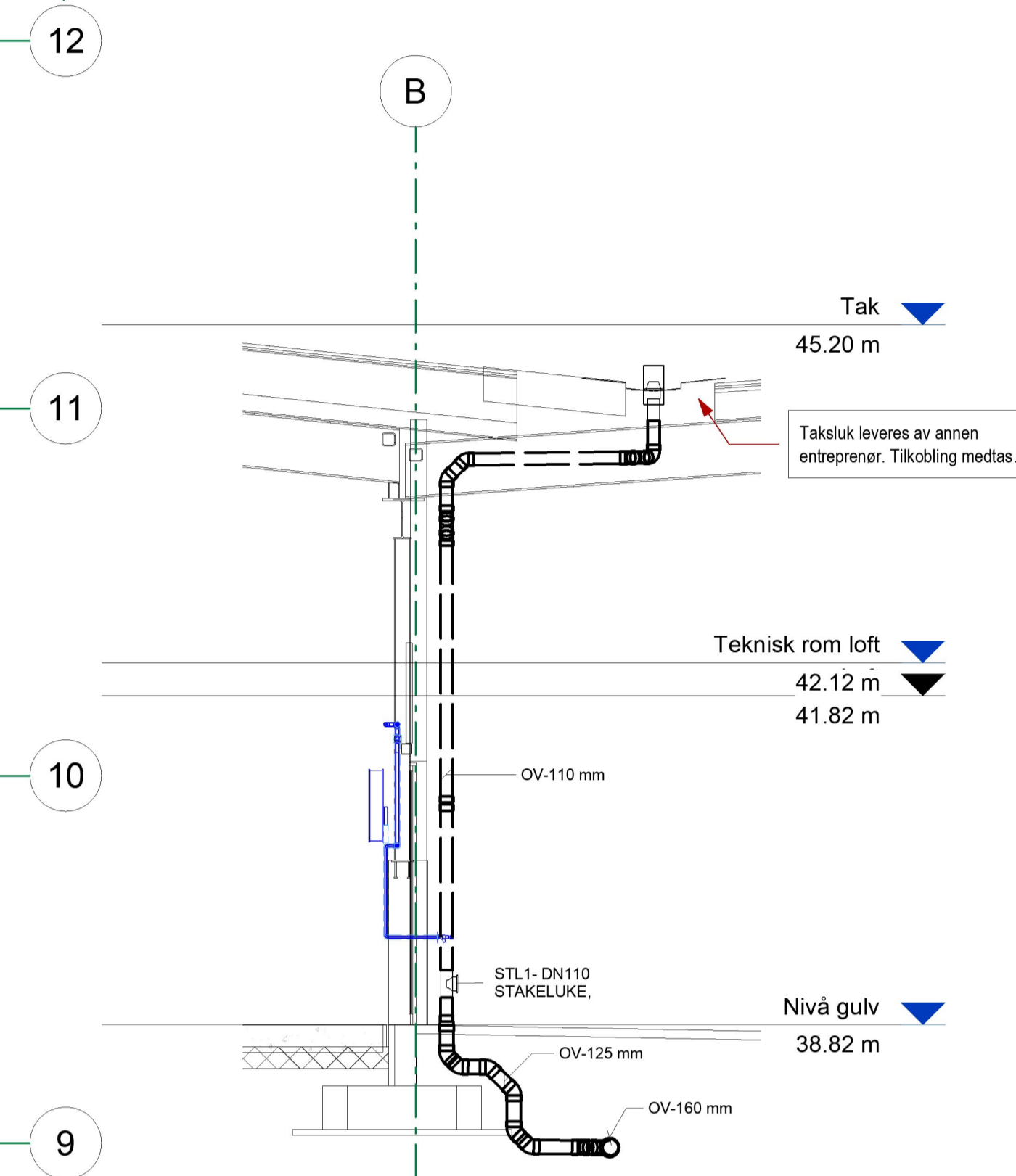

3 Prinsipp taksluk
1 : 50

TEGNFORKLARING		Fig. nr	Rev
Drens	---	V-10-UH-31-01-2022	
Spillvann	---		
Overvann	---		
Radonsikring	---		
Vannledning	---		
Overvannsrenne	---		

Taknedløp 6-13 avsluttes 2.5m over bakkenivå.
Taknedløp 1-5-13 avsluttes ved taksluk

Tilbudstegnning	Totaltpris	ED	SAL	09.02.23
Tilbudstegnning	Byggetinn	ED	SAL	04.04.22
Rev	Revisjonen gjelder	Tegn	Kont	Dato
KARMØY KOMMUNE		ED	SAL	
P56800 - NY GJENVINNSSTASJON BORGAREDALEN		KONTRE	SAL	14.03.22
Overvann fra sedumtak		Årskv	SAL	
		Status	As indicated	
		Prosjekt	TILBUDSTEGNING	
		Prosjekt nr	2321	
		Fig. nr	V-10-UH-31-01-2022	



Ferkingstad og Alsaker



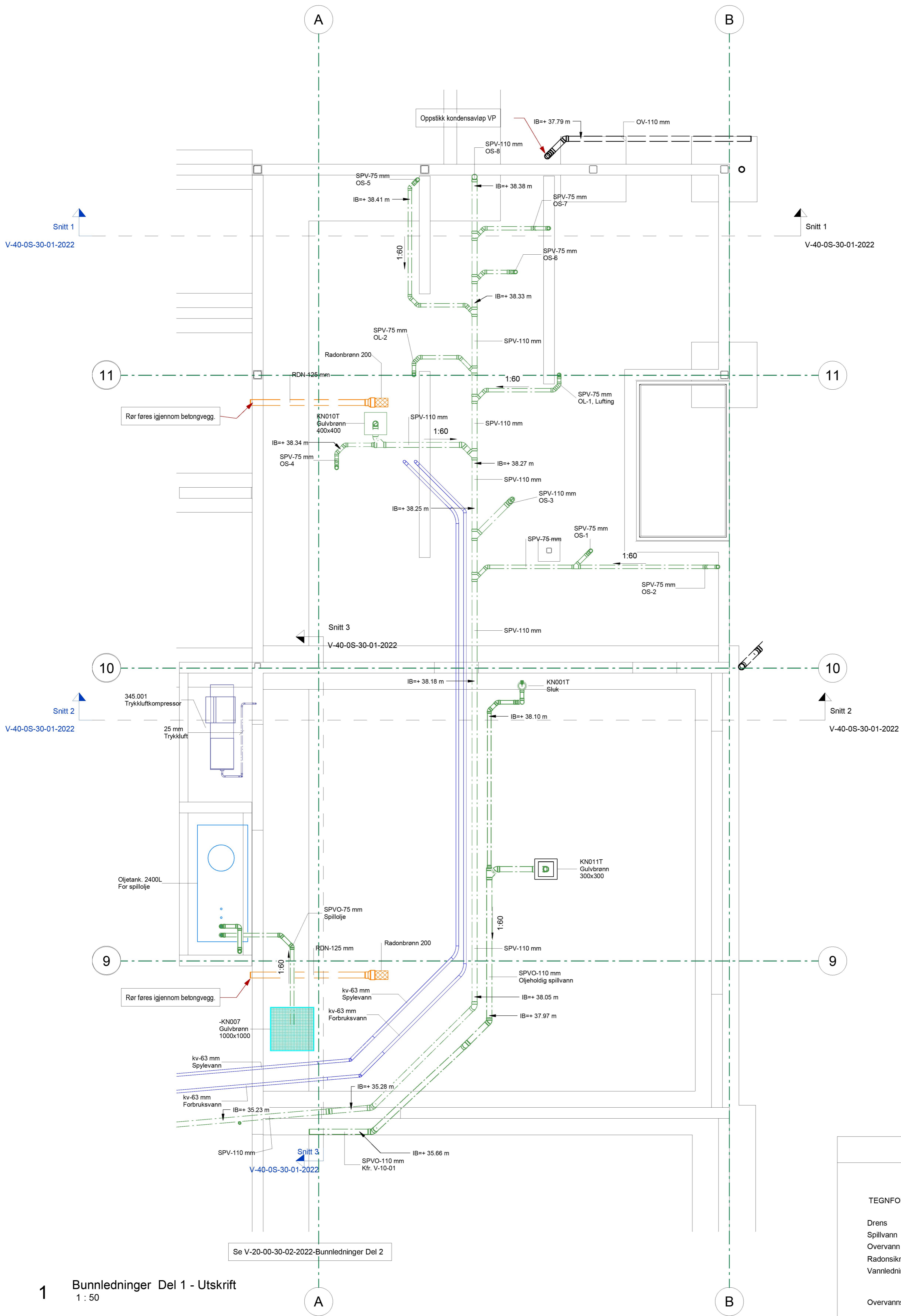

1 Bunnledninger Del 1 - Utskrift
1 : 50

Se V-20-00-30-02-2022-Bunnledninger Del 2

Rev	Tegn. nr	Rev.
	V-20-00-30-01-2022	

- TEGNFORKLARING**
- Drens
 - Spillvann
 - Overvann
 - Radonsikring
 - Vannledning
 - Overvannsrenne

Tilbudstegning Totalentreprise	ED	SAL	09.02.23
Tilbudstegning Byggetrinn HEB	ED	SAL	04.04.22
Rev	Revideringen gjelder		Dato.
	Tegn.	Kontr.	Dato.
KARMØY KOMMUNE			
P56800 - NY GJENVINNINGSTASJON BORGAREDALEN			
Bunnledninger Del 1			
TEGN	ED	DATO	
KONTR	SAL	16.02.22	
Målestokk:	As indicated		
Status:	TILBUDSTEGNING		
Prosj nr	2321		
Tegn. nr	V-20-00-30-01-2022		
Rev.			



F030417 (25/04/21)

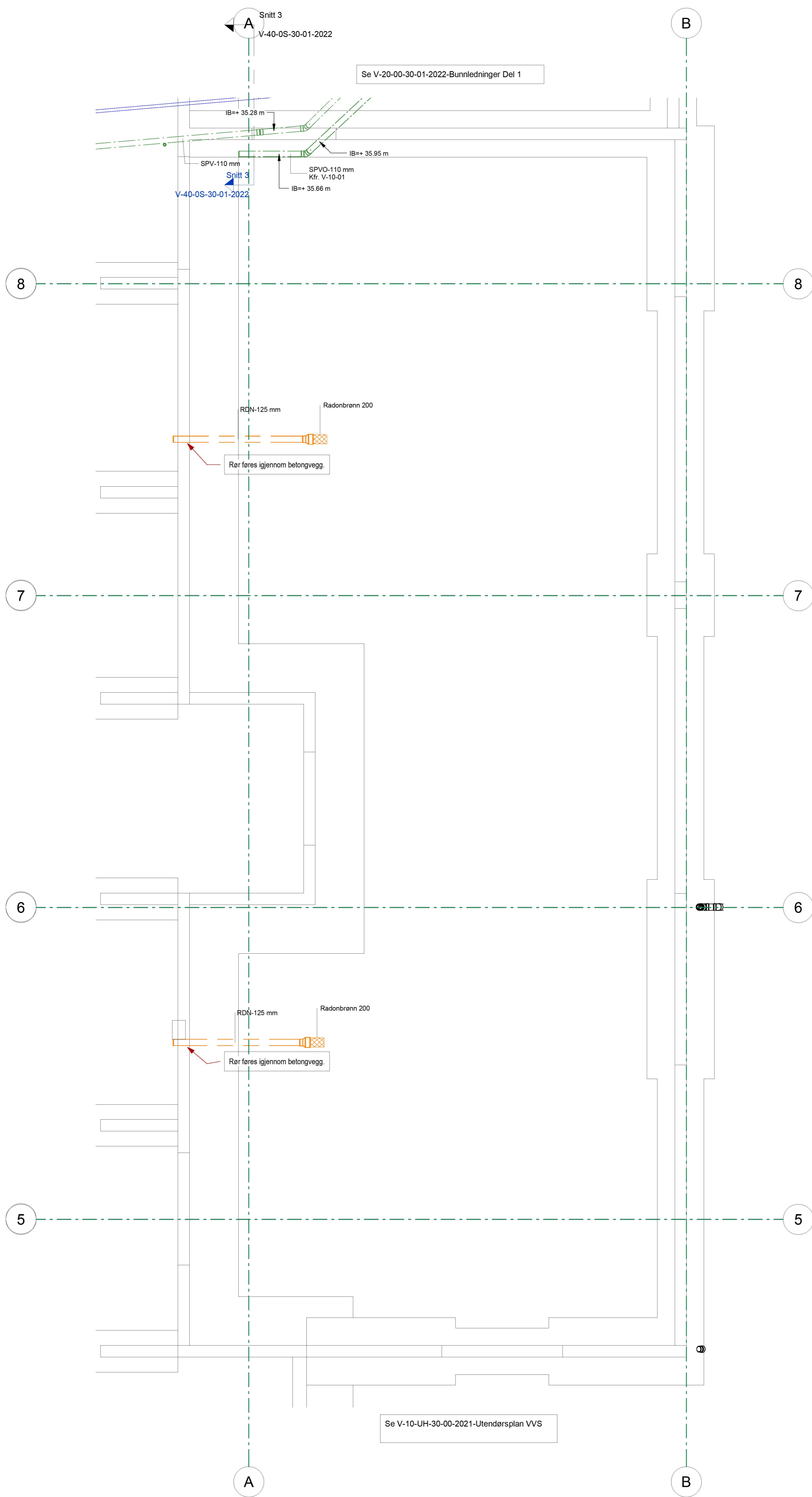

Se V-20-00-30-01-2022-Bunnledninger Del 1

Snitt 3
V-40-0S-30-01-2022

Snitt 3
V-40-0S-30-01-2022

RDN-125 mm Radonbrenn 200

Rør føres igjennom betongvegg.

RDN-125 mm Radonbrenn 200

Rør føres igjennom betongvegg.

Se V-10-UH-30-00-2021-Utendørsplan VVS

1 Bunnledninger Del 2 - Utskrift
1 : 50

Tegn. nr V-20-00-30-02-2022		Rev.
TEGNFORKLARING		
Drens		
Spillvann		
Overvann		
Radonsikring		
Vannledning		
Overvannssrenne		
Rev	Tilbudstegning Totalentreprise	ED
	Tilbudstegning Byggetrinn HEB	SAL
		09.02.23
	Revideringen gjelder	ED
		SAL
		04.04.22
KARMØY KOMMUNE		TEGN
P56800 - NY GJENVININGSSTASJON BORGAREDALEN		ED
Bunnledninger Del 2		KONTR
		SAL
		DATO
		16.02.22
Målestokk:		As indicated
Status:		TILBUDSTEGNING
Prosj. nr		2321
Tegn. nr		V-20-00-30-02-2022
Rev.		



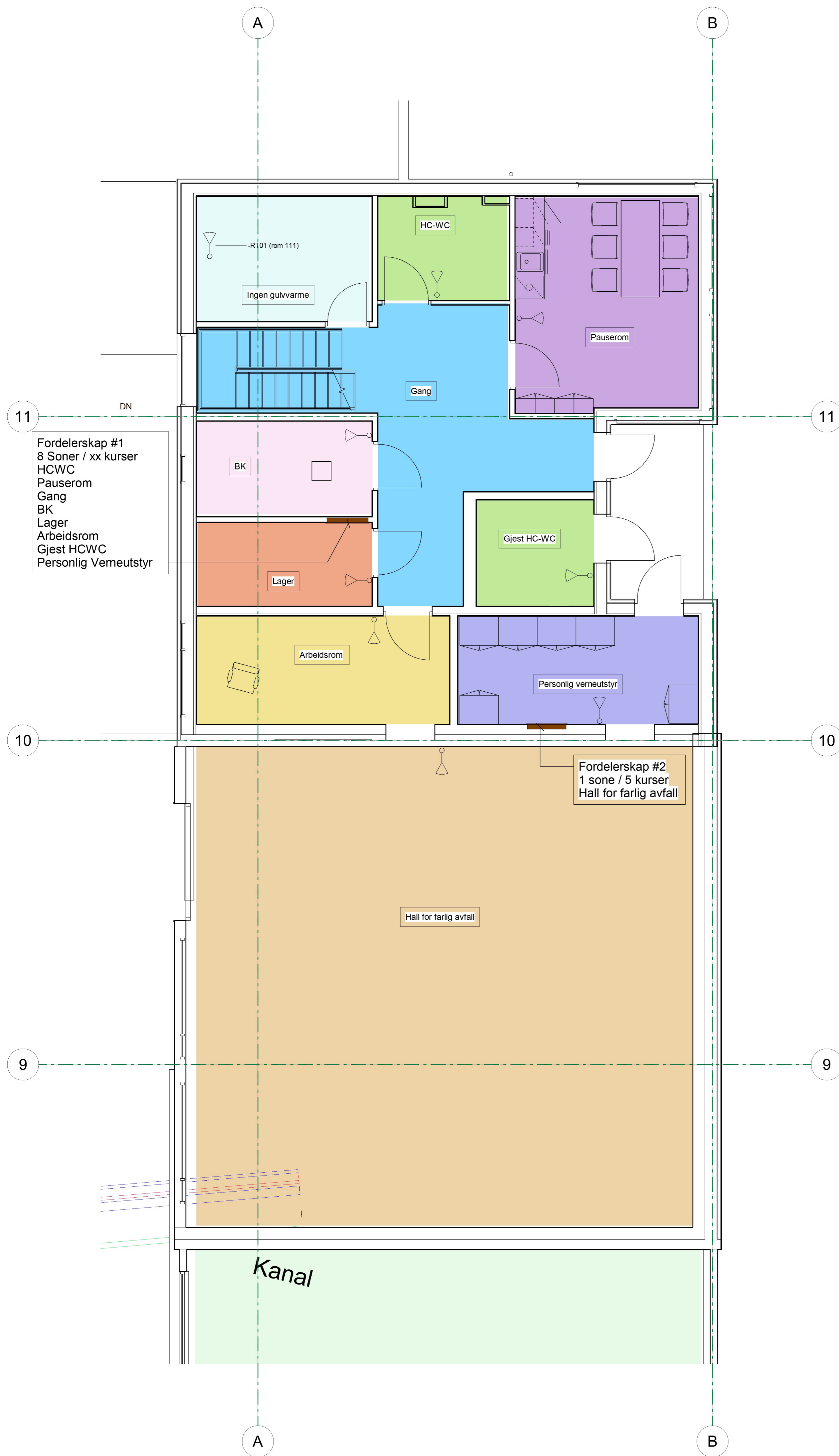

- Fordelerskap #1
- 8 Soner / xx kurser
- HCWC
- Pauserom
- Gang
- BK
- Lager
- Arbeidsrom
- Gjest HCWC
- Personlig Verneutstyr

Rev	Tilbudstegning Byggetrinn HEB	Tegn.	ED	DATO	09.02.23
		Kontr.	SAL	Dato.	04.04.22

Tilbudstegning Totalentreprise		ED	SAL	09.02.23
Tilbudstegning Byggetrinn HEB		ED	SAL	04.04.22
Rev	Revideringen gjelder	Tegn.	Kontr.	Dato.
KARMØY KOMMUNE		TEGN	ED	DATO
P56800 - NY GJENVININGSSTASJON BORGAREDALEN		KONTR	SAL	DATO
Gulvvarme Del 1		Målestokk:	1 : 50	
Status:		TILBUDSTEGNING		
Prosj nr		2321		
Tegn nr		V-20-00-32-01-2022		
Rev.				



Ferkingstad og Alsaker
RÅDGIVENDE INGENIØRER VVS
Karmsundgt. 159 - 5522 Haugesund - Tlf 52 70 53 80



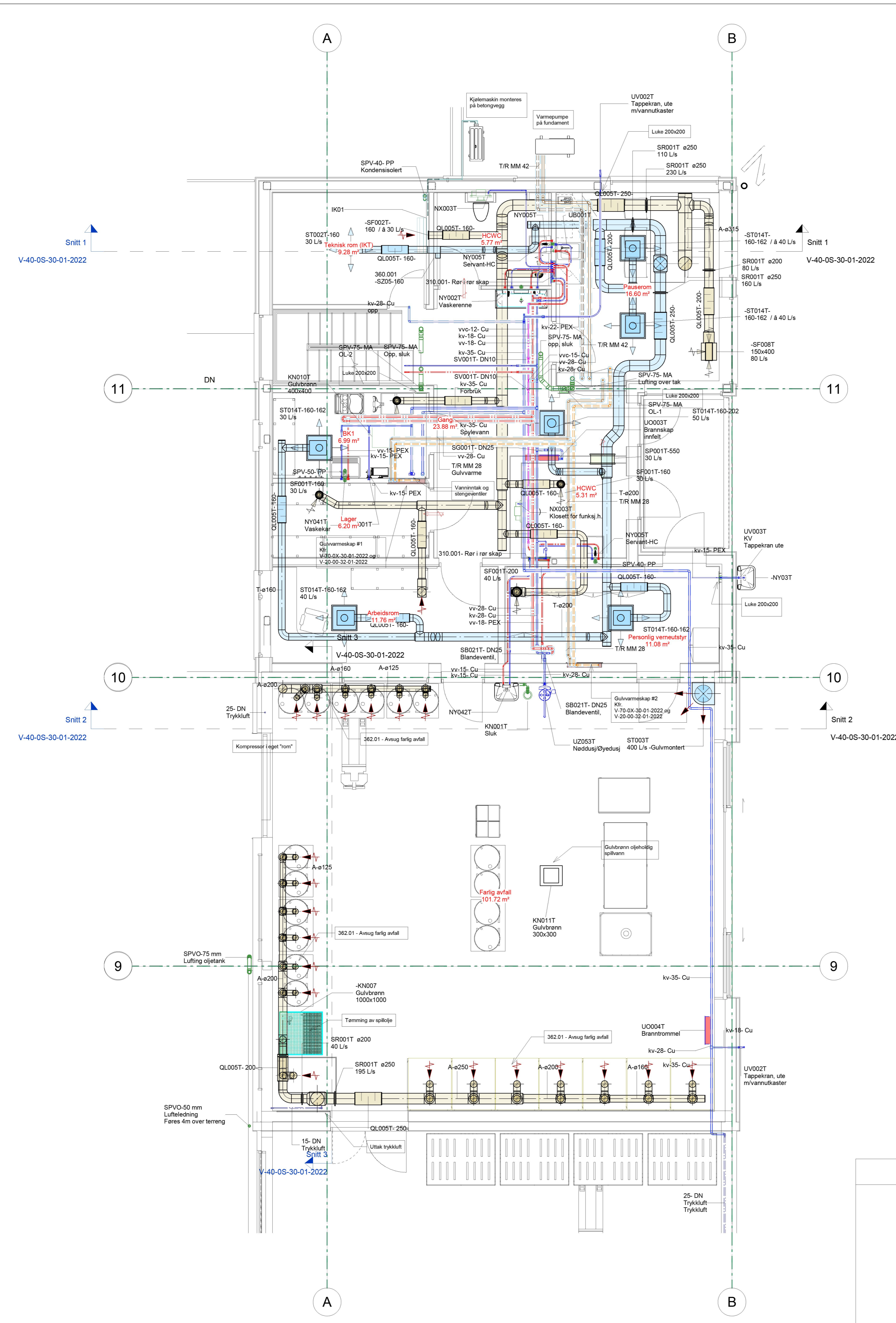

Tegn. nr V-20-01-30-01-2022		Rev.								
<table border="1"> <tr> <td>Tilbudstegning Totalentreprise</td> <td>ED</td> <td>SAL</td> <td>09.02.23</td> </tr> <tr> <td>Tilbudstegning Byggetrinn HEB</td> <td>ED</td> <td>SAL</td> <td>04.04.22</td> </tr> </table>			Tilbudstegning Totalentreprise	ED	SAL	09.02.23	Tilbudstegning Byggetrinn HEB	ED	SAL	04.04.22
Tilbudstegning Totalentreprise	ED	SAL	09.02.23							
Tilbudstegning Byggetrinn HEB	ED	SAL	04.04.22							
Rev		Revideringen gjelder								
Tegn.		Kontr.								
Tegn.		Dato								
KARMØY KOMMUNE		ED								
P56800 - NY GJENVINNINGSTASJON BORGAREDALEN		KONTR.								
Plan 1.etg Del 1		SAL								
		Dato								
		Målestokk:								
		1 : 50								
		Status:								
		TILBUDSTEGNING								
		Prosj nr								
		2321								
		Tegn. nr								
		V-20-01-30-01-2022								
		Rev.								



KARMØY KOMMUNE

RÅDGIVENDE INGENIØRER VVS

Karmsundgt. 159 - 5522 Haugesund - Tlf 52 70 53 80



Ferkingsstad og Alsaker

RÅDGIVENDE INGENIØRER VVS

Karmsundgt. 159 - 5522 Haugesund - Tlf 52 70 53 80



FCB/MAT: (254641)

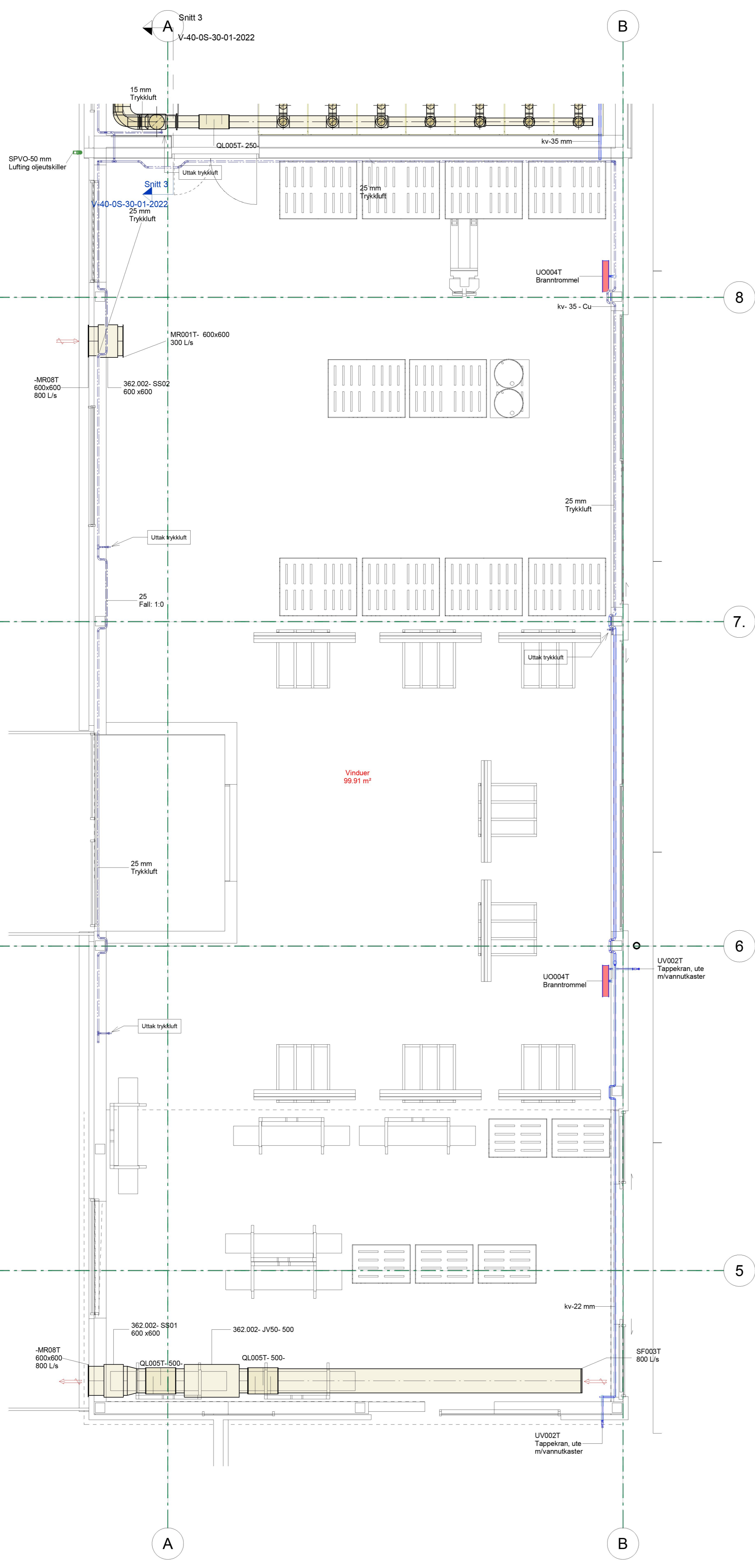

Rev	Tegn. nr	Dato
	V-20-01-30-02-2022	04.04.22

Tilbudstegning Totalentreprise		ED	SAL	09.02.23
Tilbudstegning Byggetrinn HEB		ED	SAL	04.04.22
Rev		Tegn.	Kontr.	Dato.
KARMØY KOMMUNE		ED	DATO	
P56800 - NY GJENVININGSSTASJON BORGAREDALEN		KONTR.	SAL	DATO 16.02.22
Plan 1.etg Del 2		Målestokk:	1 : 50	
Status:		TILBUDSTEGNING		
Prosj nr		2321		
Tegn. nr		V-20-01-30-02-2022		
Rev.				



KARMØY KOMMUNE
RÅDGIVENDE INGENIØRER VVS
Karmsundgt. 159 - 5522 Haugesund - Tlf 52 70 53 80



Ferkingstad og Alsaker
Tilbudstegning

FORBILT (254641)

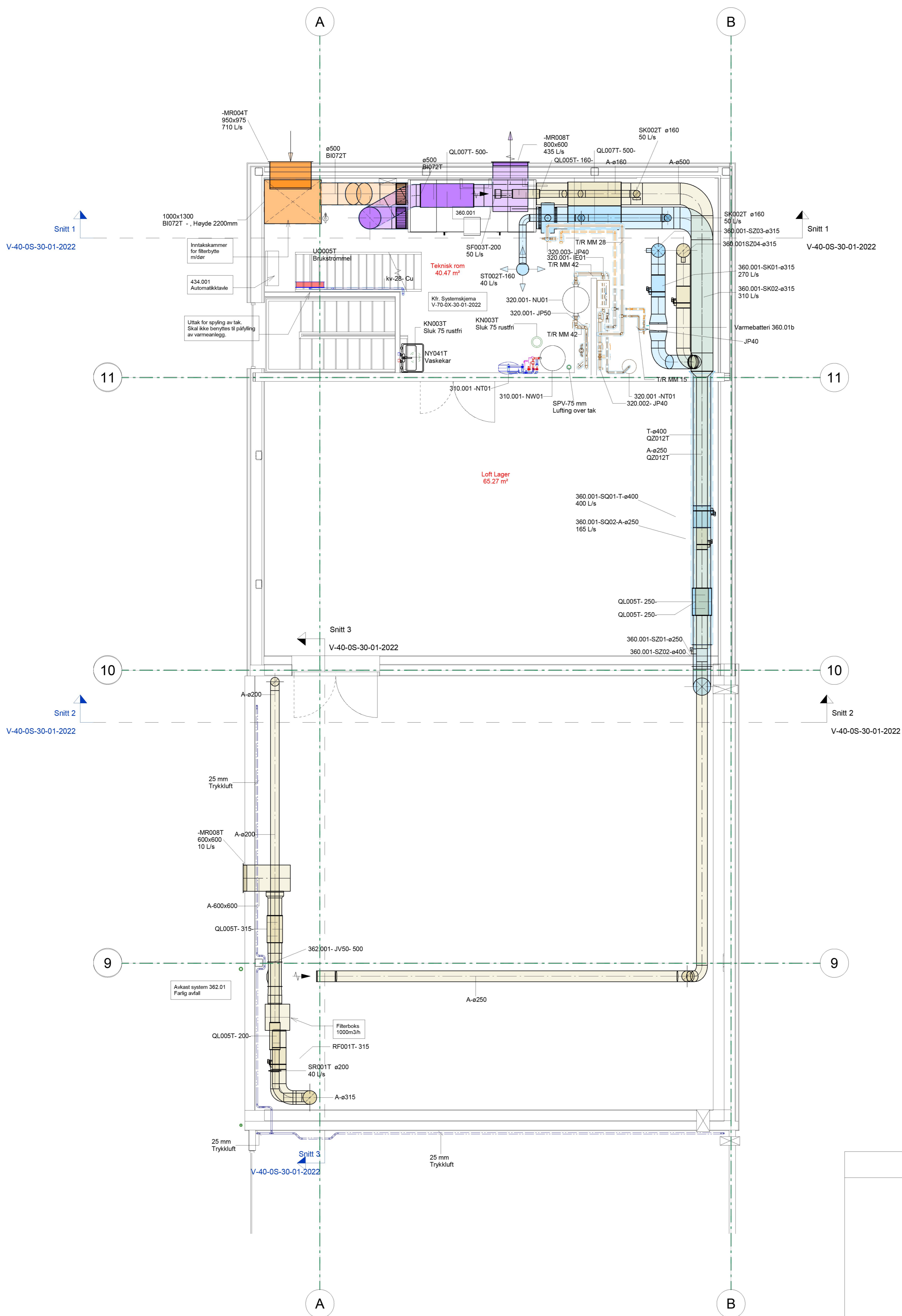

Tegn. nr	V-20-02-30-01-2022	Rev.	
----------	--------------------	------	--

Tilbudstegning Totalentreprise	ED	SAL	09.02.23
Tilbudstegning Byggetrinn HEB	ED	SAL	04.04.22
Rev	TEGN	KONTR	DATO
	ED	SAL	16.02.22
Målestokk:	1 : 50		
Status:	TILBUDSTEGNING		
Prosj nr	2321		
Tegn. nr	V-20-02-30-01-2022	Rev.	



Ferkingstad og Alsaker
RÅDGIVENDE INGENIØRER VVS
Karmsundgt. 159 - 5522 Haugesund - Tlf 52 70 53 80



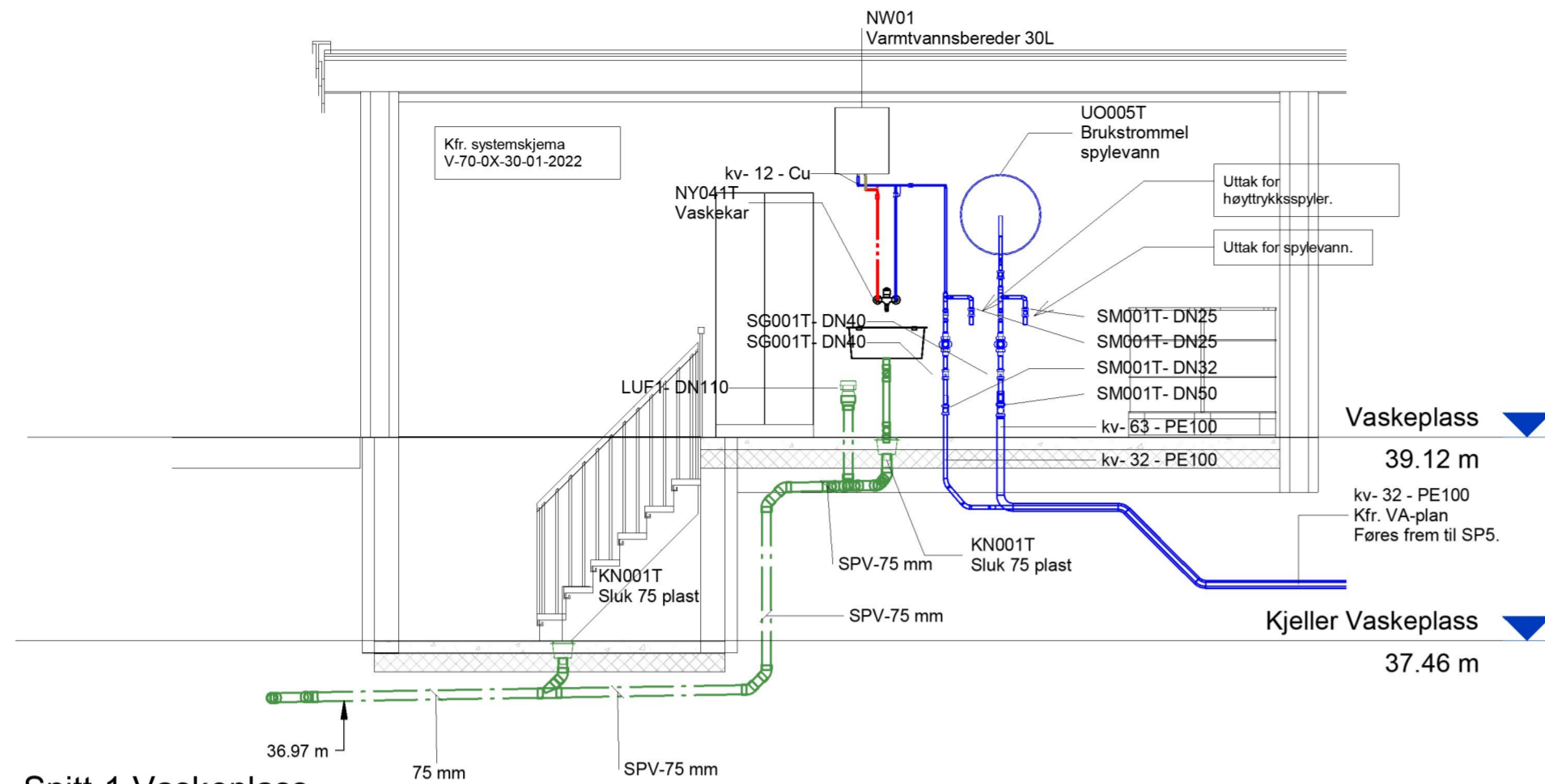

4 Snitt-1 Vaskeclass
1 : 50

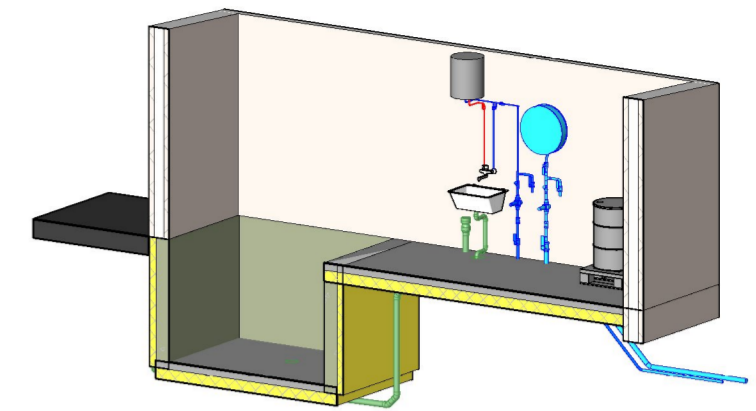

3 3D Vaskeclass

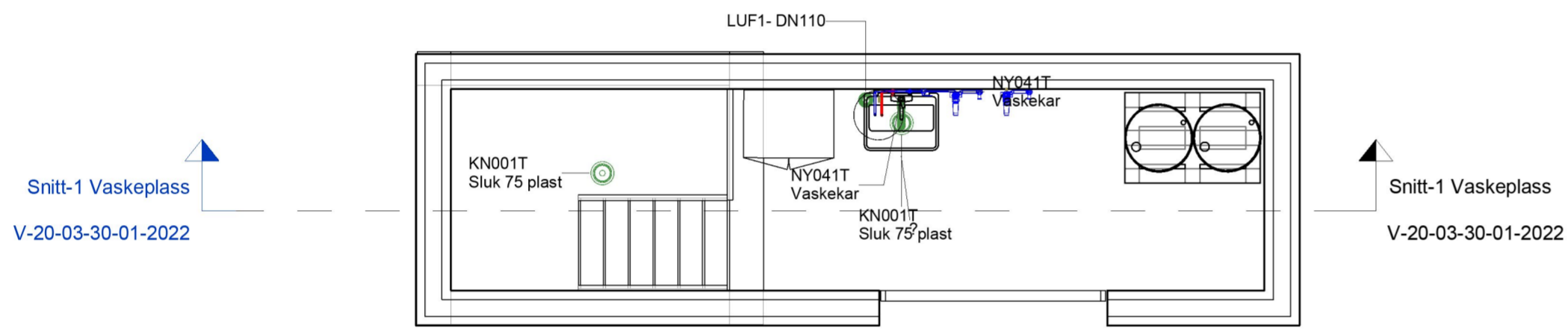

1 1.etg. Vaskeclass Utskrift
1 : 50

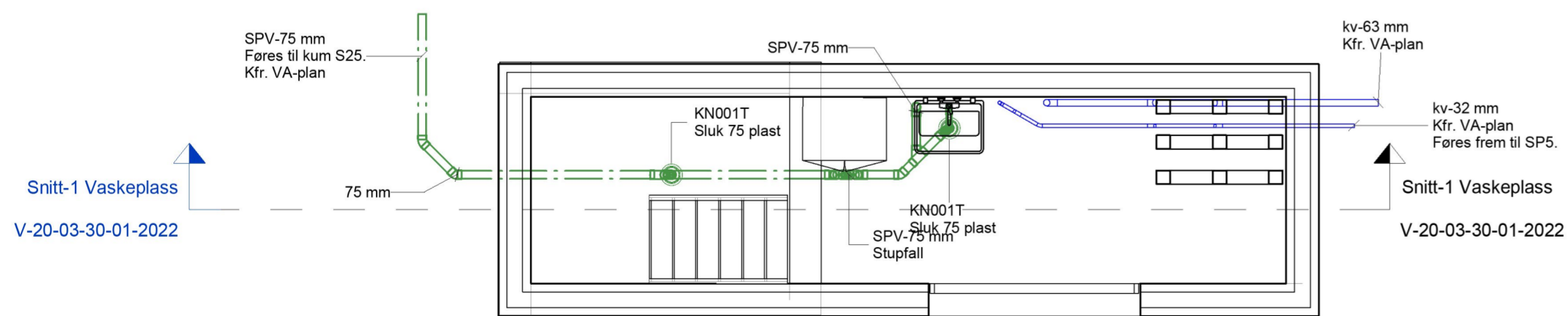

2 Bunnledninger Vaskeclass Utskrift
1 : 50

Tegn. nr	Rev.
V-20-03-30-01-2022	

Tilbudstegning Totalentreprise	ED	SAL	09.02.23
Tilbudstegning Byggetrinn HEB	ED	SAL	04.04.22
Rev	TEGN.	KONTR.	DATO
	ED		
KARMØY KOMMUNE		KONTR.	DATO
P56800 - NY GJENVINNGSSTASJON BORGAREDALEN		SAL	16.02.22
Plan og snitt Vaskeclass		Målestokk:	1 : 50
		Status:	TILBUDSTEGNING
		Prosj.nr	2321
		Tegn. nr	V-20-03-30-01-2022
		Rev.	



Ferkingstad og Alsaker
RÅDGIVENDE INGENIØRER VVS
Karmsundgt.159 - 5522 Haugesund - Tlf 52 70 53 60



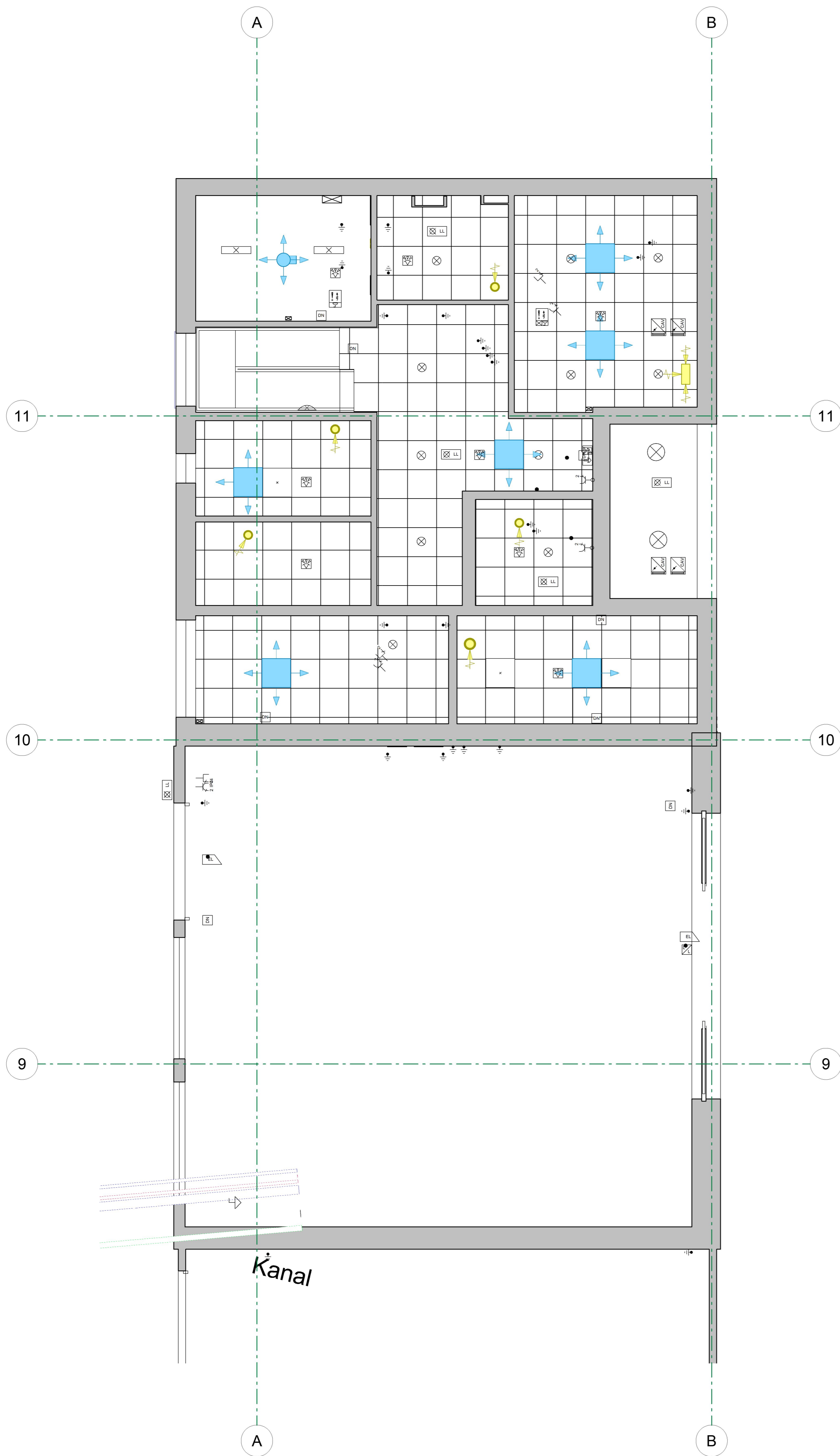

Rev	Tegn. nr	Rev.
	V-30-01-30-01-2022	

Tilbudstegning Totalentreprise	ED	SAL	09.02.23
Tilbudstegning Byggetrinn HEB	ED	SAL	04.04.22
Rev	Revideringen gjelder	Tegn.	Kontr.
		ED	DATO
		KONTR.	DATO
		SAL	16.02.22
		Målestokk:	1 : 50
		Status:	TILBUDSTEGNING
		Prosj nr	2321
		Tegn. nr	V-30-01-30-01-2022
		Rev.	



KARMØY KOMMUNE
 RÅDGIVENDE INGENIØRER VVS
 Karmundgt. 159 - 5522 Haugesund - Tlf 52 70 53 80



Ferkingstad og Alsaker
 RÅDGIVENDE INGENIØRER VVS
 Karmundgt. 159 - 5522 Haugesund - Tlf 52 70 53 80

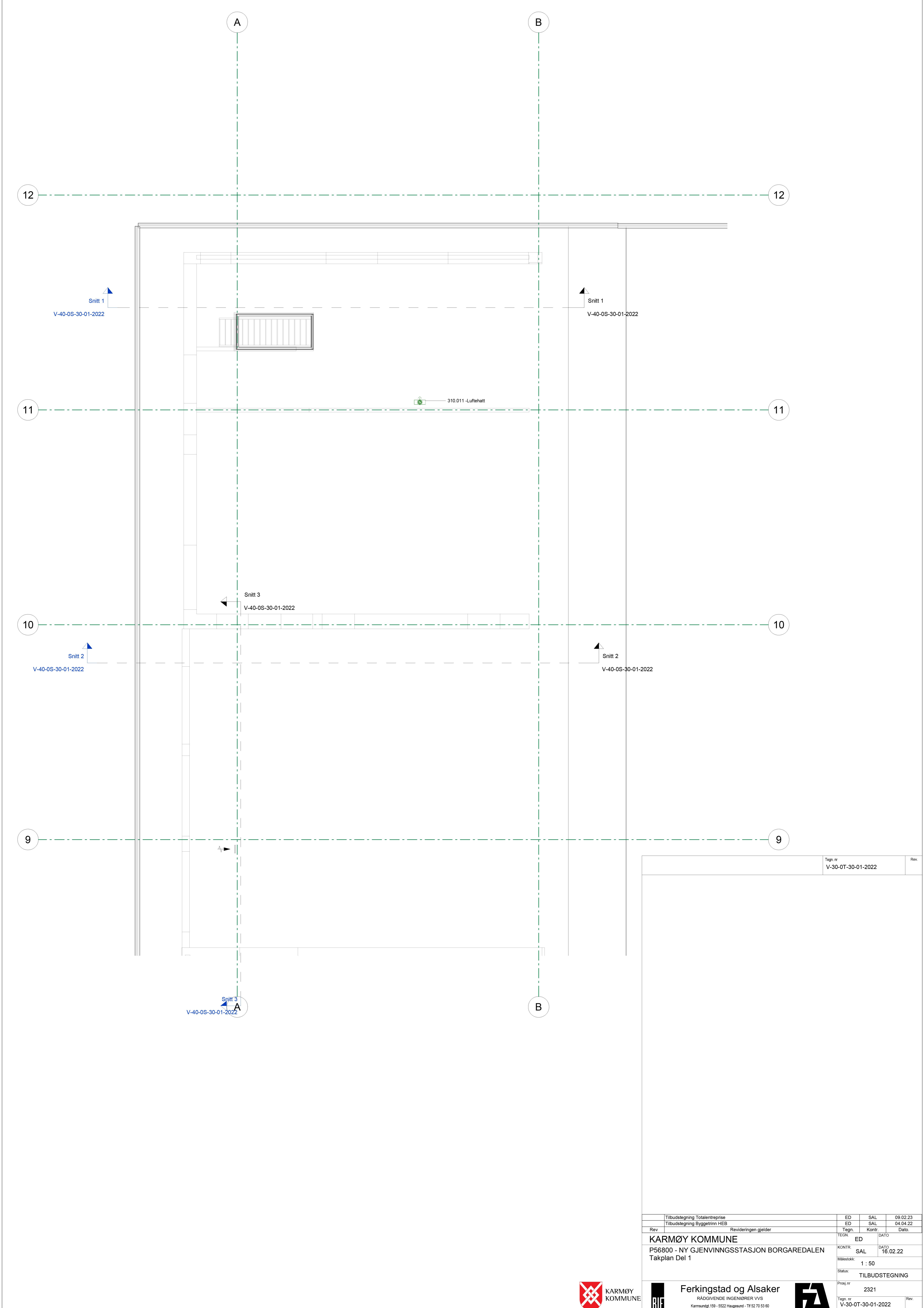

Tegn. nr	V-30-OT-30-01-2022	Rev.
----------	--------------------	------

Tilbudstegning Totalentreprise	ED	SAL	09.02.23
Tilbudstegning Byggetrinn HEB	ED	SAL	04.04.22
Rev	Revideringen gjelder	Tegn.	Kontr.
KARMØY KOMMUNE		TEGN	ED
P56800 - NY GJENVININGSSTASJON BORGAREDALEN		KONTR	SAL
Takplan Del 1		DATO	16.02.22
Målestokk:	1 : 50	Status:	TILBUDSTEGNING
Prosj nr	2321	Tegn. nr	V-30-OT-30-01-2022
Rev.		Rev.	



Ferkingstad og Alsaker
RÅDGIVENDE INGENIØRER VVS
Karmsundgt. 159 - 5522 Haugesund - Tlf 52 70 53 80



FCB/MT: (25/04/21)

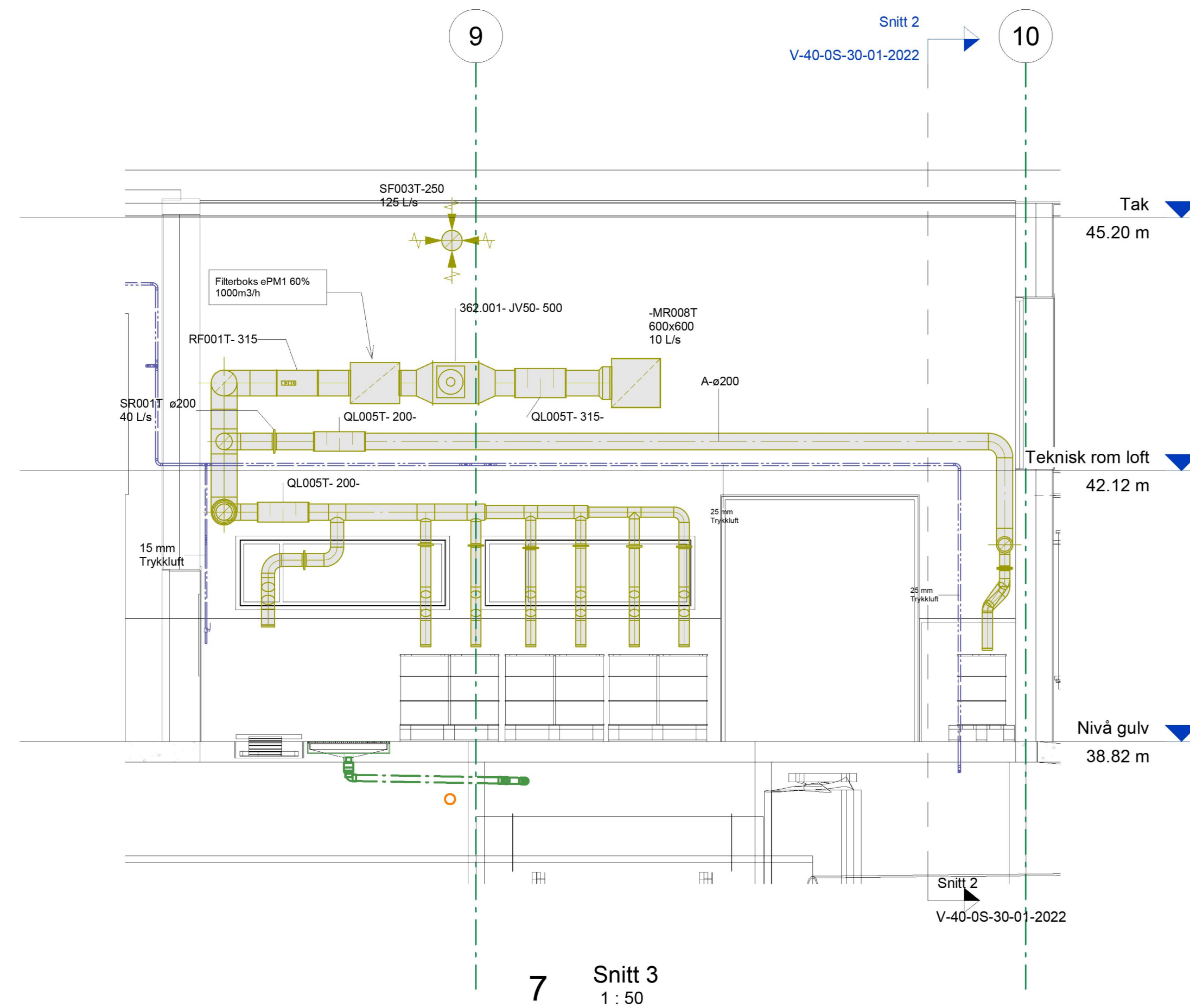
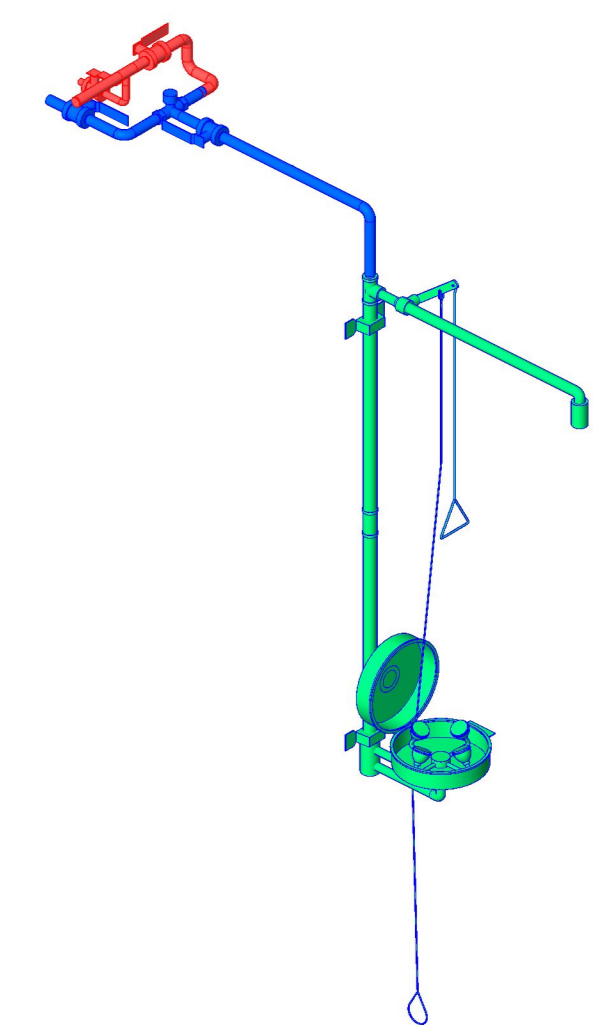
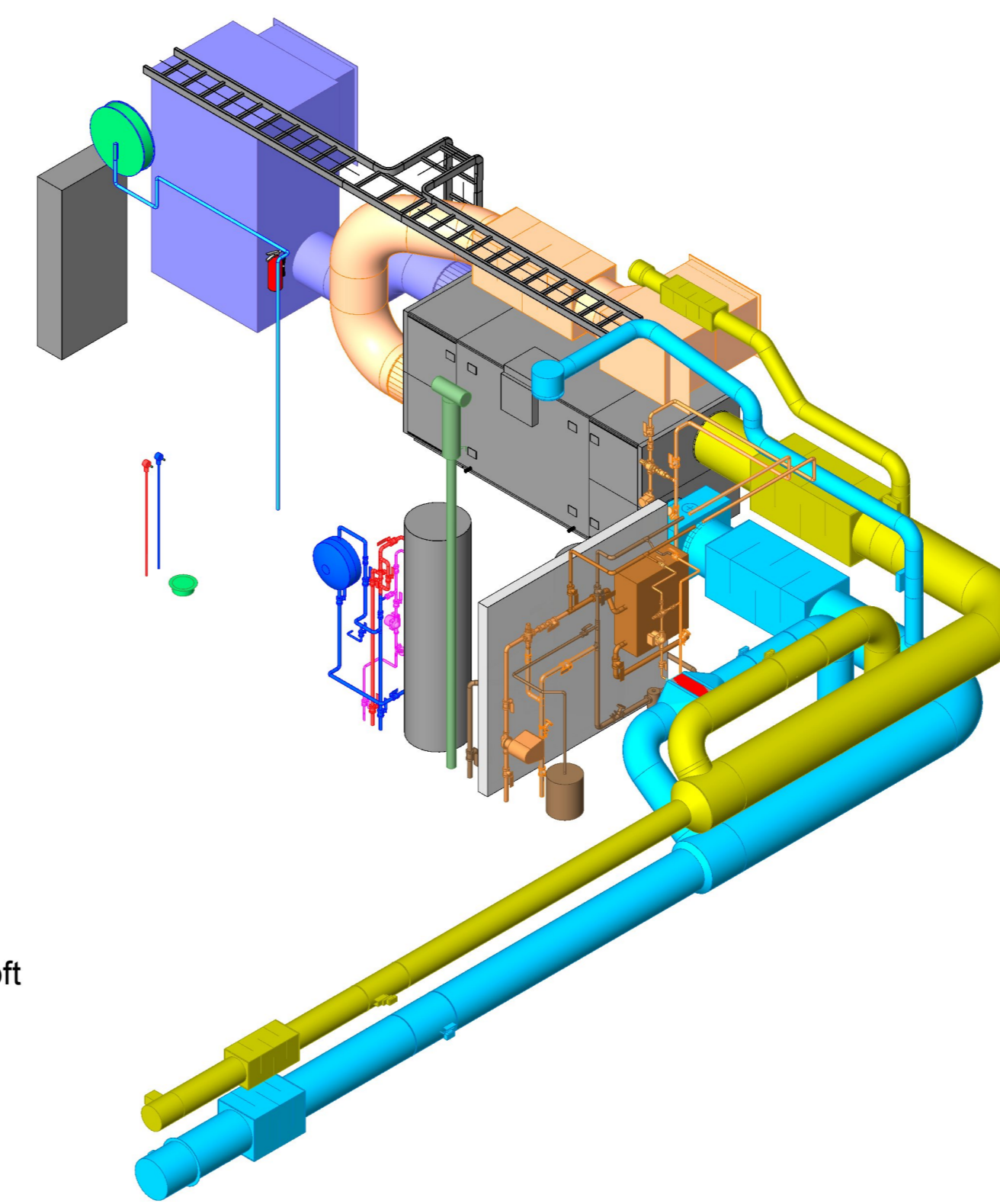
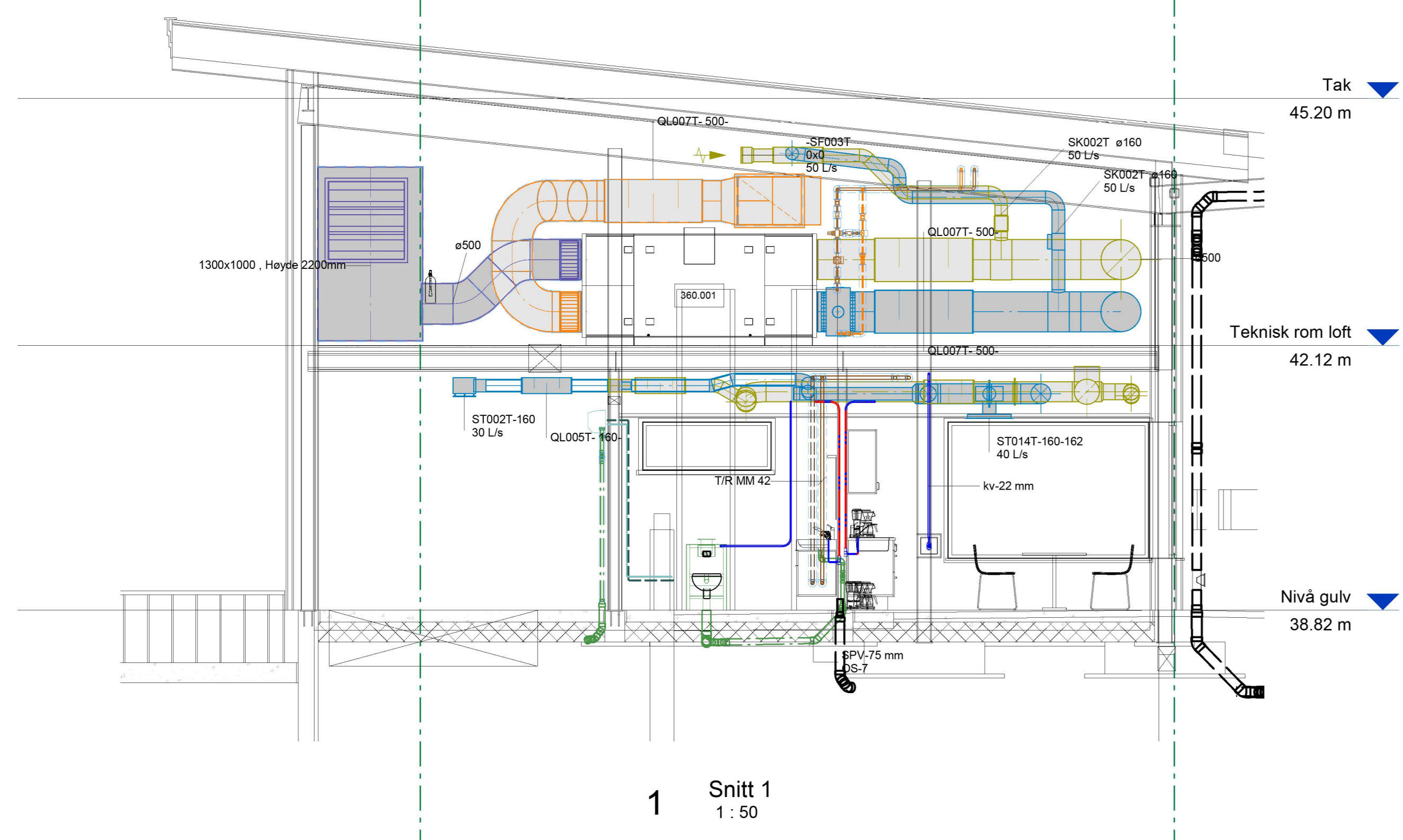
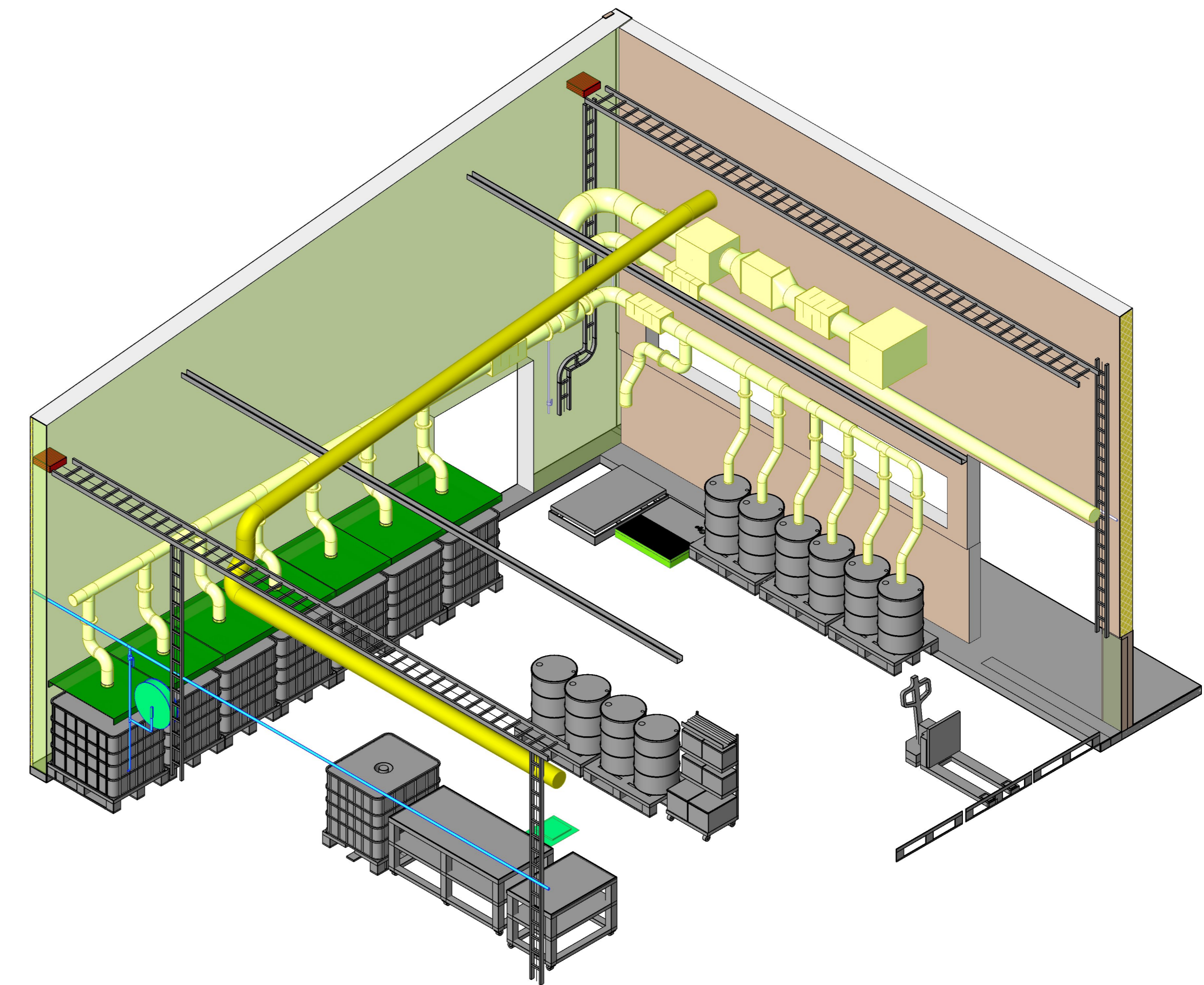
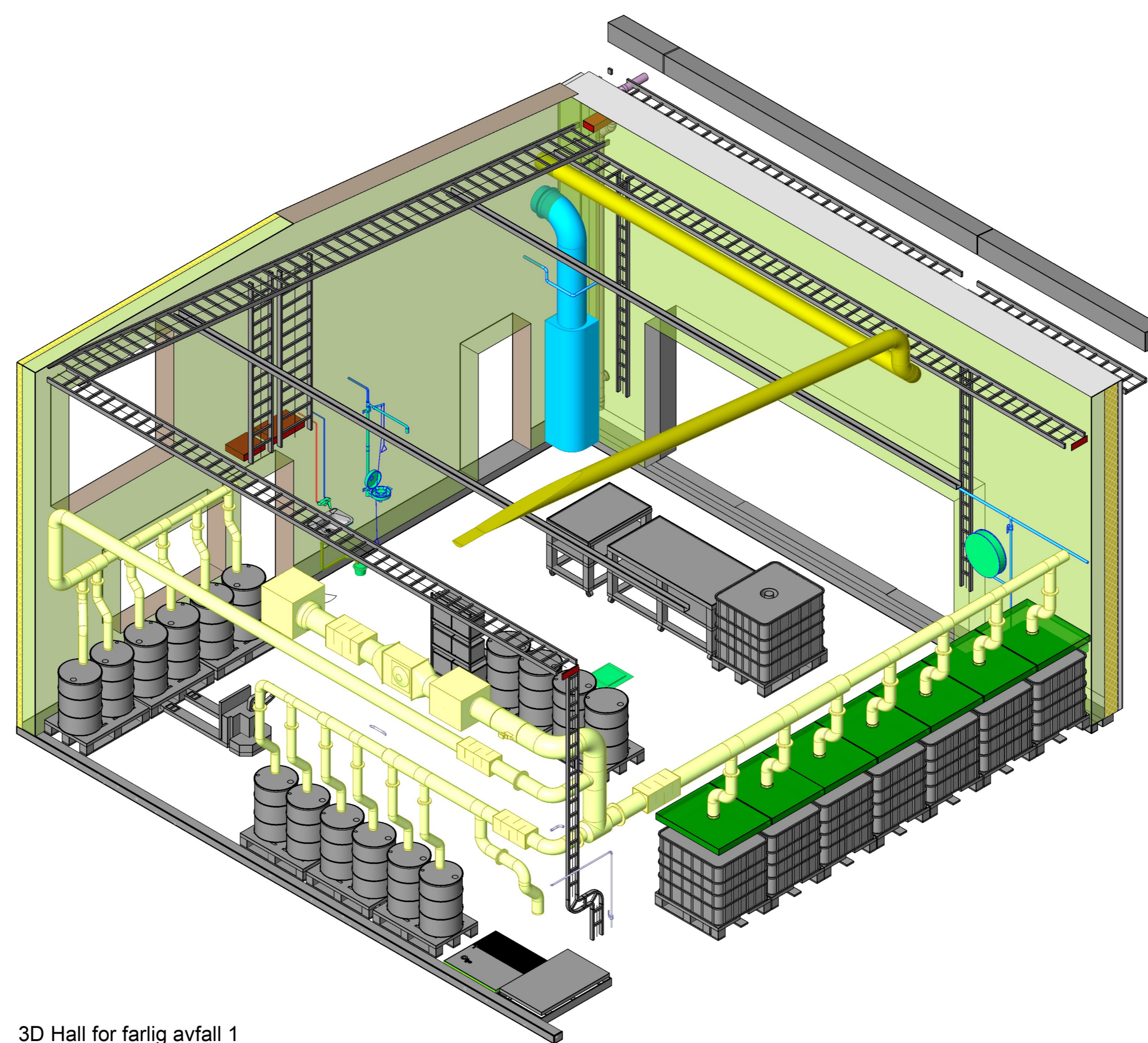
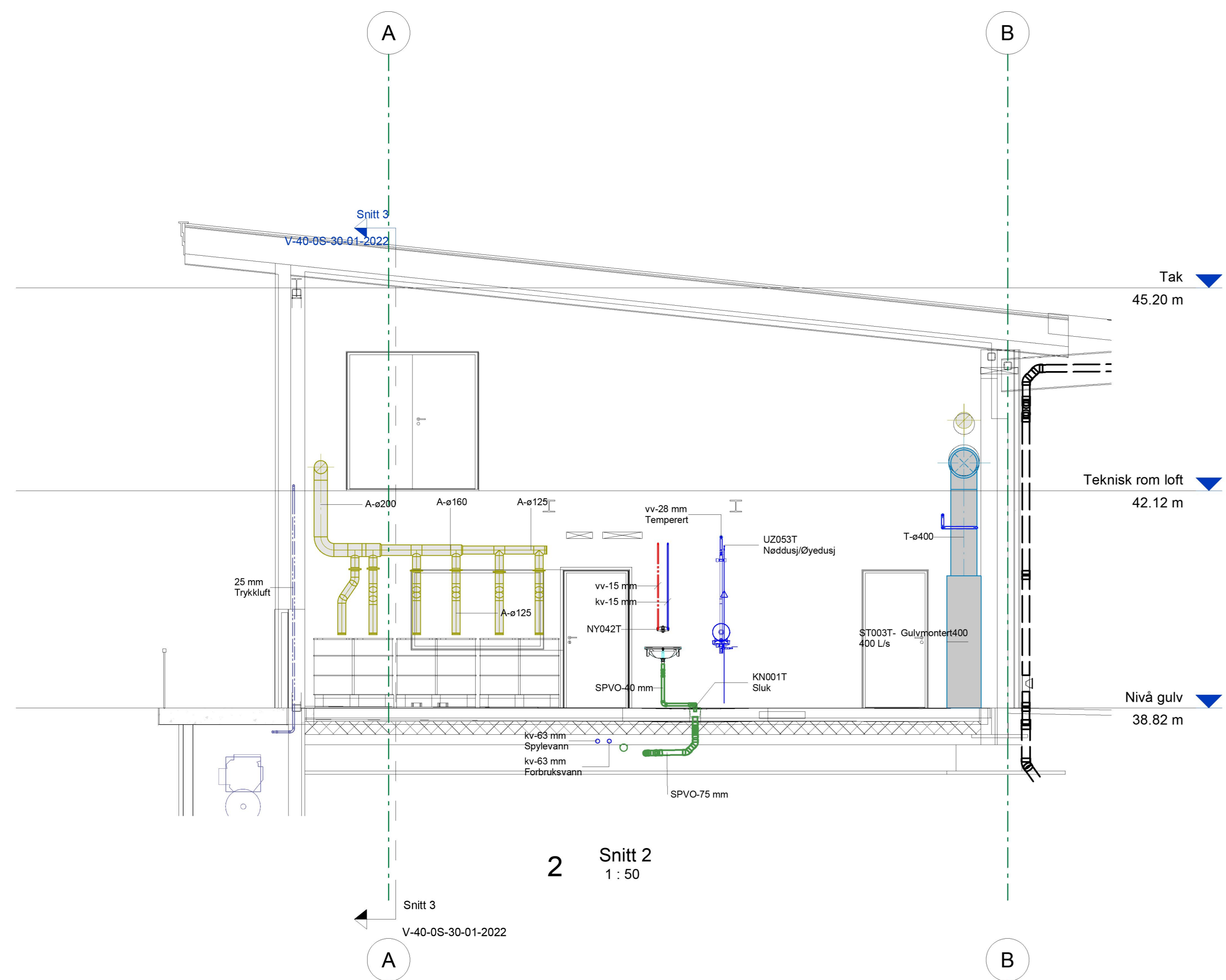

Rev	Rev	Rev	Rev
1	1	1	1
2	2	2	2
3	3	3	3
4	4	4	4
5	5	5	5
6	6	6	6
7	7	7	7
8	8	8	8
9	9	9	9
10	10	10	10

Tilbudstegnning Totalentreprise	ED	SAL	09.02.22
Tilbudstegnning Ergonomi HSB	ED	SAL	04.04.22
Revisjonen gjelder	Tegn	Kont	Dato
KARMØY KOMMUNE	ED	SAL	15.02.22
P56800 - NY GJENVINNINGSTASJON BORGAREDALEN	SAL	SAL	16.02.22
Snitt & 3D	Målestokk	1:50	
	Statistikk	TIL GJENNOMSYN	
	Prosjekt nr	2321	
	Oppdragsnr	V-40-05-30-01-2022	



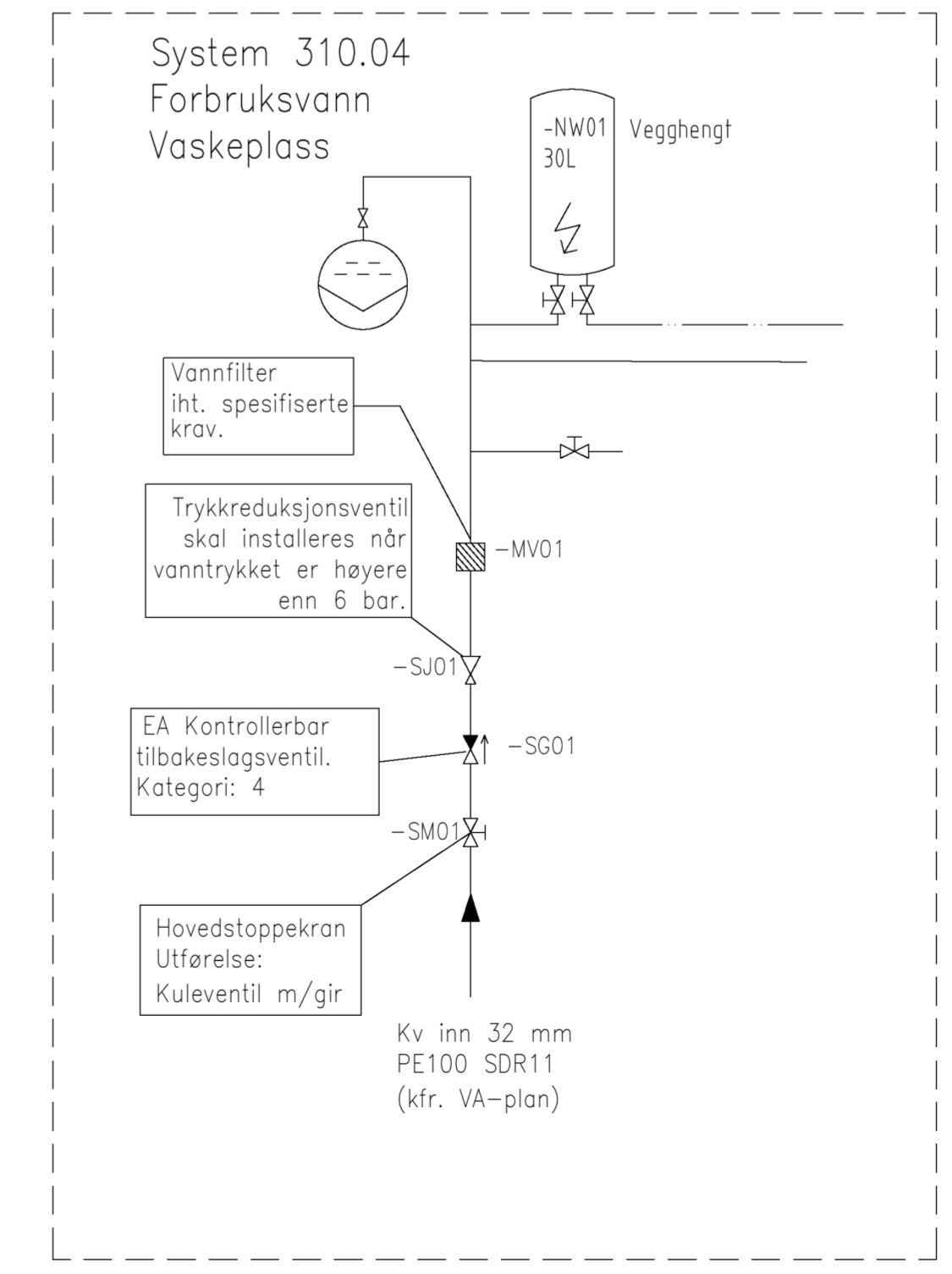
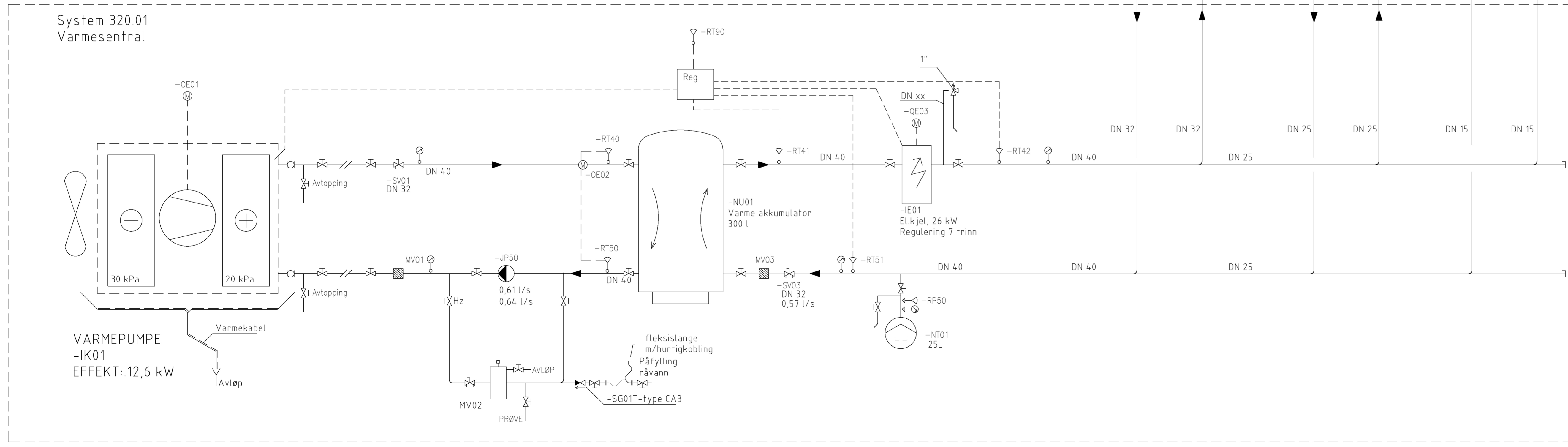
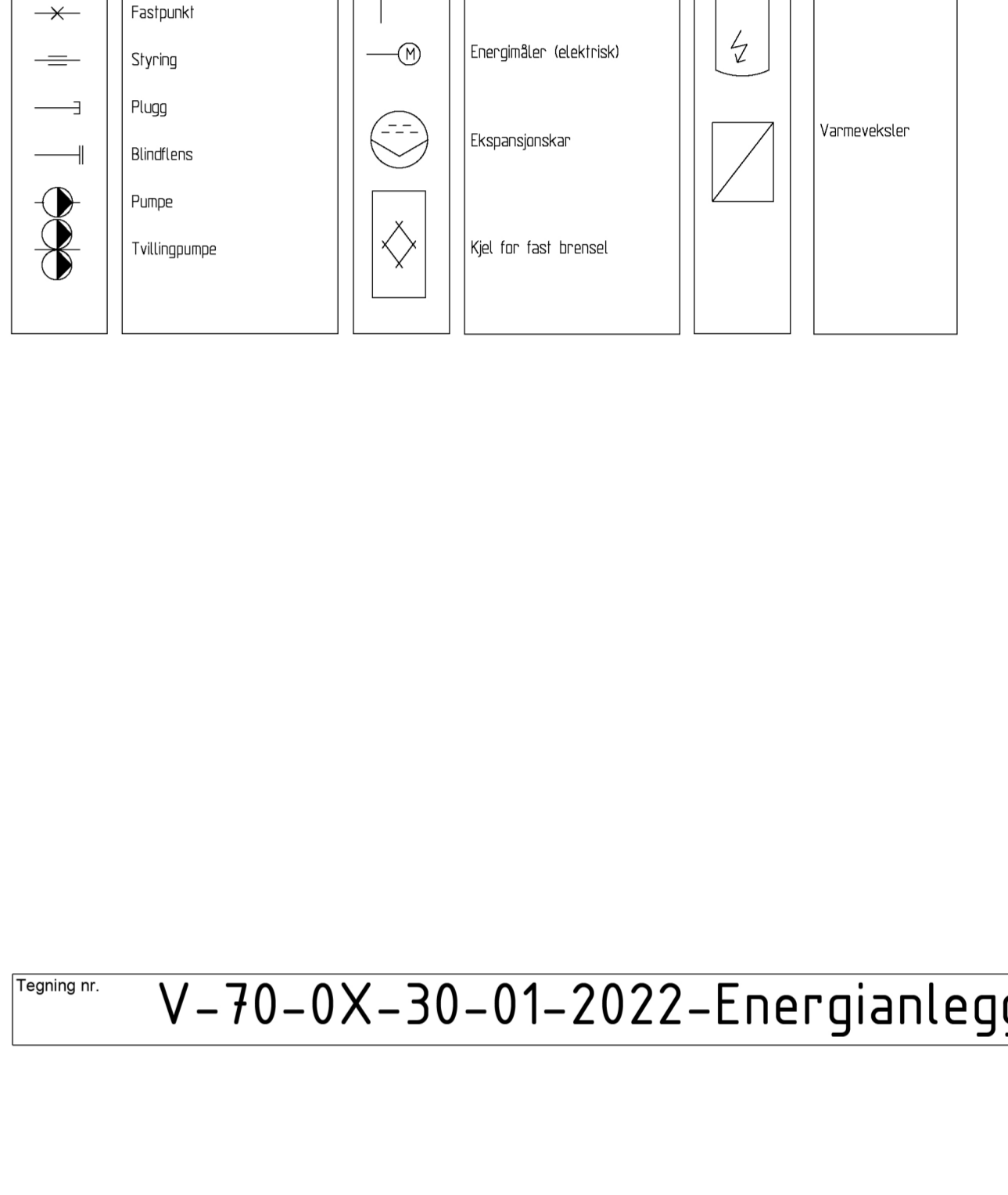
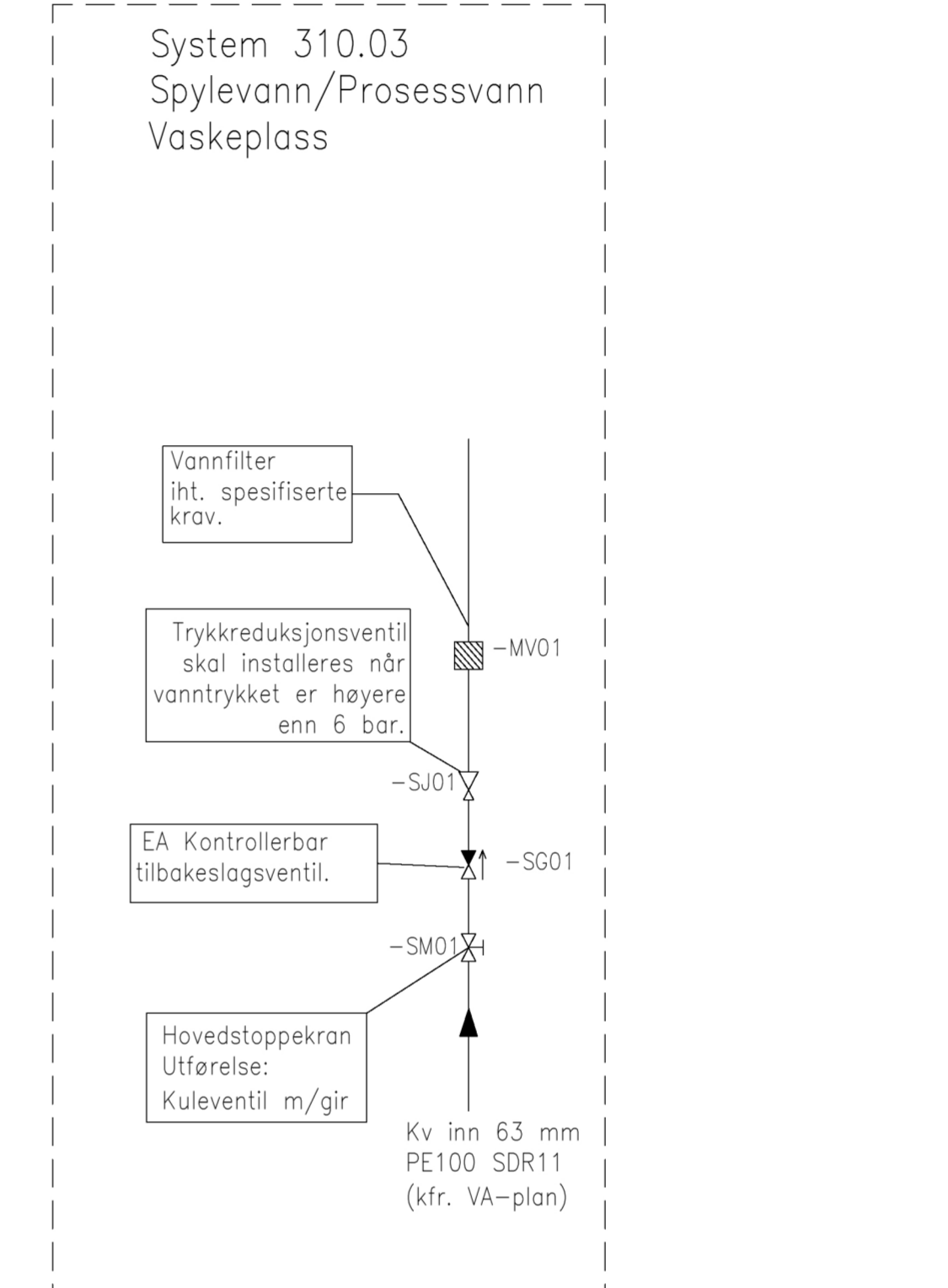
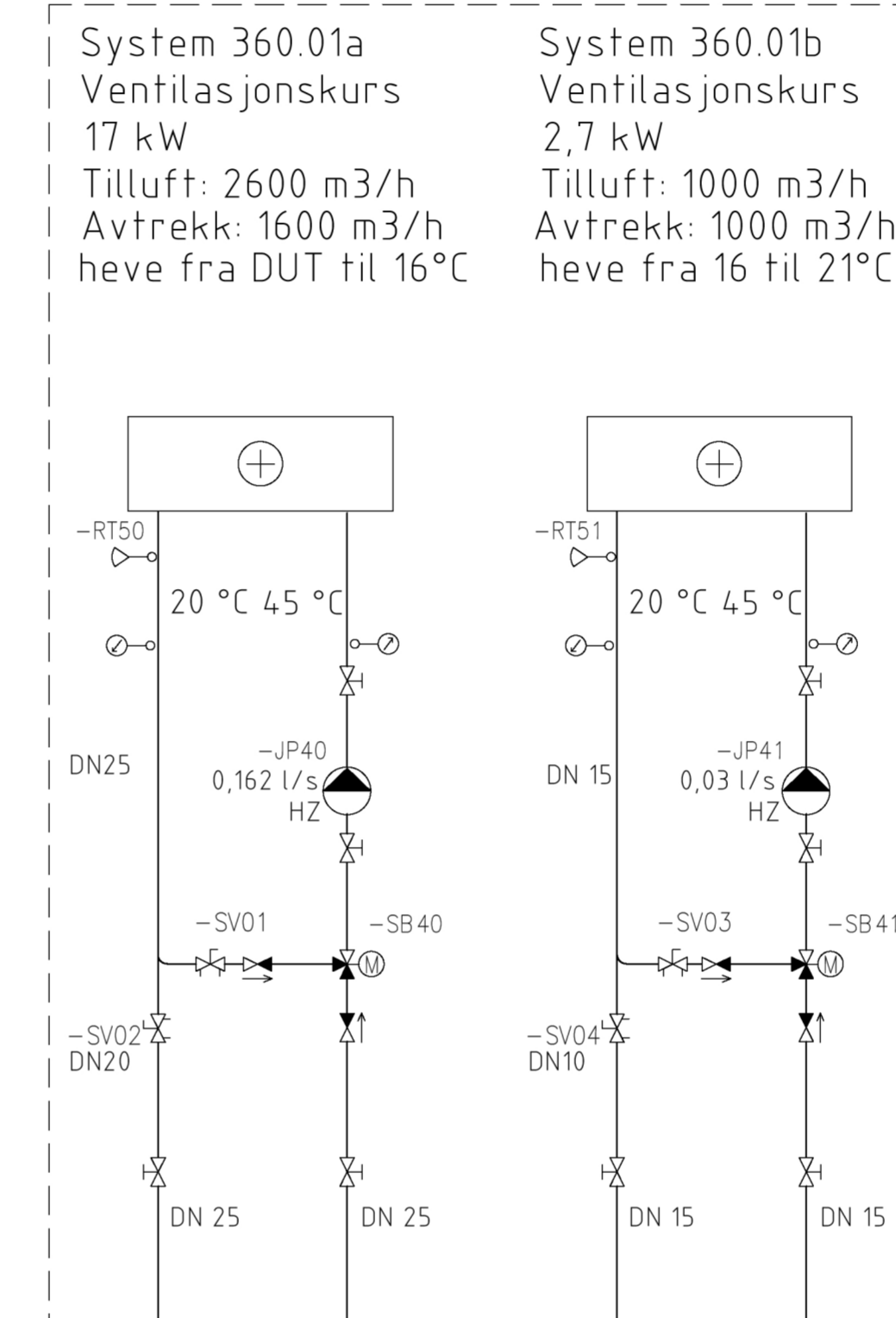
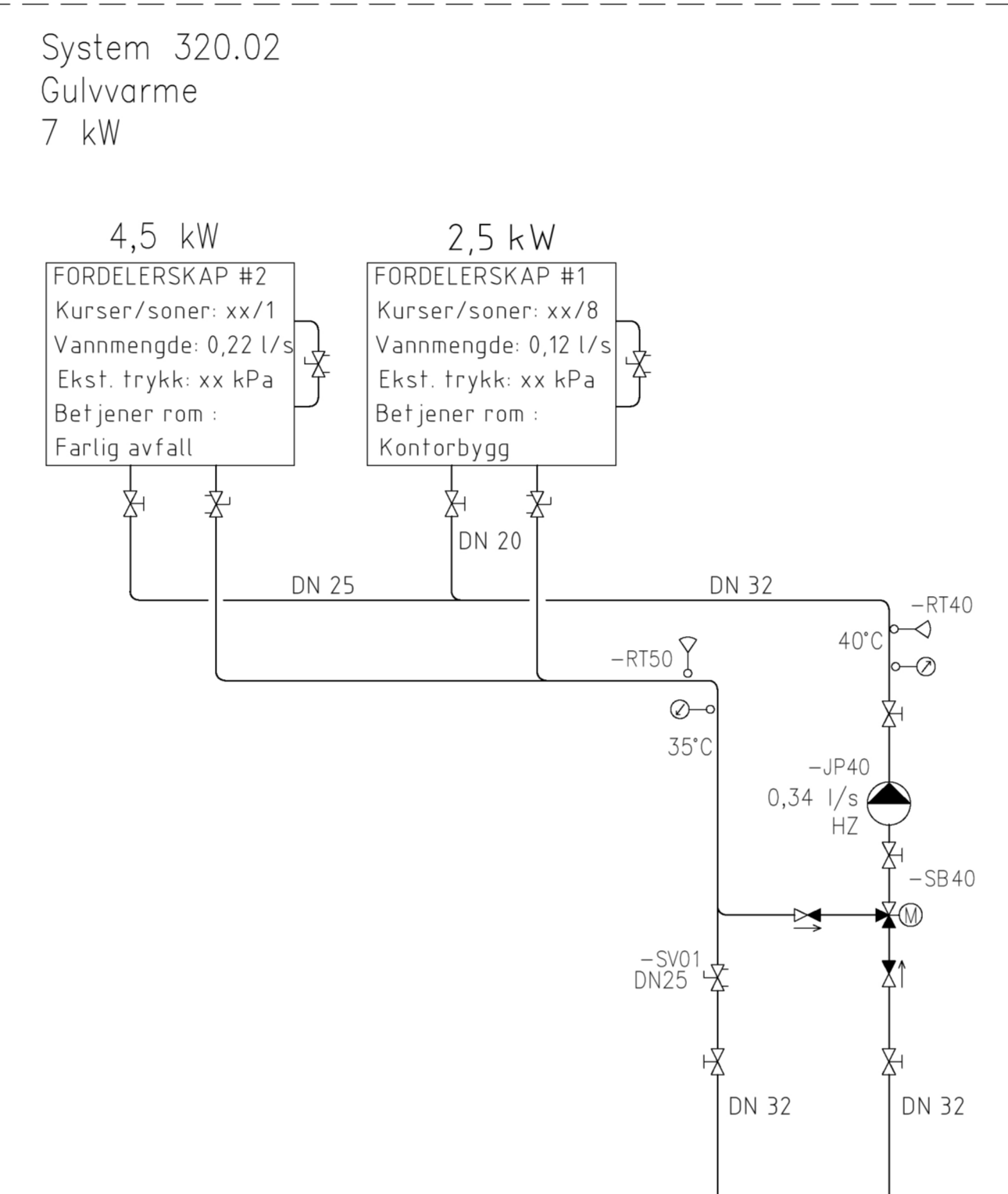
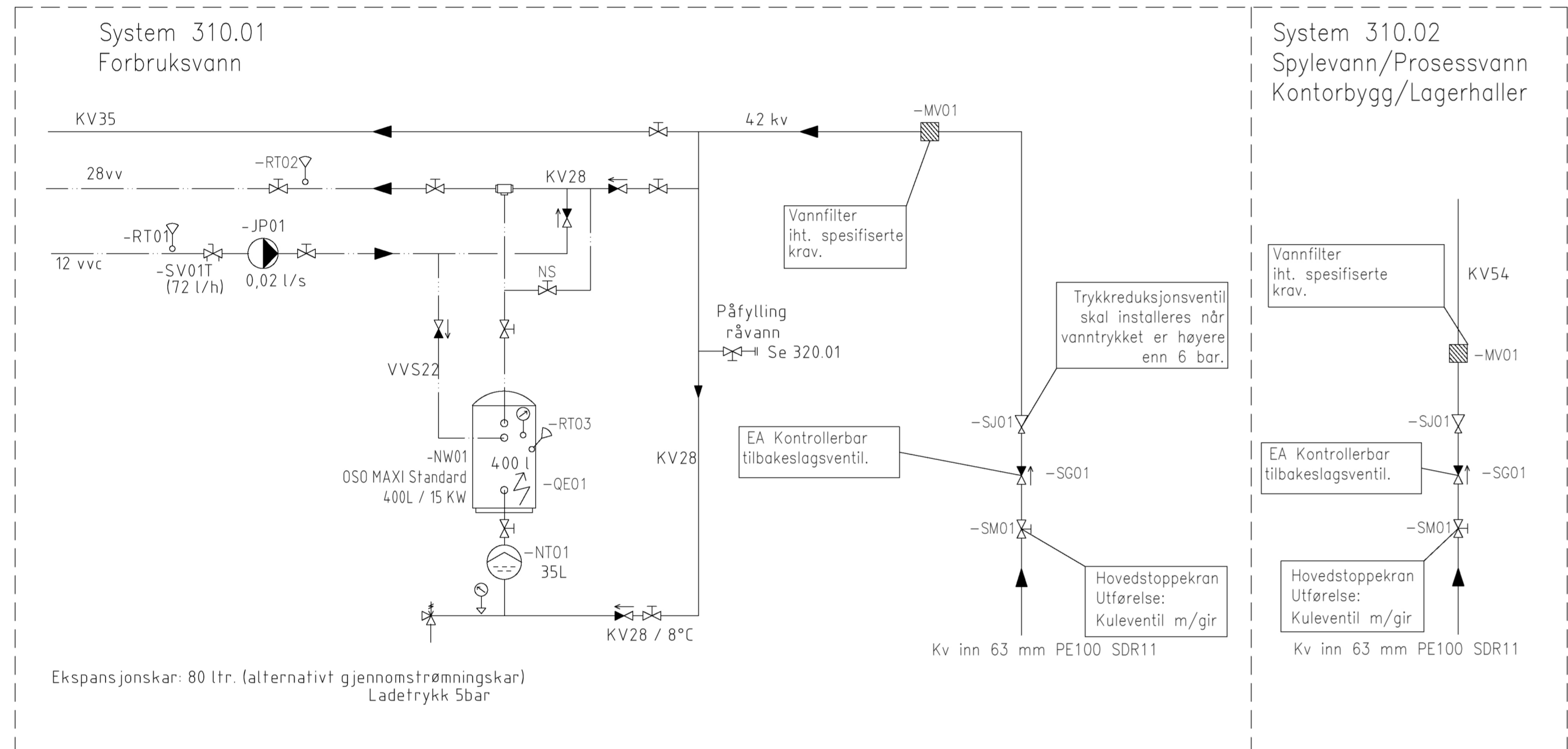
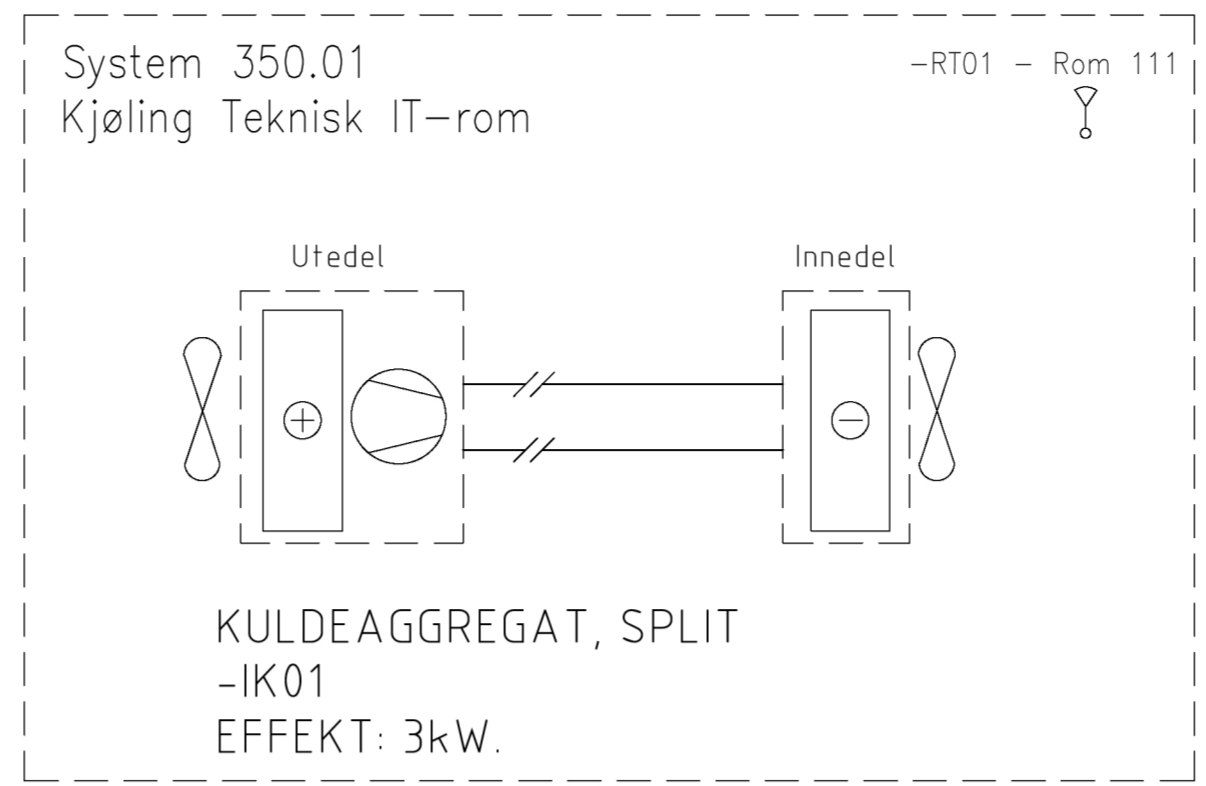
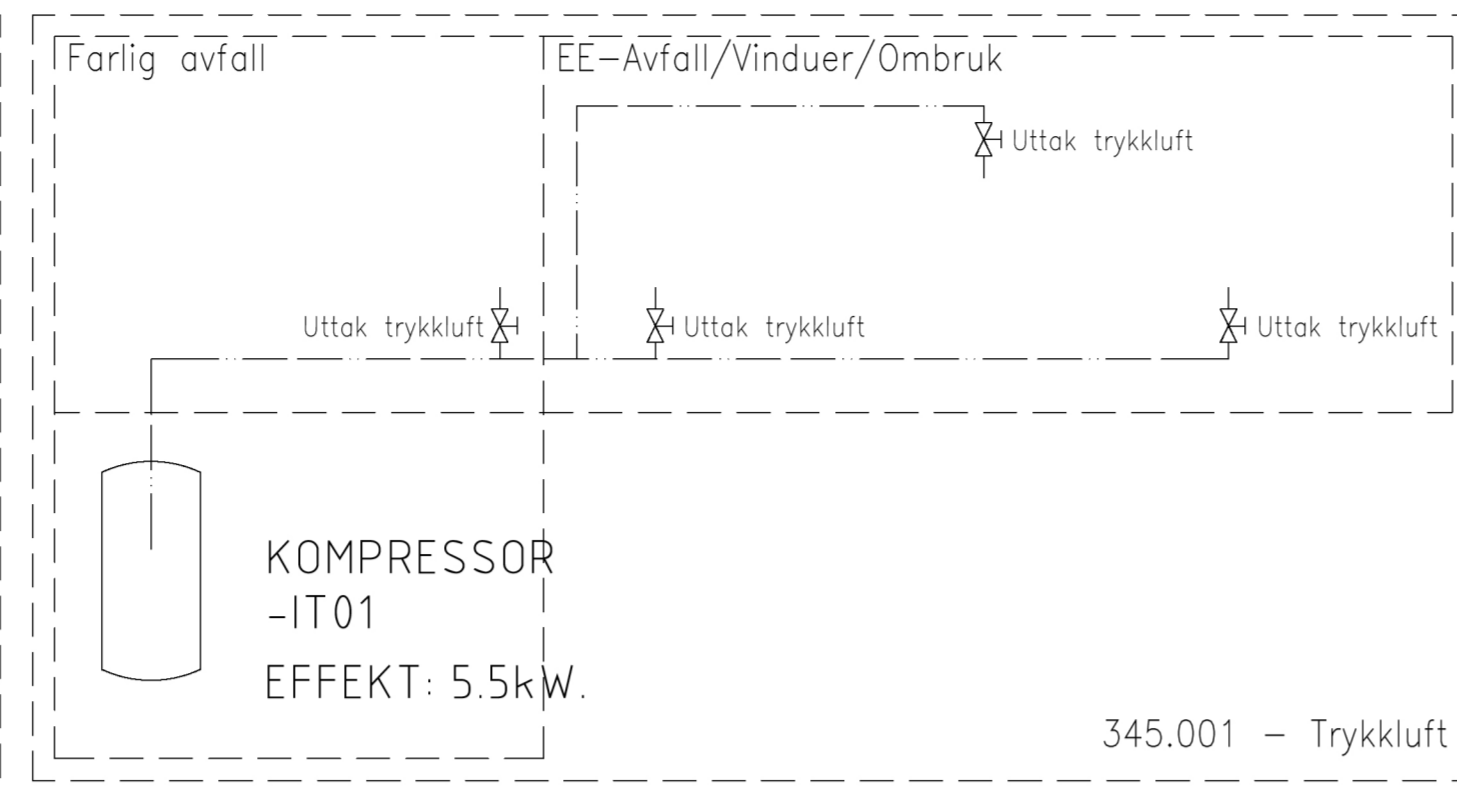
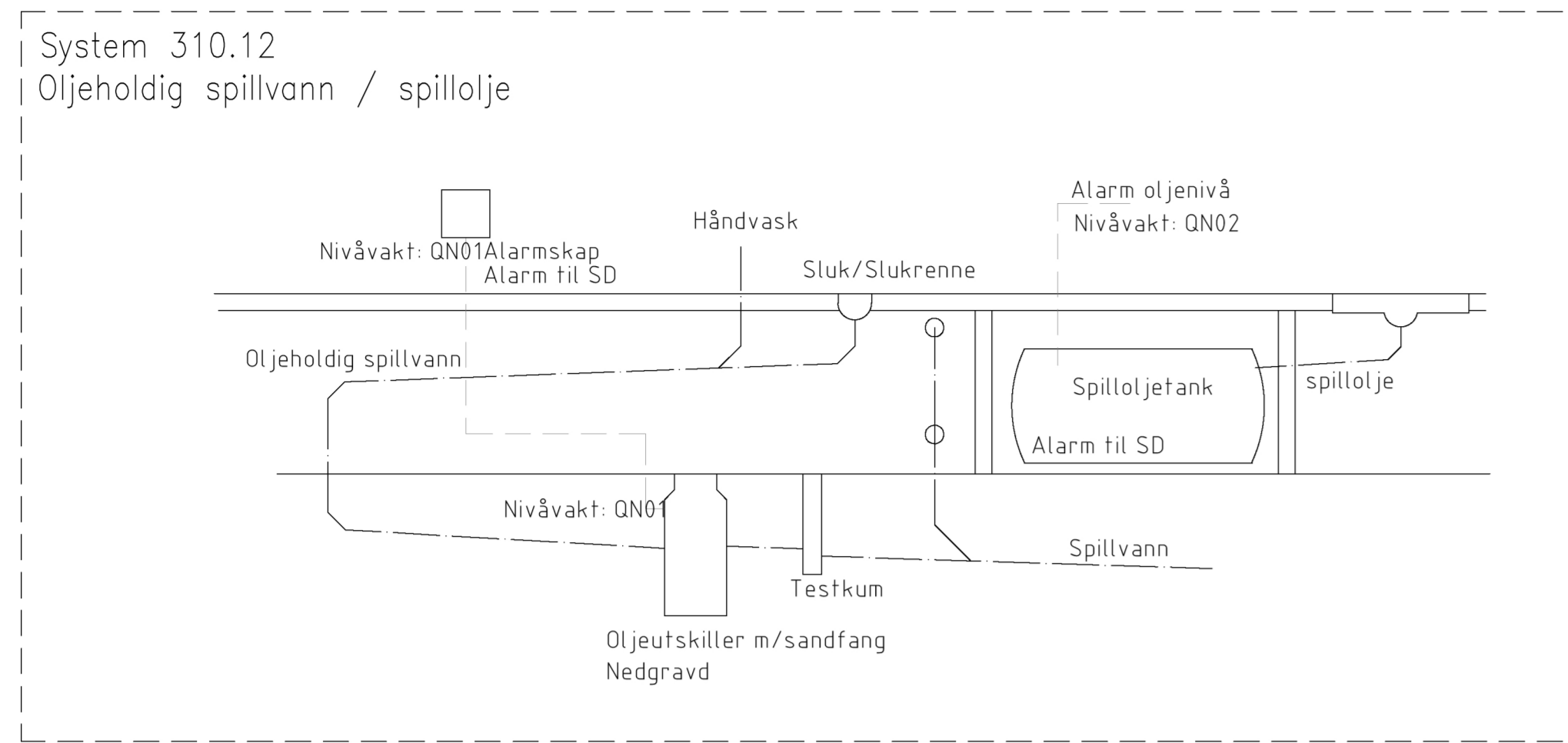

<ul style="list-style-type: none"> Avstengingsventil 2-veisventil, modulerende Trykkavhengig 2-veisventil, Åpav/steng Trykkreduksjonsventil Tilbakeslagsventil Reguleringsventil m/målestak Trykkavhengig ventil Sikkerhetsventil 3-veisventil, modulerende Filter Kondensspalte Vakuumventil Microblefuktkiller Kompensator (CO) Fastpunkt Styring Plugg Blindflens Pumpe Tvillingpumpe 	<ul style="list-style-type: none"> Temperaturmåler (Termometer) Temperaturgiver Termostatt Trykkmåler (Manometer) Trykkgiver Pressostat Mengdemåler Mengdegiver Strømspåk Hastighetsgiver Fukighetsmåler Fukighetsgiver Hygrosstat Entsøggiver Motor, modulerende Motor, av/på Filtervakt CO2-føler Buskommunikasjon Energimåler (fleksibel) Temperaturgiver på tur og retur Energimåler (elektrisk) Ekspansjonskar Kjøil for fast Brensel 	<ul style="list-style-type: none"> Gassfyllt kjø Djøfyllt kjø Elek Akkumulator VVB - varmbrenn oppvarmet VVB el. oppvarmet Varmerestler
--	--	--

Tegning nr. **V-70-0X-30-01-2022-Energianlegg**

TILBUDSTEGNING	TOTALENTPREISE	ED	09.02.23
TILBUDSTEGNING		ED	04.04.22
REV.	TEKST	SIGN.	DATE
		ED	06.09.21
KARMØY KOMMUNE		KONTR.	SAL
P56800 - NY GJENVINNINGSTASJON BORGAREDALEN		DATE	16.02.22
SYSTEMSKJEMA ENERGIANLEGG		PROSJEKT	-
TRYKKLUFT, KJØLING, FORBRUKSVANN OG OLJEHOLDIG SPILLVANN		PROSJEKT	2321
Ferkingsstad og Alsaker		TEGNER	V-70-0X-30-01-2022
RÅDGIVENDE INGENIØRER VVS		REV.	
Karmøysgt 58 - 5522 Haugesund - Tlf 52 70 53 60 - Fax 52 70 53 66			



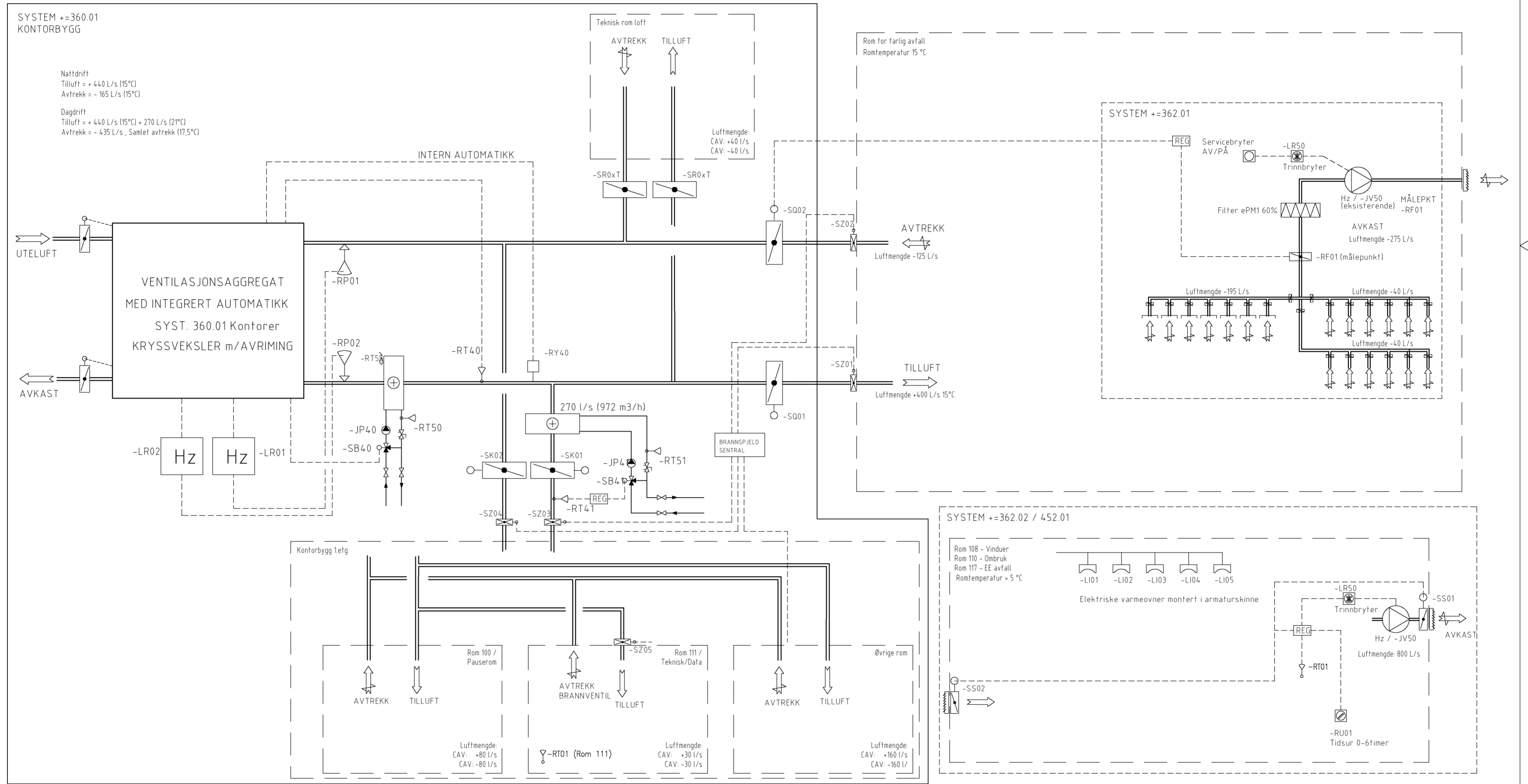

	TILBUDSTEGNING TOTALENTREPRISE	ED	09.02.23
	TILBUDSTEGNING	ED	04.04.22
REV.	TEKST	SIGN.	DATO
	KARMØY KOMMUNE	TEGN.	ED
	P56800 - NY GJENVINNGSSTASJON BORGAREDALEN	KONTR.	SAL
	SYSTEMSKJEMA VENTILASJONSANLEGG 360.01 / 362.01 / 362.02	GODKJ.	ED
		Målestokk:	-
		Prosj.nr	2321
		Tegn. nr	V-70-0X-30-02-2022
		Rev.	

