

PLAN

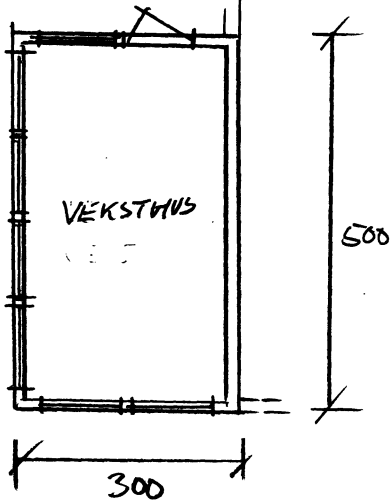

15m² BYA

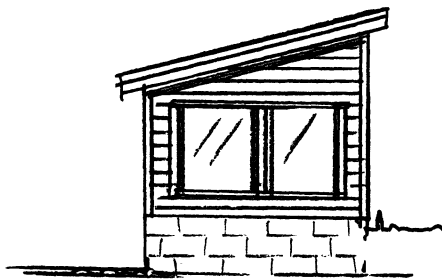
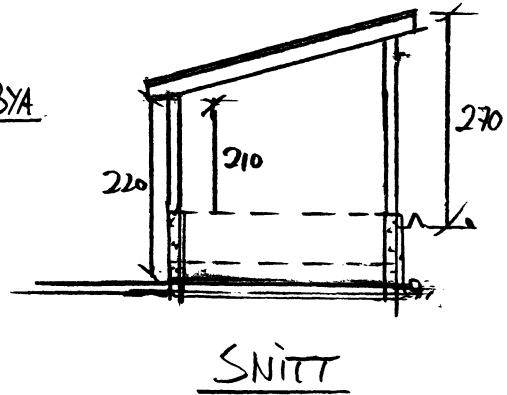

SØR VEST

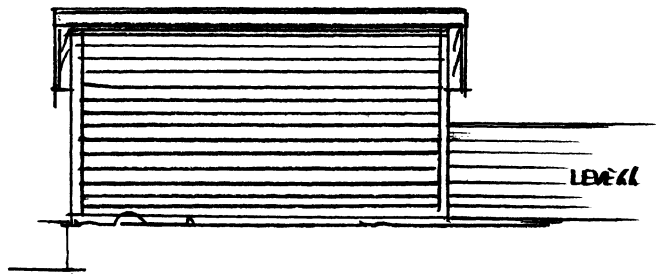

SØR ØST

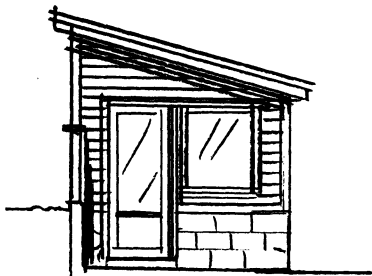

NØRD ØST

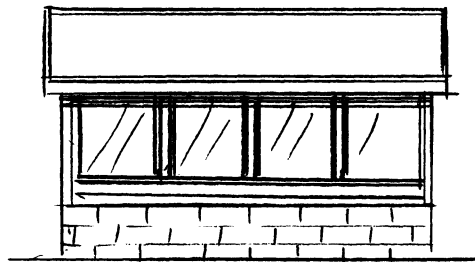

NØRD VEST

Dato	Konst/Tegnet	Godkjent	Målestokk	Gnr. 63
26.01.23	<i>[Signature]</i>		1:100	Bnr. 187
HELGE TORGERSEN				VEKSTHUS/ HAGESTUE 15m ²
HOGÅSV. 55		4250 KOPPERVIK		
Tegn. nr. 1	PLAN/SNITT/FAS			

PLAN

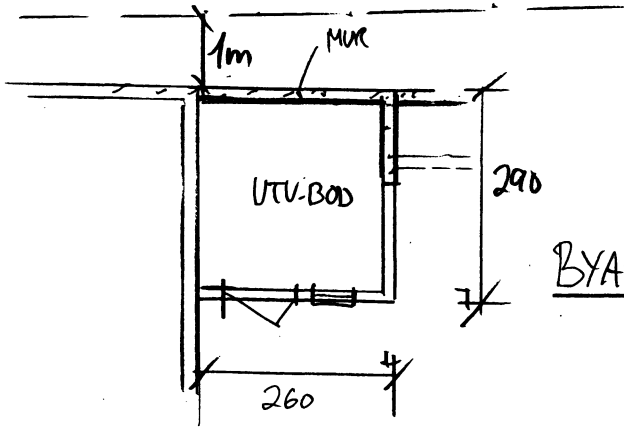

$BYA = 7,5m^2$

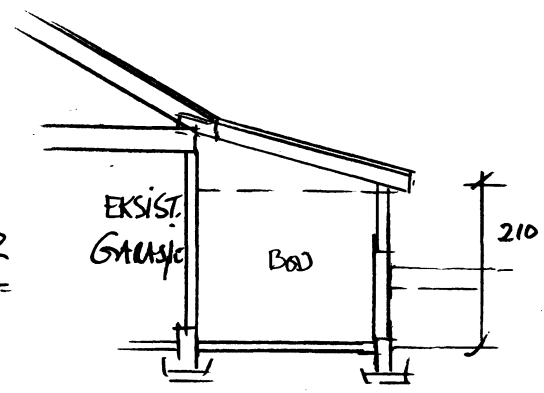

SNITT

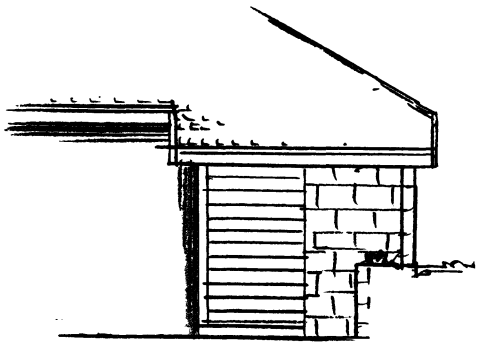

SØR ØST

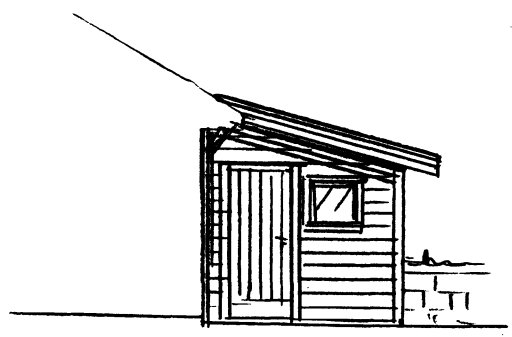

SØR VEST

(IKKE SYNLIG)

NORD VEST

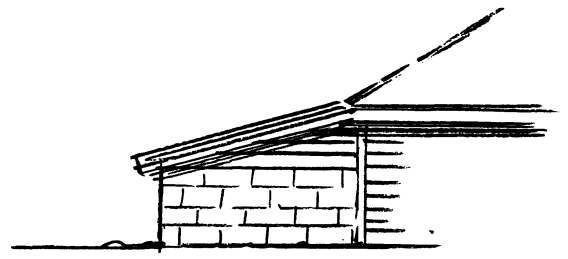

NØRD ØST

Dato	Konst/Tegnet	Godkjent	Målestokk	Gnr. 63
	<i>[Signature]</i>		1:100	Bnr. 187
HELGE TONGERSEN				UTV. BOD v/ GARASJE 7,5m ² BYA
HØGÅSV. 55 4250 KOPERVIK				
Tegn. nr. 2		PLAN / SNITT / FAS		

PLAN

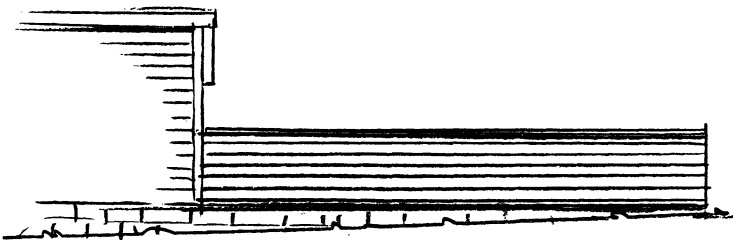
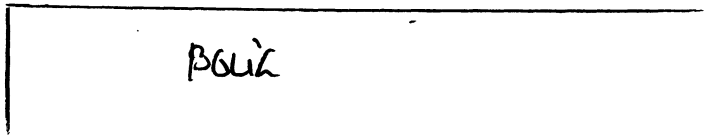
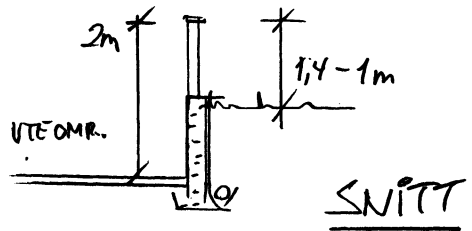
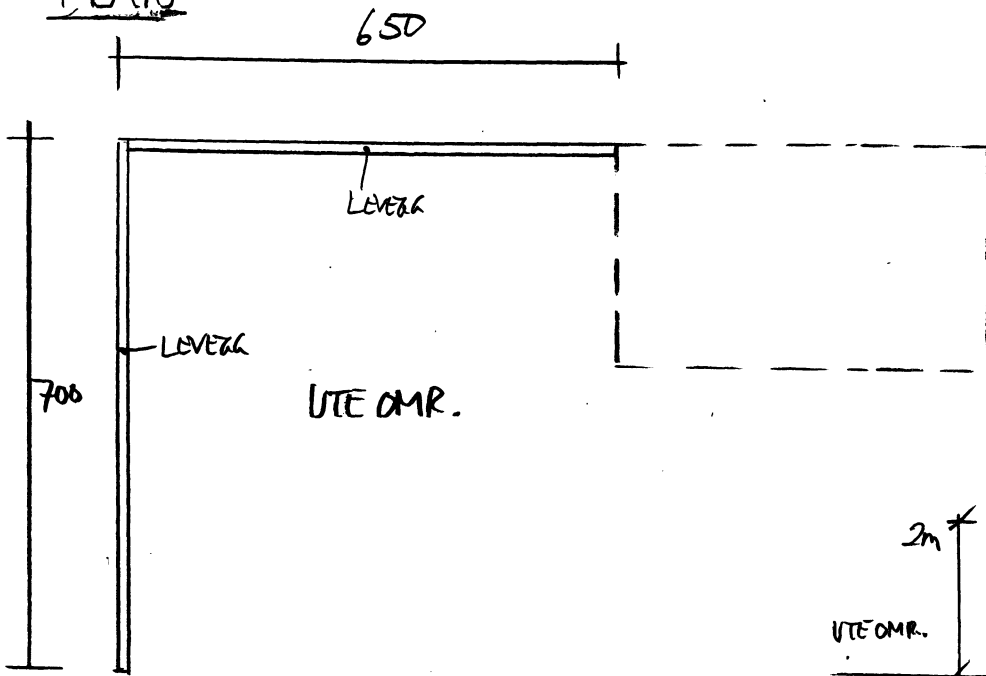

SØR ØST

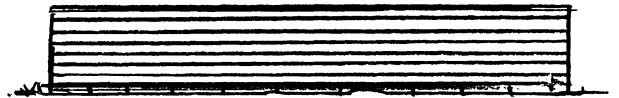

NØRD ØST

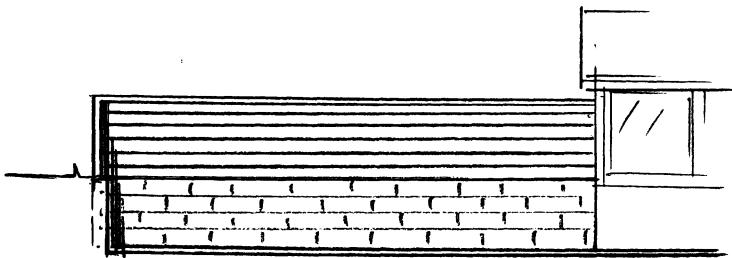

NØRD VEST

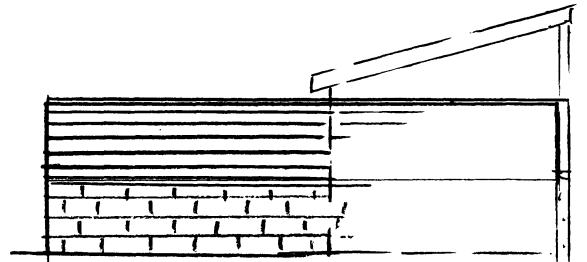

SØR VEST

Dato	Konst/Tegnet	Godkjent	Målestokk	Gnr:	63
26.01.23			1:100	Bnr:	187
HELGE TORGENSEN				LEVEGG / UTE OMR.	
HØRÅSV. 55 4250 KOPPEVIK					
Tegn. nr.	3	PLAN / SNITT / FAS			