

PLAN

LEVEKK

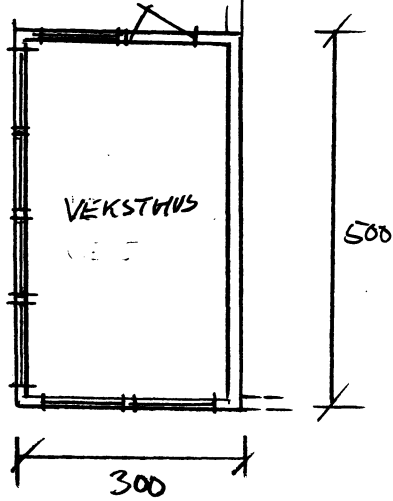

15m² BYA

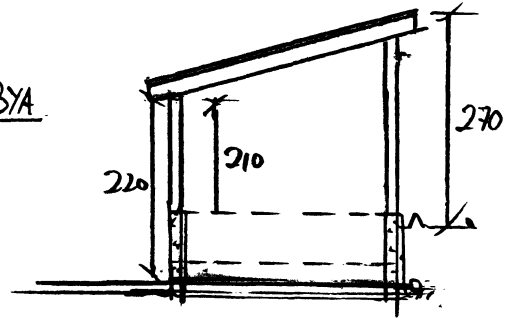

SNITT

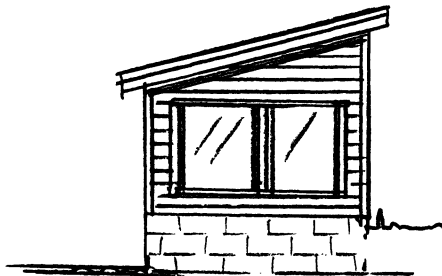

SØR VEST

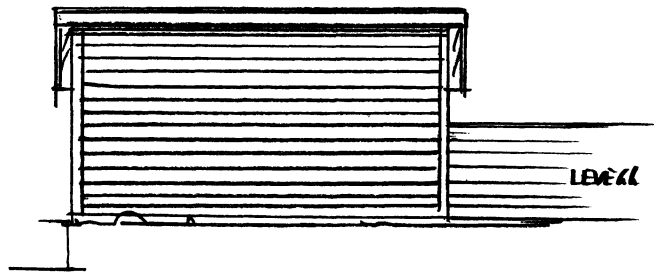

SØR ØST

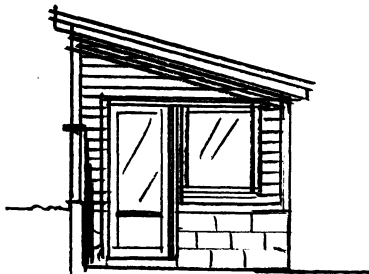

NØRD ØST



NØRD VEST

Dato	Konst/Tegnet	Godkjent	Målestokk	Gnr: 63
26.01.23			1:100	Bnr: 187
HELGE TORGERSEN				VEKSTHUS/ HAGESTUE 15m ²
HEGÅSV. 55 4250 KJØPERVIK				
Tegn. nr. 1		PLAN/SNITT/FAS		

UTV:BAD v/BAKSTJE 7,5 m ² BYA		PLAN / SNITT / AVS		Tegn. nr. 2	
		HELE TILGERSJEL		HØRSV. 55 VEST KØRERIK	
Gnr: 63 Bnr: 187		Målestokk 1:100		Dato	
		Godkjent		Konst/Tegnet	

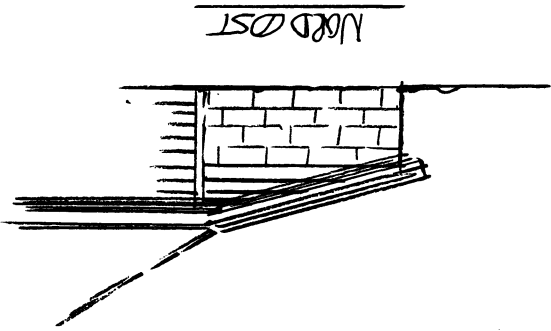

NORD VEST
(IKKE SPULIS)

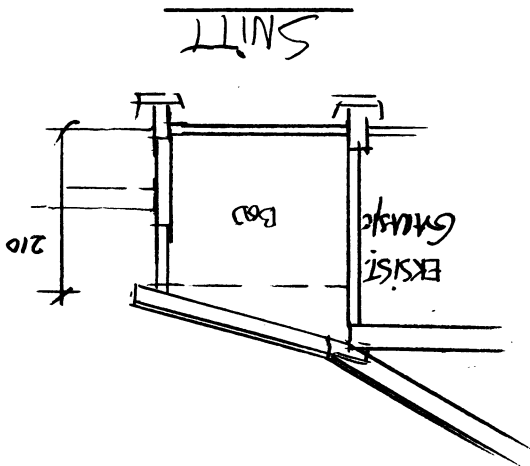
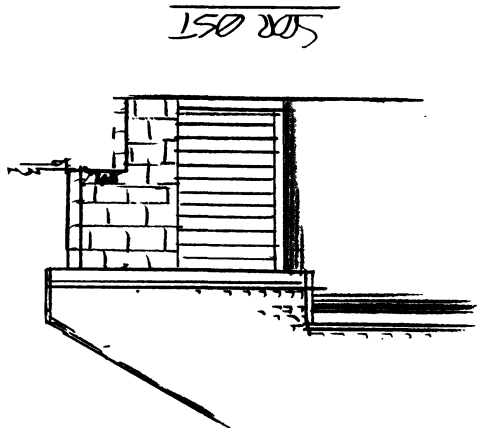
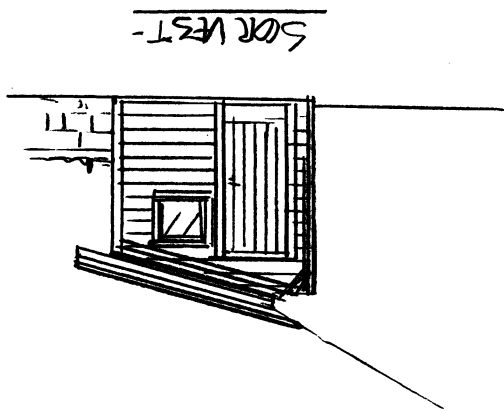

BYA = 7,5 m²

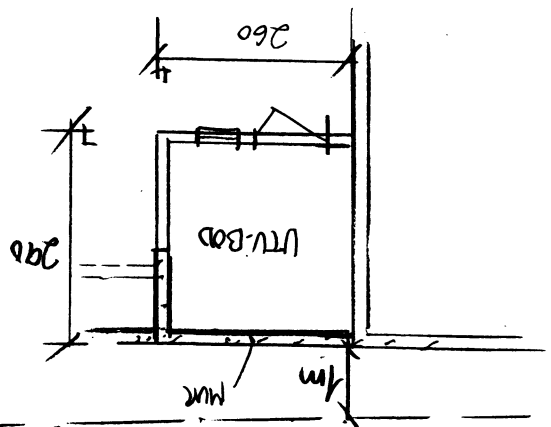

PLAN

PLAN

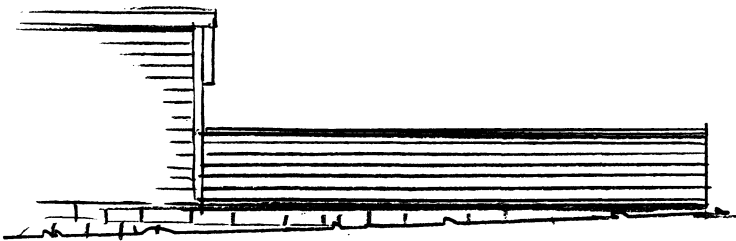
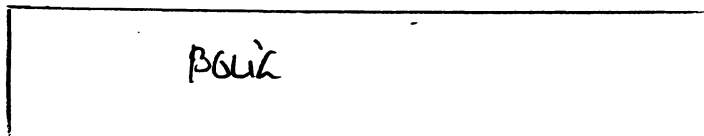
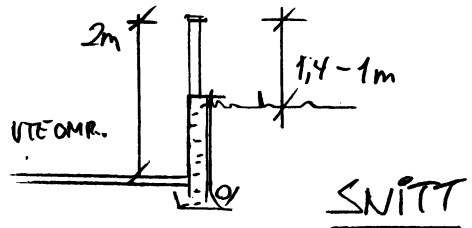
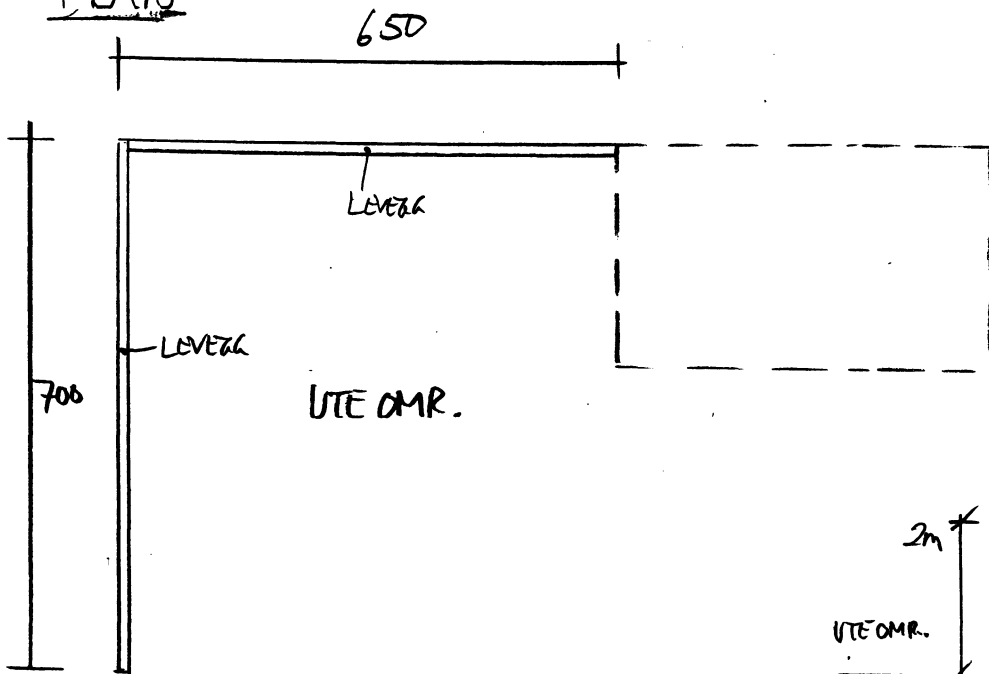

SØR ØST



NORD ØST

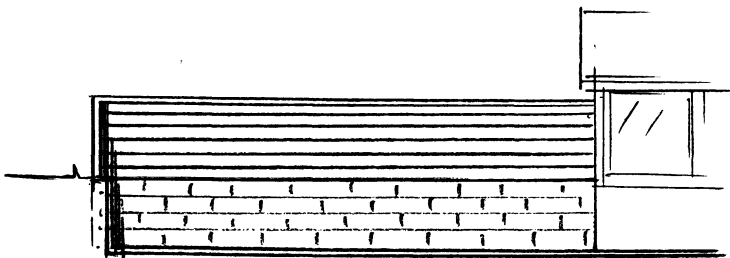

NORD VEST

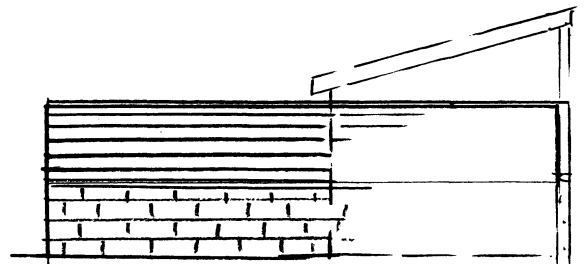

SØR VEST

Dato	Konst/Tegnet	Godkjent	Målestokk	Gnr.
26.01.23			1:100	63
HELGE TORGERSEN				Bnr.
HOGÅSV. 55 4250 KOPPEVIK				187
Tegn. nr.	PLAN/SNITT/FAS.			LEVEGG / UTE OMR.
3				