

3 3D Oljeutskiller
Allerede montert

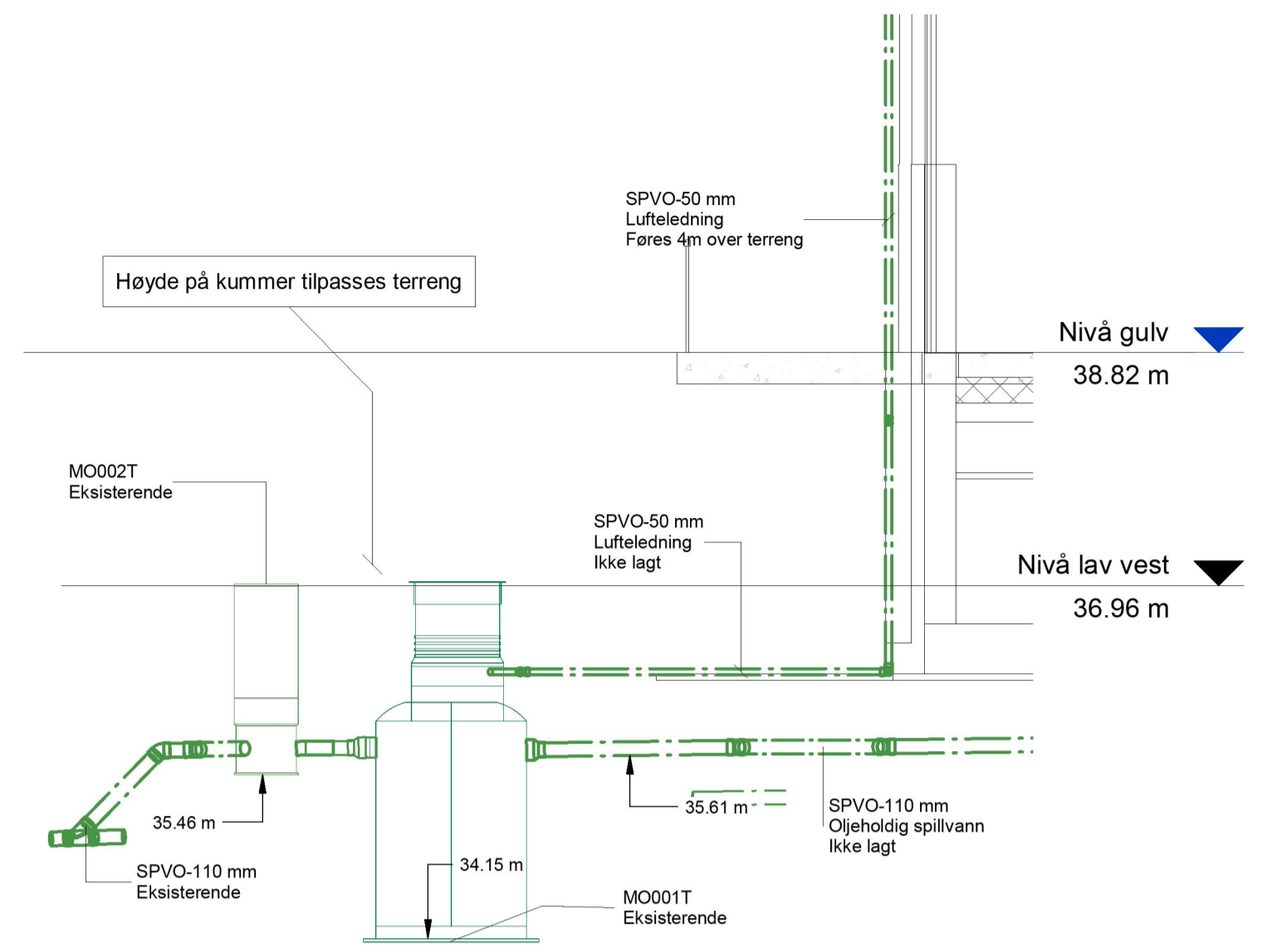

2 Snitt oljeutskiller
1 : 50

Tegn. nr V-10-UH-30-00-2021		Rev. B
TEGNFORKLARING		
Drens	---	
Spillvann	---	
Overvann	---	
Radonsikring	---	
Vannledning	---	
Overvannsrenne	---	
Taknedløp 6-13 avsluttes 2,5m over bakkenivå. Taknedløp 1-5-13 avsluttes ved taksluk		
Rev	Revideringen gjelder	Tegn. Kontr. Dato.
KARMØY KOMMUNE		ED DATO
P56800 - NY GJENVINNINGSSSTASJON BORGAREDALEN		KONTR. SAL DATO
Utendørsplan VVS		16.11.22
Målestokk: As indicated		
Status: TILBUDSTEGNING		
Prosj nr: 2321		Tegn. nr: V-10-UH-30-00-2021
Rev. B		



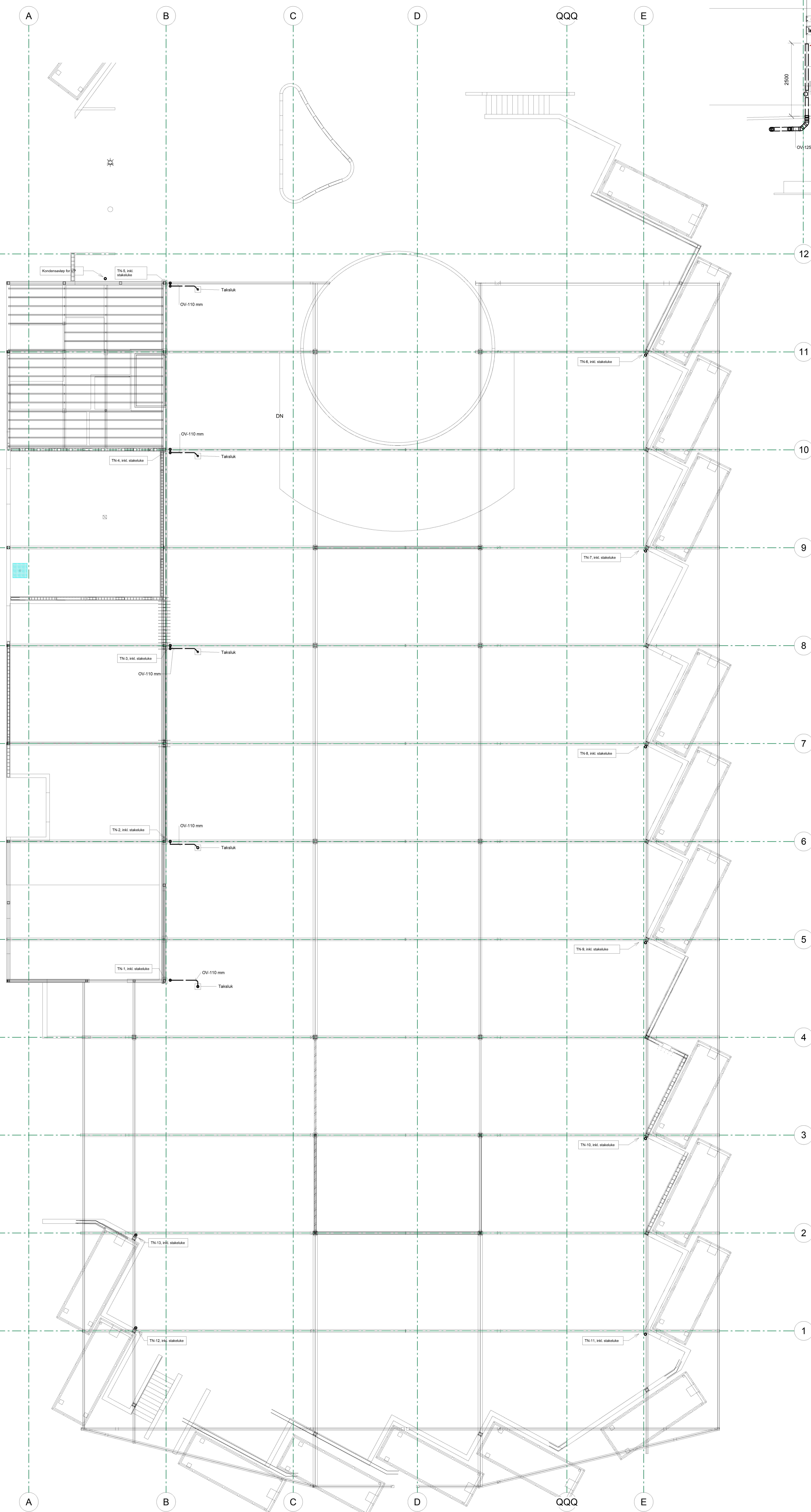

1 Plan under yttertak - Utskrift
1 : 100

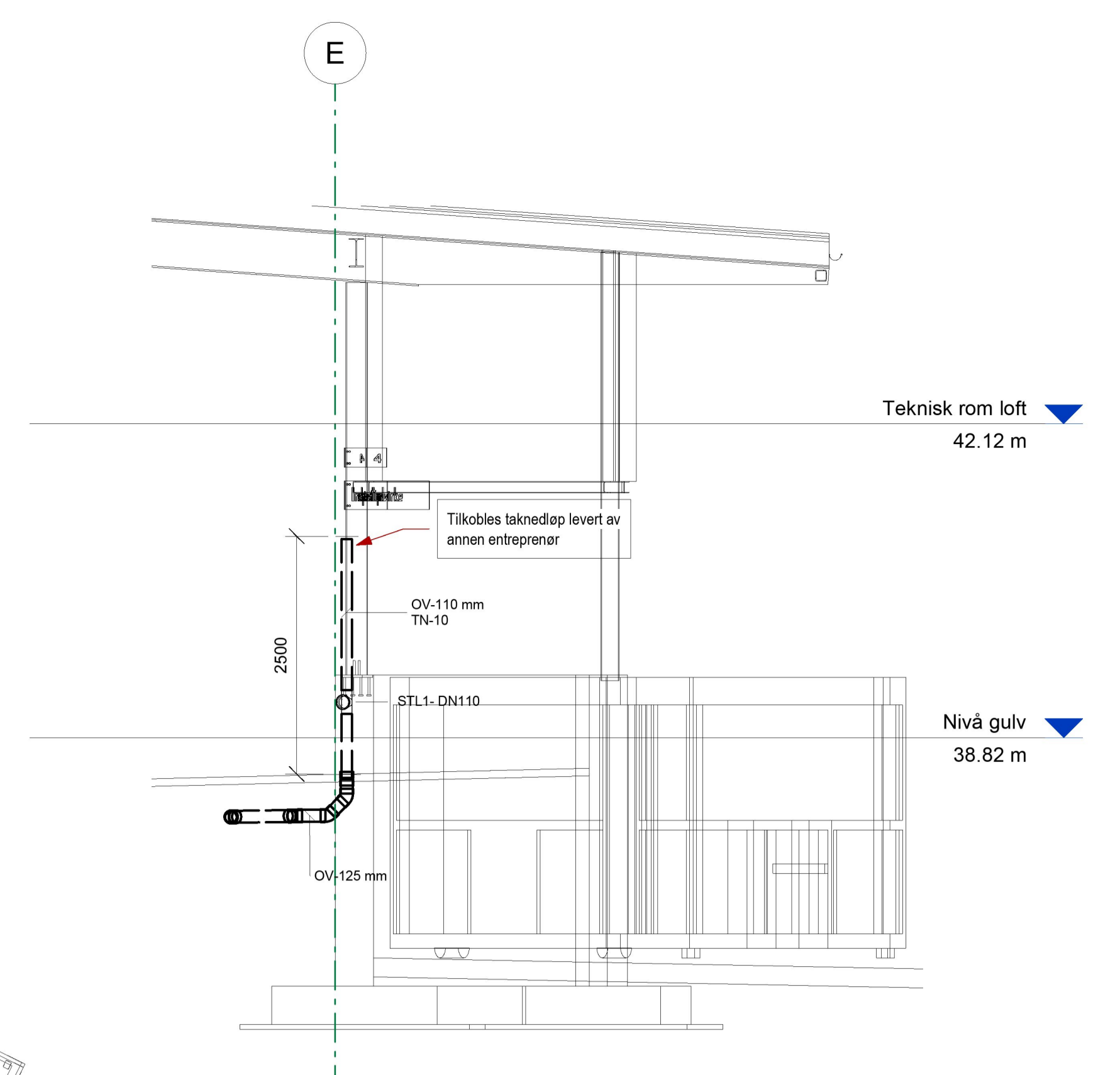

2 Prinsipp taknedløp
1 : 50

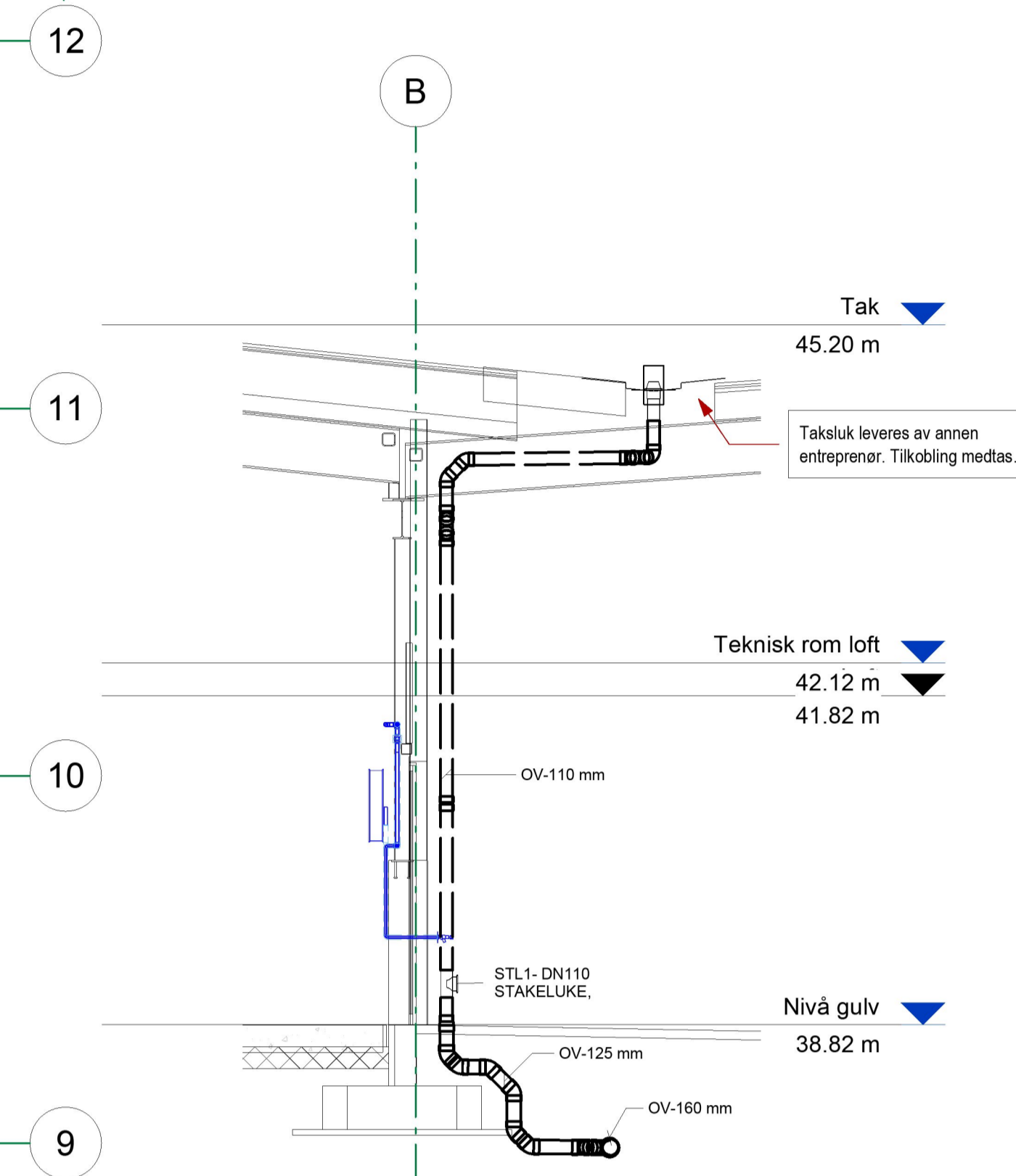

3 Prinsipp taks luk
1 : 50

TEGNFORKLARING		Fig. nr	Rev
Drens	---	V-10-UH-31-01-2022	
Spillvann	---		
Overvann	---		
Radonsikring	---		
Vannledning	---		
Overvannsrenne	---		

Taknedløp 6-13 avsluttes 2.5m over bakkenivå.
Taknedløp 1-5-13 avsluttes ved taks luk

Rev	Rev	Rev	Rev	Rev	Rev
Tilbudstegning	Tilbudstegning	Tilbudstegning	Tilbudstegning	Tilbudstegning	Tilbudstegning
ED	SAL	ED	SAL	ED	SAL
09.02.23	04.04.22	09.02.23	04.04.22	09.02.23	04.04.22
KARMØY KOMMUNE			KONTRE		
P56800 - NY GJENVINNSSTASJON BORGAREDALEN			SAL		
Overvann fra sedumtak			14.03.22		
As indicated			TILBUDSTEGNING		
Føringsstad og Alsaker			2321		
Karmøy 150 - 5522 Høgland - TR 52 70 51 00			V-10-UH-31-01-2022		



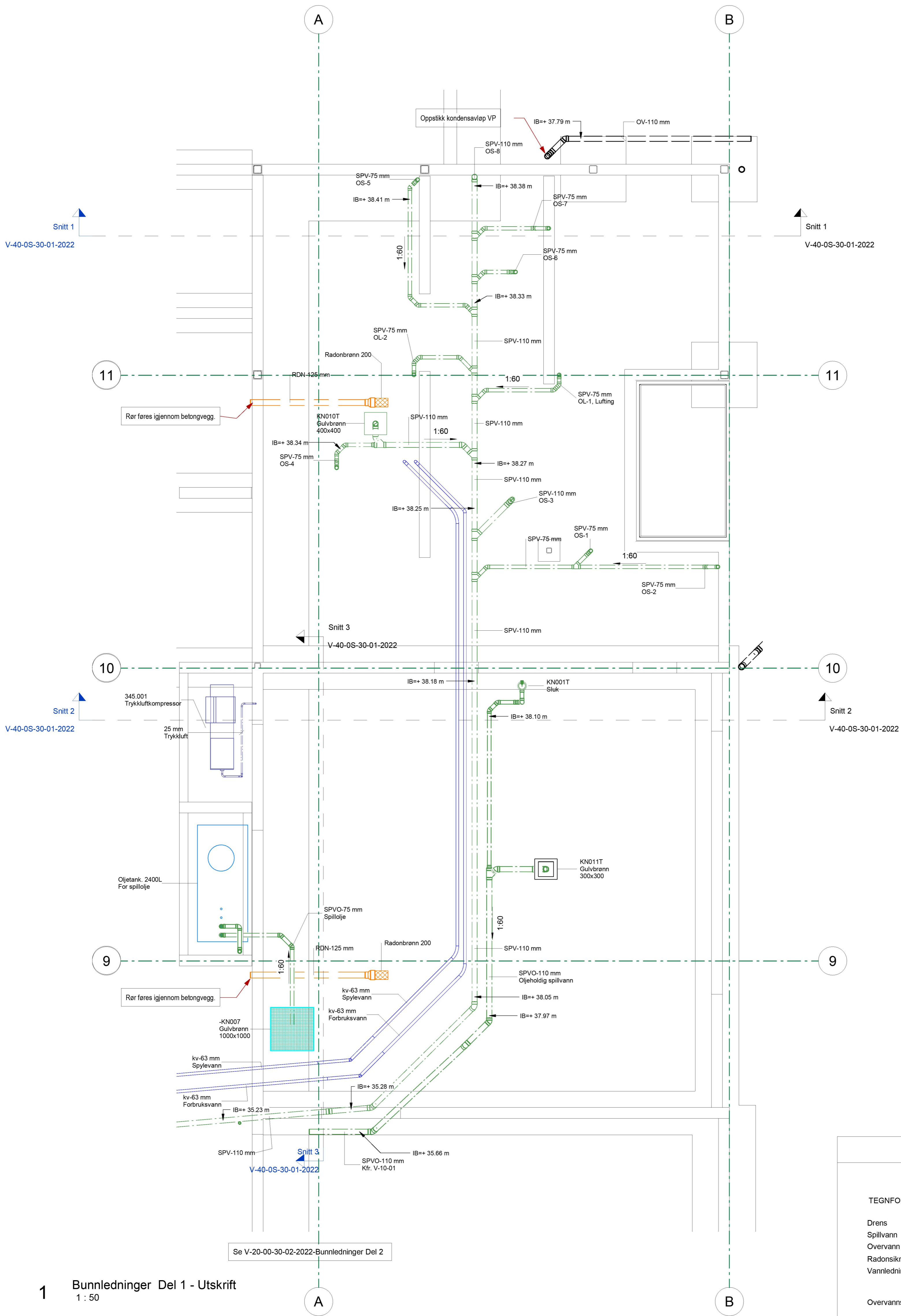







1 Bunnledninger Del 1 - Utskrift
1:50

Rev	Tegn. nr	Rev.
	V-20-00-30-01-2022	

TEGNFORKLARING

Drens	
Spillvann	
Overvann	
Radonsikring	
Vannledning	
Overvannsrenne	

Tilbudstegning Totalentreprise	ED	SAL	09.02.23
Tilbudstegning Byggetrinn HEB	ED	SAL	04.04.22
Rev	Tegn.	Kontr.	Dato.
KARMØY KOMMUNE		ED	DATO
P56800 - NY GJENVININGSSTASJON BORGAREDALEN		KONTR	SAL
Bunnledninger Del 1		DATO	16.02.22
Målestokk:		As indicated	
Status:		TILBUDSTEGNING	
Prosj nr		2321	
Tegn. nr	Rev.		
V-20-00-30-01-2022			



Ferkingstad og Alsaker
RÅDGIVENDE INGENIØRER VVS
Karmsundgt. 159 - 5522 Haugesund - Tlf 52 70 53 80



FORBILDE (564641)

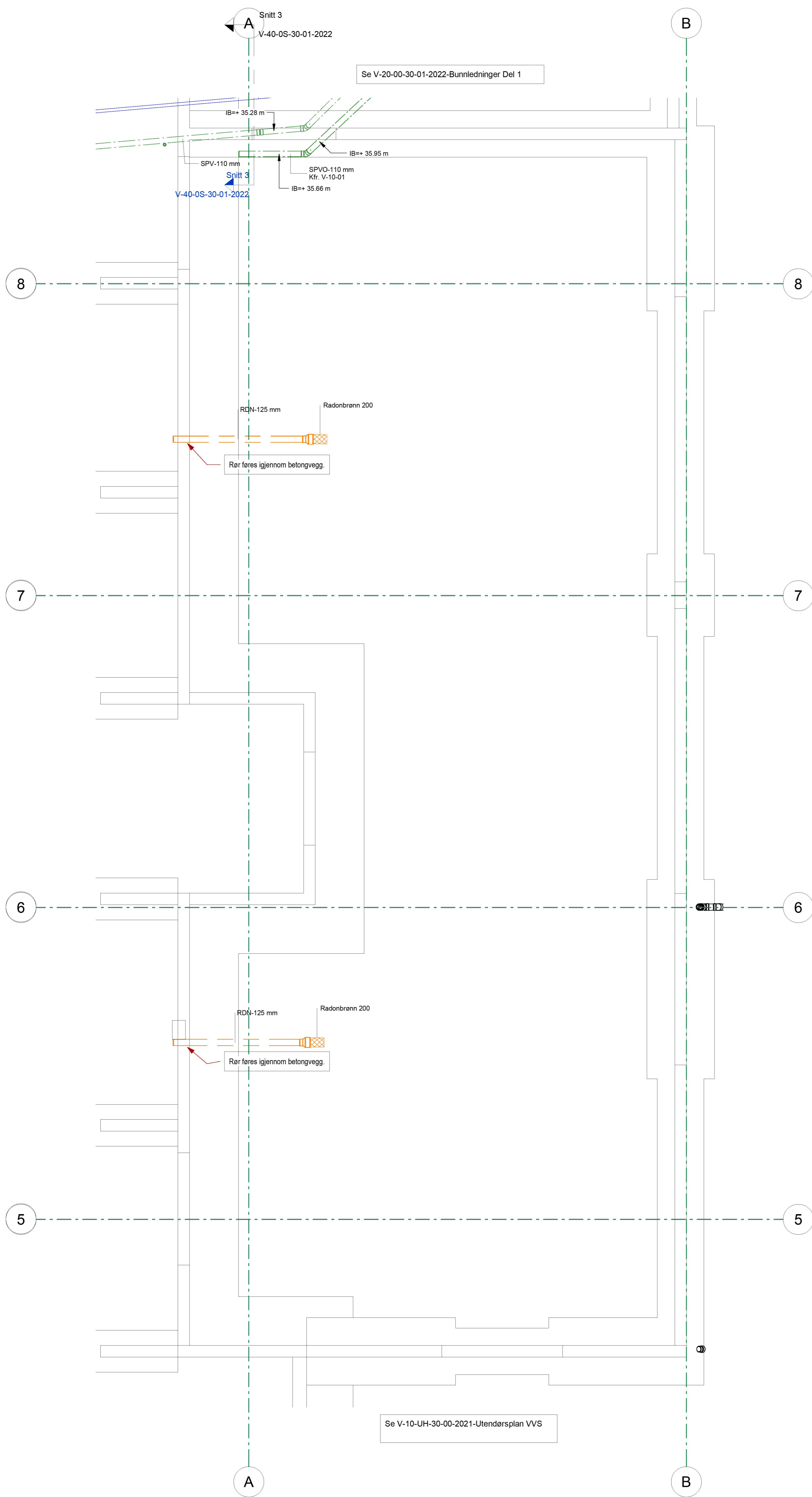

1 Bunnledninger Del 2 - Utskrift
1 : 50

Tegn. nr V-20-00-30-02-2022		Rev.		
TEGNFORKLARING				
Drens				
Spillvann				
Overvann				
Radonsikring				
Vannledning				
Overvannssrenne				
Rev	Tilbudstegning Totalentreprise	ED	SAL	09.02.23
	Tilbudstegning Byggetrinn HEB	ED	SAL	04.04.22
	Revideringen gjelder	Tegn.	Kontr.	Dato.
KARMØY KOMMUNE		TEGN	ED	DATO
P56800 - NY GJENVININGSSTASJON BORGAREDALEN		KONTR	SAL	DATO
Bunnledninger Del 2		Målestokk:	As indicated	
		Status:	TILBUDSTEGNING	
		Prosj.nr	2321	
		Tegn. nr	V-20-00-30-02-2022	
		Rev.		



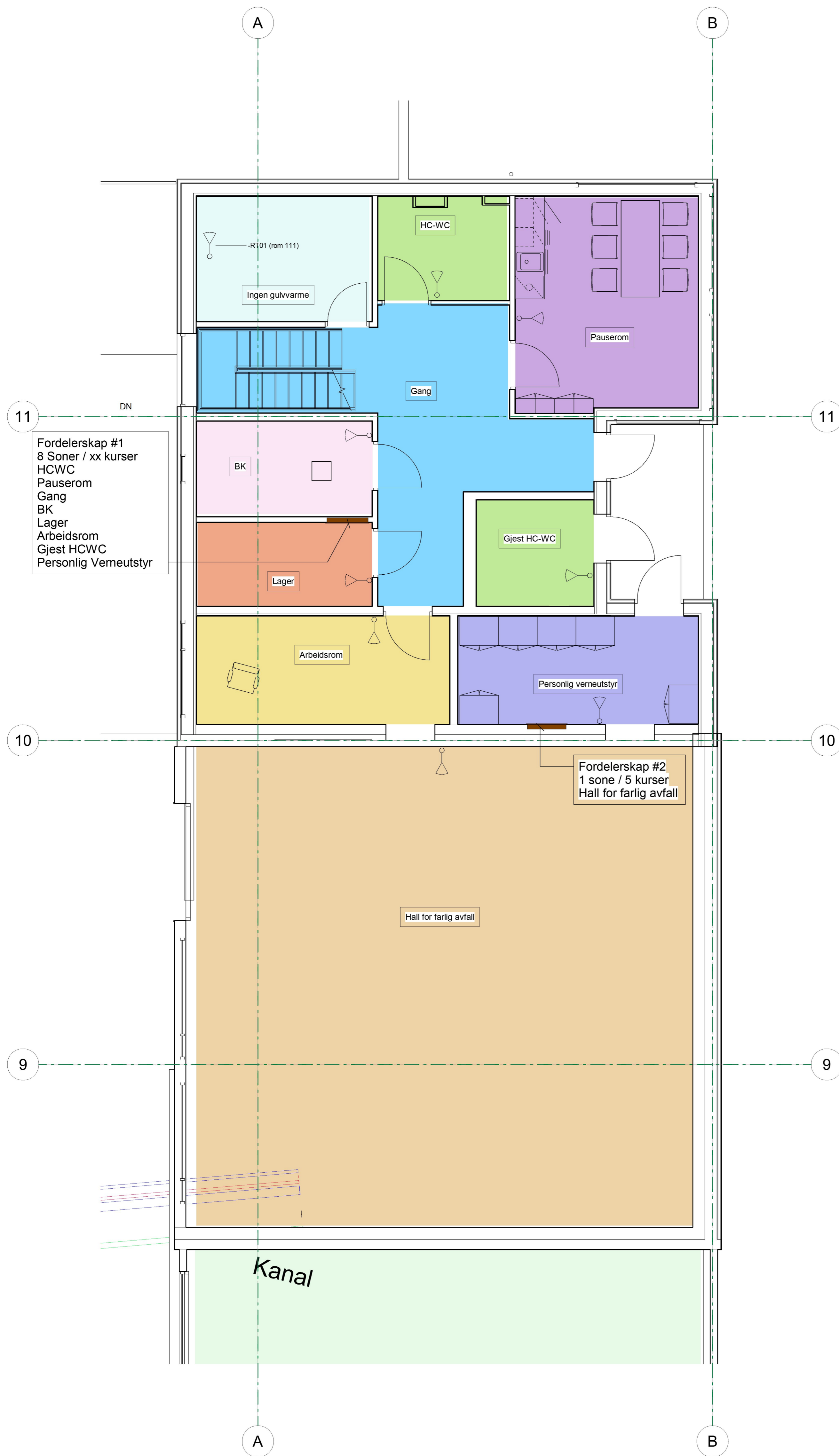

- Fordelerskap #1
- 8 Soner / xx kurser
- HCWC
- Pauserom
- Gang
- BK
- Lager
- Arbeidsrom
- Gjest HCWC
- Personlig Verneutstyr

Rev	Tilbudstegning Byggetrinn HEB	Tegn.	ED	SAL	09.02.23
		Kontr.	SAL		04.04.22

Rev	Tilbudstegning Totalentreprise	Tegn.	ED	SAL	09.02.23
		Kontr.	SAL		04.04.22
KARMØY KOMMUNE		Tegn.	ED	DATO	
P56800 - NY GJENVININGSSTASJON BORGAREDALEN		Kontr.	SAL	DATO	16.02.22
Gulvvarme Del 1		Målestokk:	1 : 50		
		Status:	TILBUDSTEGNING		
		Prosj.nr	2321		
		Tegn.nr	V-20-00-32-01-2022		



Ferkingstad og Alsaker
RÅDGIVENDE INGENIØRER VVS
Karmsundgt. 159 - 5522 Haugesund - Tlf 52 70 53 80



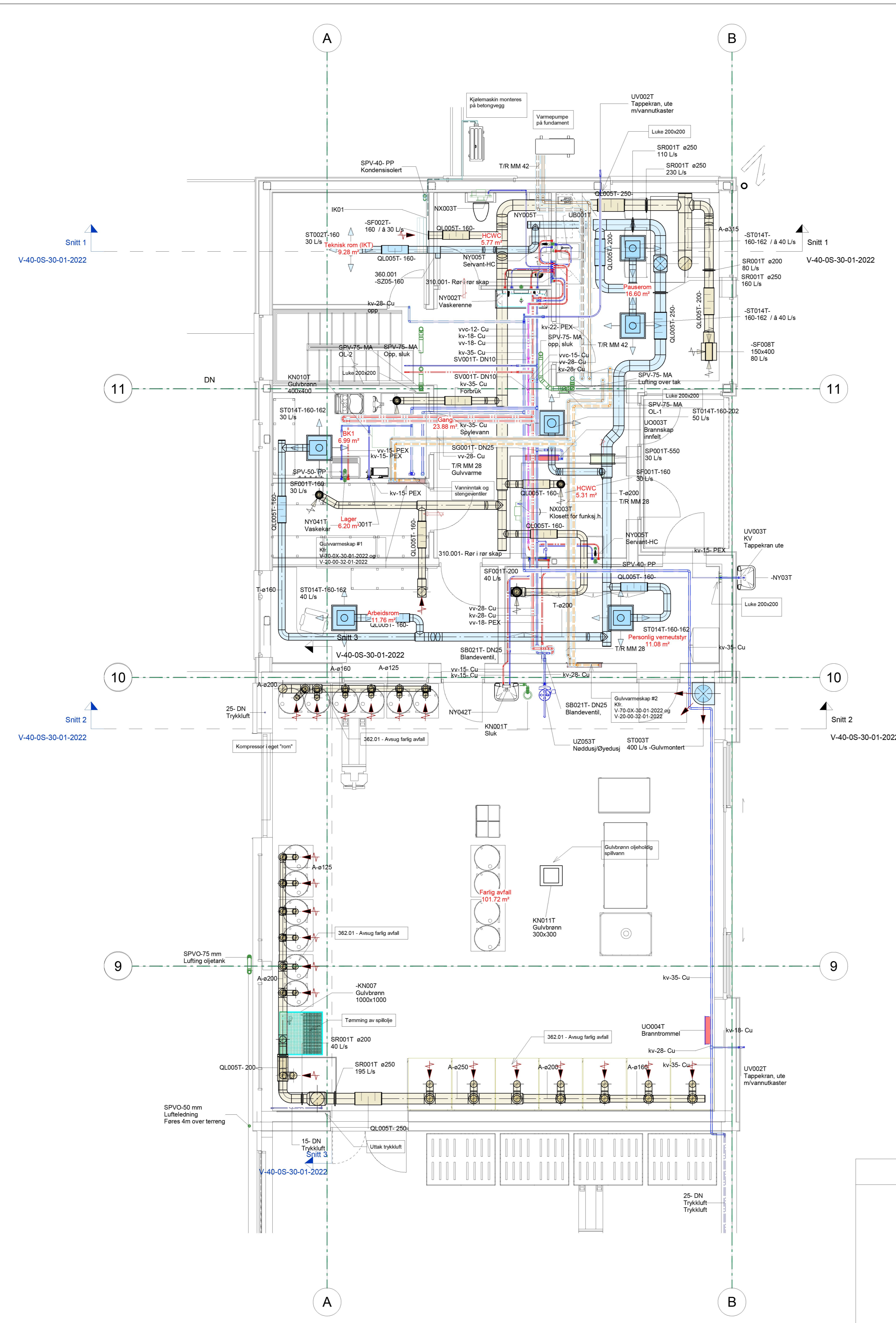

Tegn. nr	V-20-01-30-01-2022	Rev.	
Rev			
Tilbudstegning Totalentreprise	ED	SAL	09.02.23
Tilbudstegning Byggetrinn HEB	ED	SAL	04.04.22
KONTROL	ED	DATO	
KONTROL	SAL	DATO	16.02.22
Målestokk:	1 : 50		
Status:	TILBUDSTEGNING		
Prosj nr	2321		
Tegn. nr	V-20-01-30-01-2022	Rev.	

Tilbudstegning Totalentreprise		ED	SAL	09.02.23
Tilbudstegning Byggetrinn HEB		ED	SAL	04.04.22
Rev	Revideringen gjelder	Tegn.	Kontr.	Dato.
KARMØY KOMMUNE		ED	DATO	
P56800 - NY GJENVINNINGSTASJON BORGAREDALEN		KONTR	SAL	DATO
Plan 1.etg Del 1		Målestokk:	1 : 50	
		Status:	TILBUDSTEGNING	
		Prosj nr	2321	
		Tegn. nr	V-20-01-30-01-2022	Rev.



Ferkingstad og Alsaker
RÅDGIVENDE INGENIØRER VVS
Karmsundgt. 159 - 5522 Haugesund - Tlf 52 70 53 80



FCB/MT: (254641)

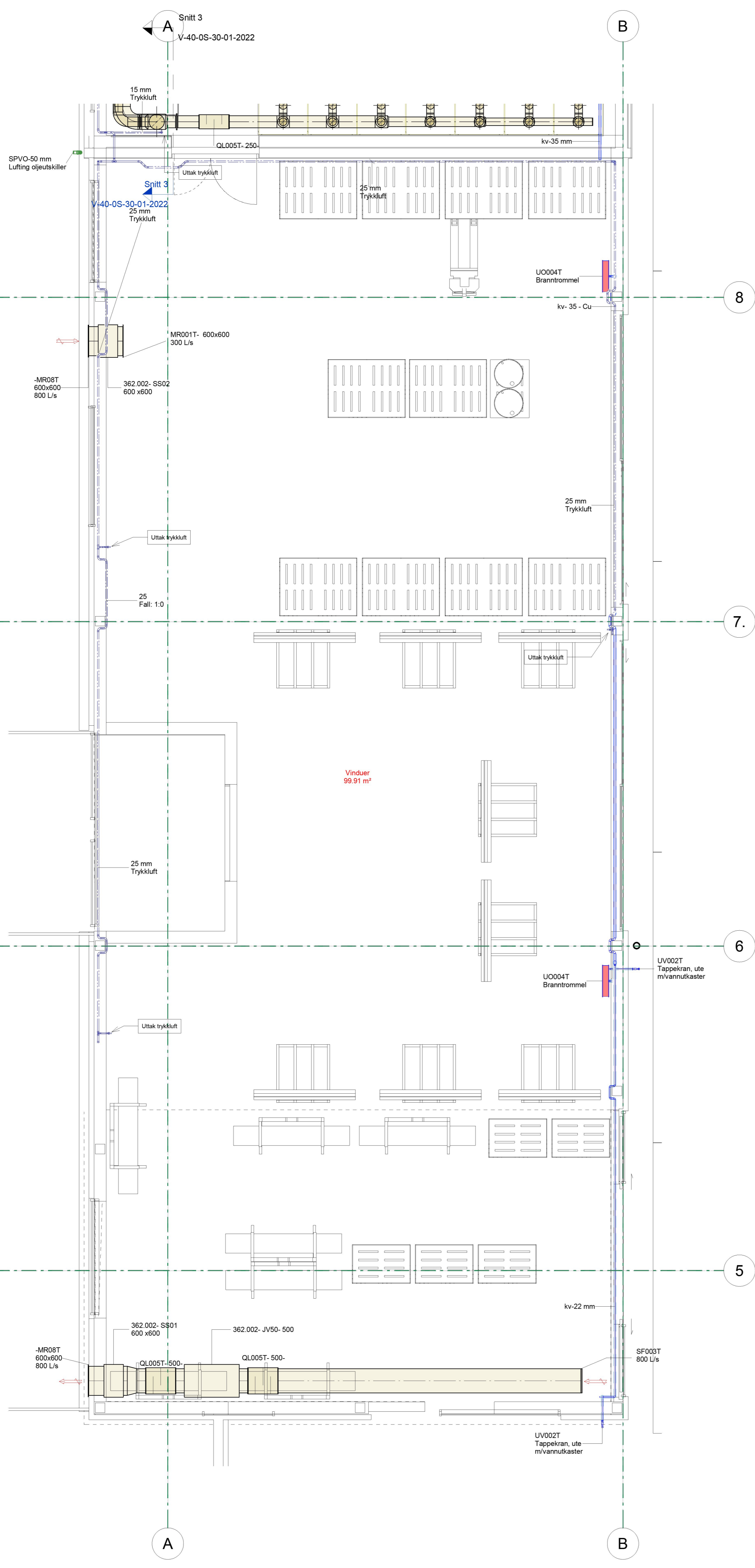

Rev	Tegn. nr	Rev.
	V-20-01-30-02-2022	

Tilbudstegning Totalentreprise		ED	SAL	09.02.23
Tilbudstegning Byggetrinn HEB		ED	SAL	04.04.22
Rev		Tegn.	Kontr.	Dato.
KARMØY KOMMUNE		ED	DATO	
P56800 - NY GJENVININGSSTASJON BORGAREDALEN		KONTR.	SAL	DATO
Plan 1.etg Del 2		16.02.22		
Målestokk:		1 : 50		
Status:		TILBUDSTEGNING		
Prosj nr		2321		
Tegn. nr		V-20-01-30-02-2022		
Rev.				



KARMØY KOMMUNE
 RÅDGIVENDE INGENIØRER VVS
 Karmundgt. 159 - 5522 Haugesund - Tlf 52 70 53 80



Ferkingstad og Alsaker
 RÅDGIVENDE INGENIØRER VVS
 Karmundgt. 159 - 5522 Haugesund - Tlf 52 70 53 80

F0304T (25x64x1)

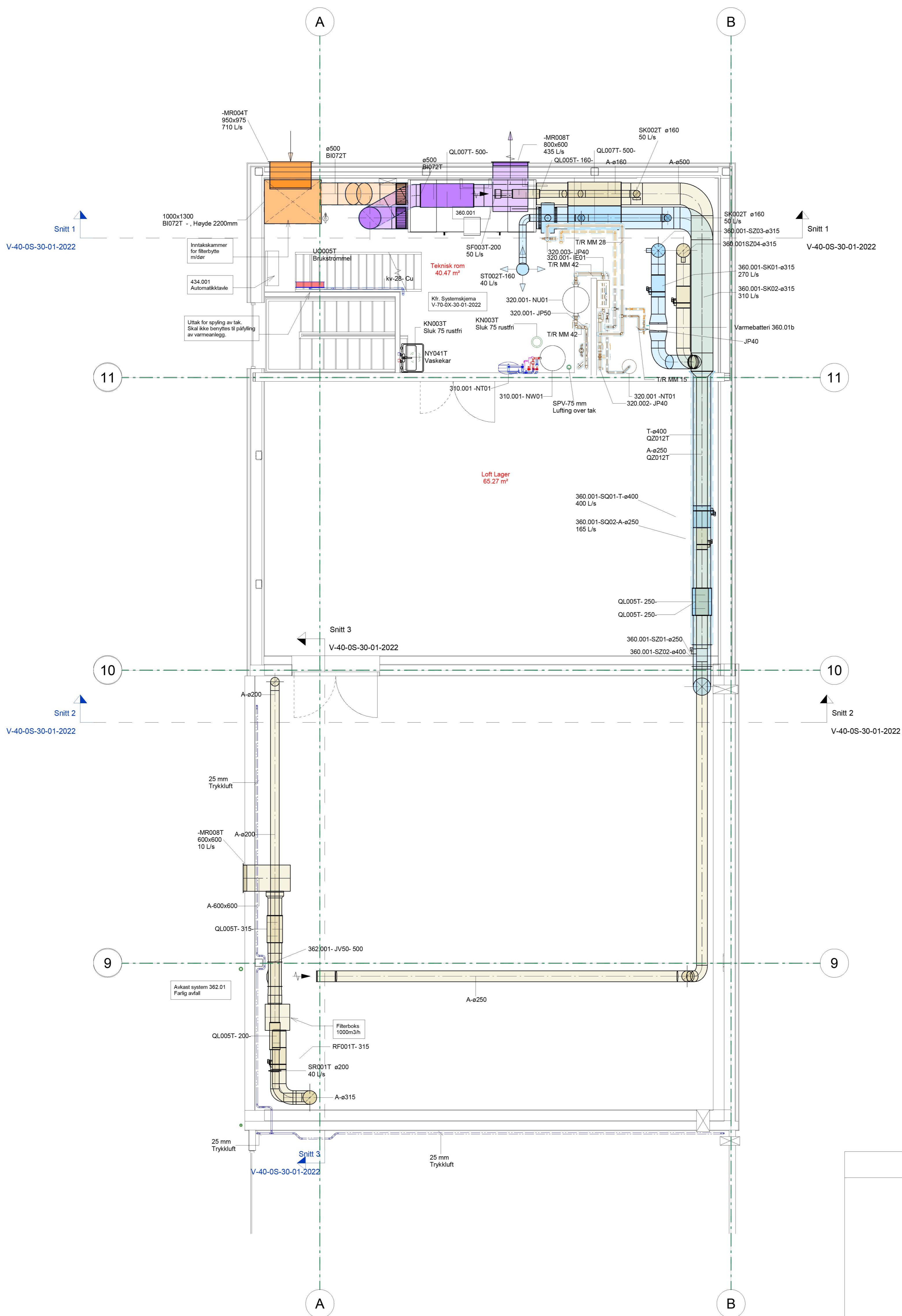

Tegn. nr	V-20-02-30-01-2022	Rev.	
----------	--------------------	------	--

Tilbudstegning Totalentreprise	ED	SAL	09.02.23
Tilbudstegning Byggetrinn HEB	ED	SAL	04.04.22
Rev	TEGN	KONTR	DATO
	ED	SAL	16.02.22
Målestokk:	1 : 50		
Status:	TILBUDSTEGNING		
Prosj nr	2321		
Tegn. nr	V-20-02-30-01-2022	Rev.	



Ferkingstad og Alsaker
RÅDGIVENDE INGENIØRER VVS
Karmsundgt. 159 - 5522 Haugesund - Tlf 52 70 53 80



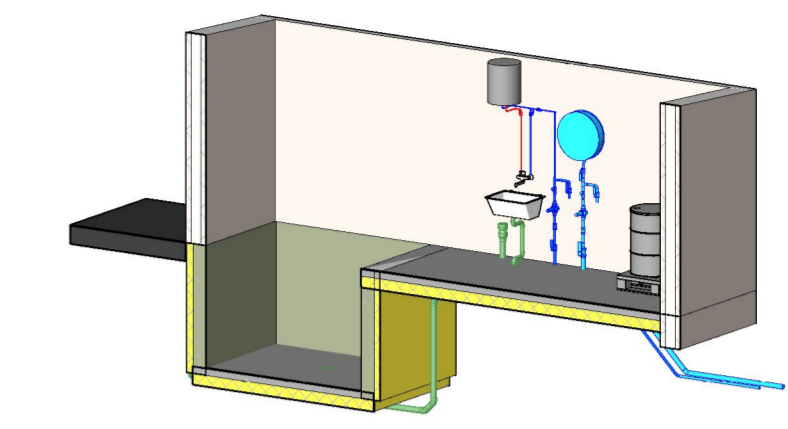
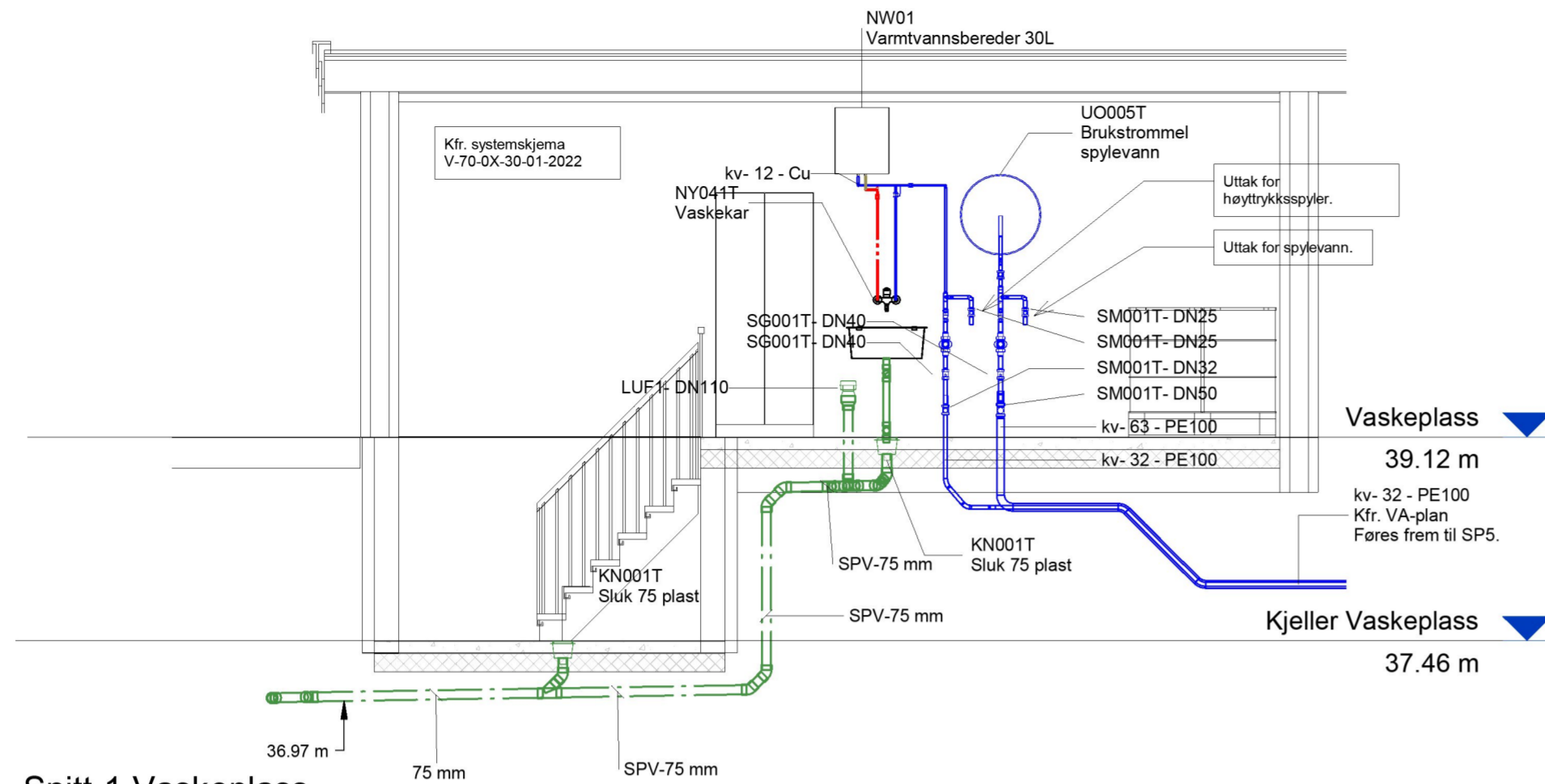

3 3D Vaskeclass

4 Snitt-1 Vaskeclass
1 : 50

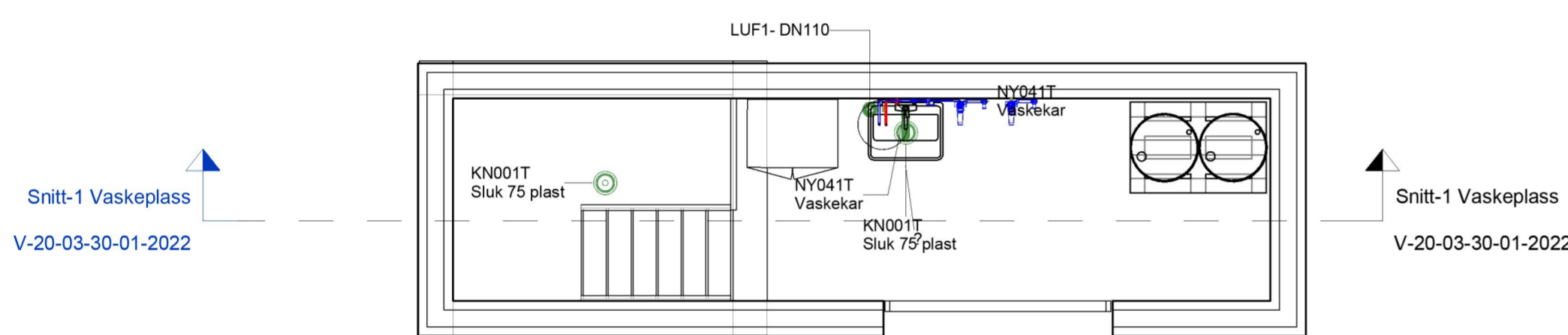

1 1.etg. Vaskeclass Utskrift
1 : 50

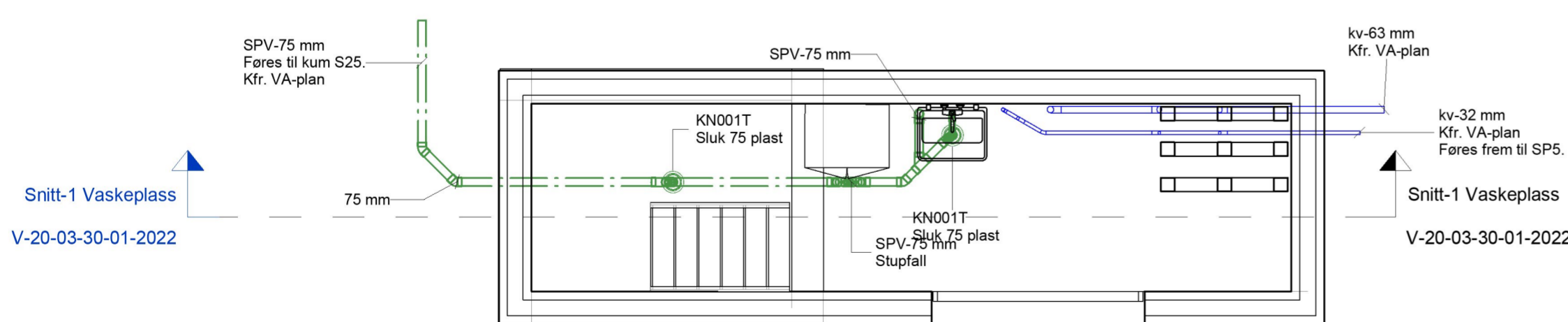

2 Bunnledninger Vaskeclass Utskrift
1 : 50

Tegn. nr	V-20-03-30-01-2022	Rev.
----------	--------------------	------

Tilbudstegning Totalentreprise	ED	SAL	09.02.23
Tilbudstegning Byggetrinn HEB	ED	SAL	04.04.22
Rev	Revideringen gjelder		Dato.
TEGN.	ED	DATO	
KONTR.	SAL	DATO	16.02.22
Målestokk:	1 : 50		
Status:	TILBUDSTEGNING		
Prosj.nr	2321		
Tegn. nr	V-20-03-30-01-2022	Rev.	



Ferkingstad og Alsaker
RÅDGIVENDE INGENIØRER VVS
Karmsundgt.159 - 5522 Haugesund - Tlf 52 70 53 60



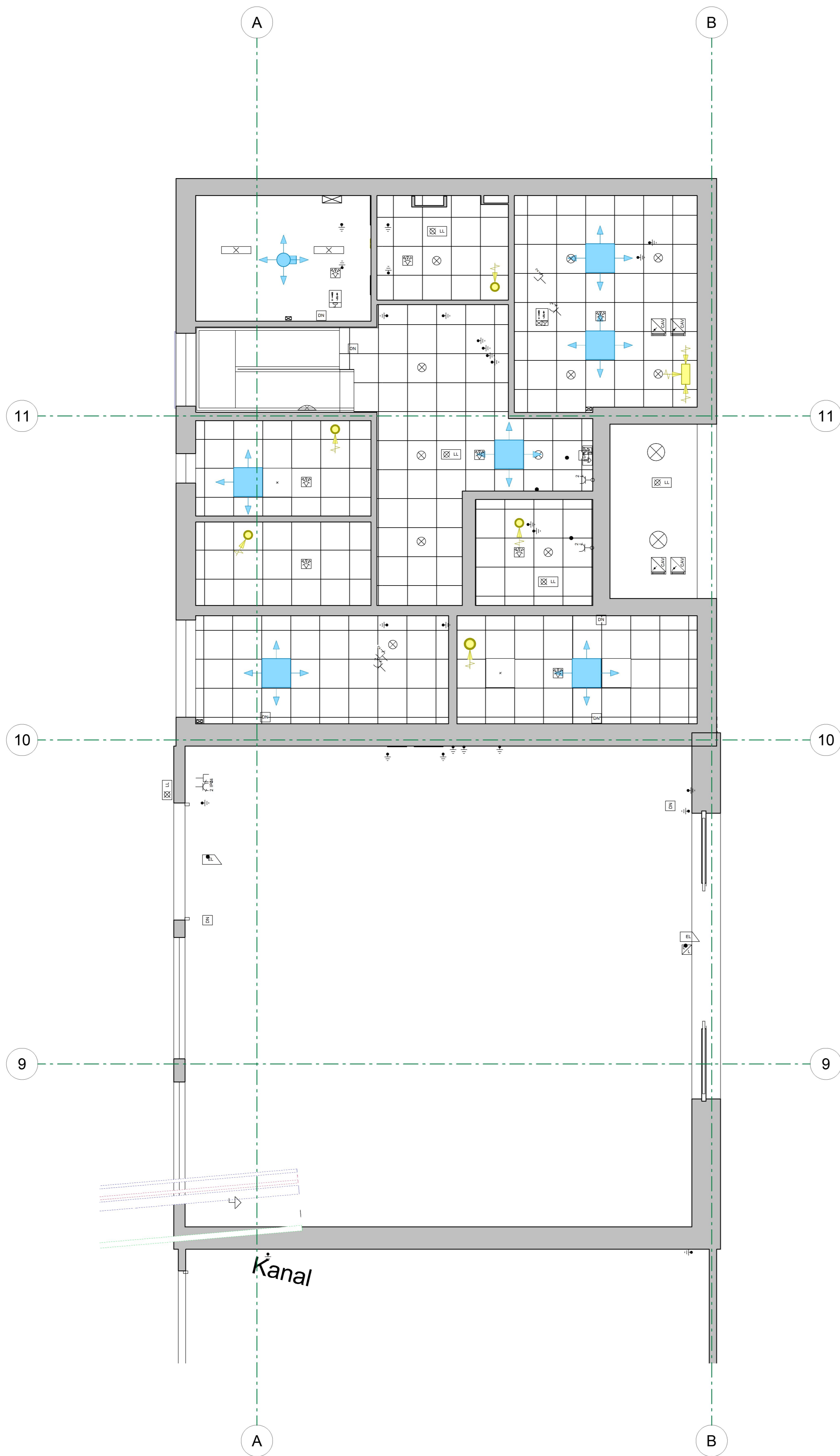

Rev	Tegn. nr	Rev.
	V-30-01-30-01-2022	

Tilbudstegning Totalentreprise		ED	SAL	09.02.23
Tilbudstegning Byggetrinn HEB		ED	SAL	04.04.22
Rev	Revideringen gjelder	Tegn.	Kontr.	Dato.
		ED		Dato.
KARMØY KOMMUNE		KONTR.	SAL	DATO
P56800 - NY GJENVINNGSSTASJON BORGAREDALEN				16.02.22
Himlingsplan 1.etg Del 1		Målestokk:	1 : 50	
		Status:	TILBUDSTEGNING	
		Prosj. nr	2321	
		Tegn. nr	V-30-01-30-01-2022	
		Rev.		



Ferkingstad og Alsaker
 RÅDGIVENDE INGENIØRER VVS
 Karmundgt. 159 - 5522 Haugesund - Tlf 52 70 53 80



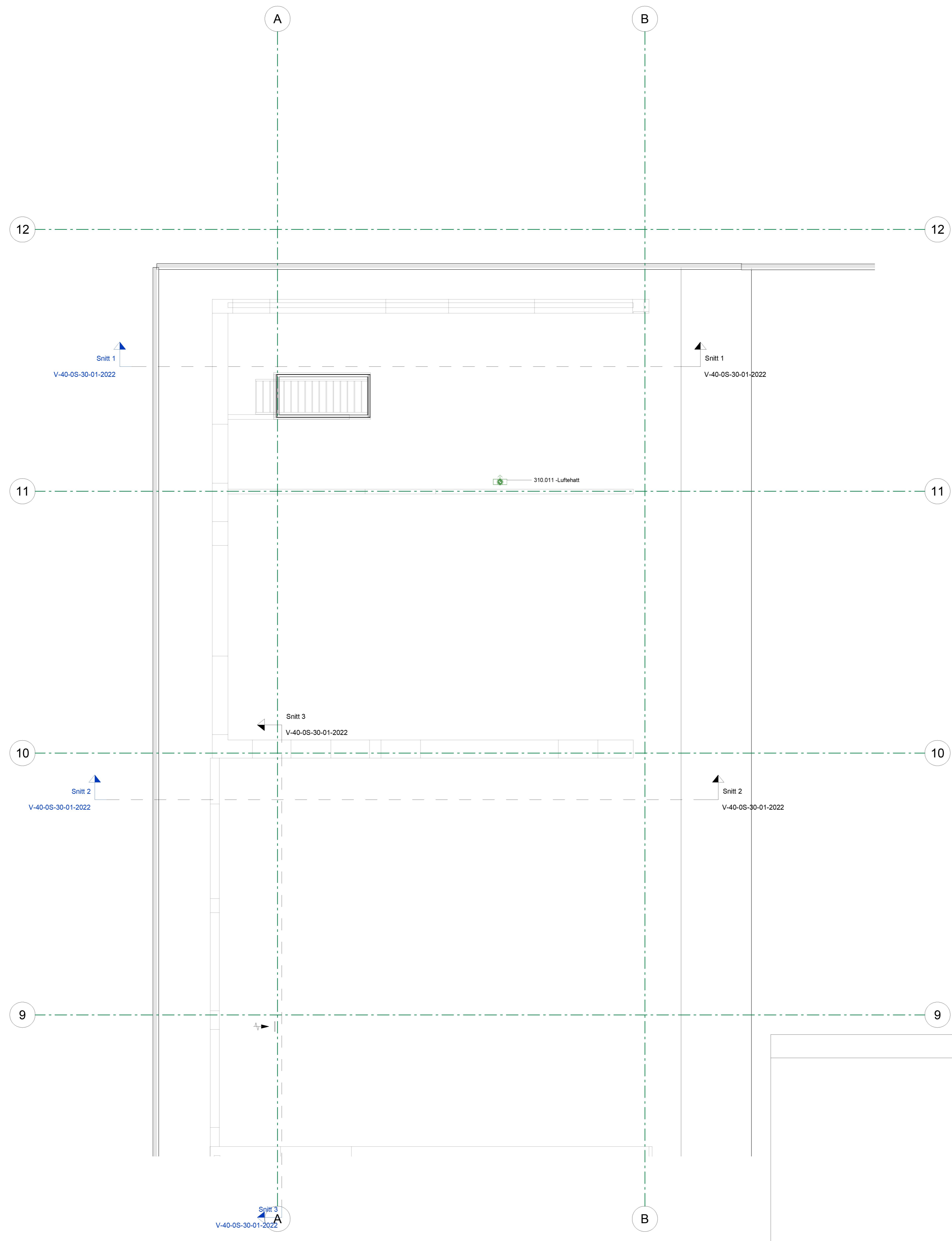

Tegn. nr	V-30-OT-30-01-2022	Rev.
----------	--------------------	------

Tilbudstegning Totalentreprise	ED	SAL	09.02.23
Tilbudstegning Byggetrinn HEB	ED	SAL	04.04.22
Rev	Revideringen gjelder	Tegn.	Kontr.
KARMØY KOMMUNE		TEGN	ED
P56800 - NY GJENVININGSSTASJON BORGAREDALEN		KONTR	SAL
Takplan Del 1		DATO	16.02.22
Målestokk:	1 : 50	Status:	TILBUDSTEGNING
Prosj nr	2321	Tegn. nr	V-30-OT-30-01-2022
Rev.		Rev.	



Ferkingstad og Alsaker
 RÅDGIVENDE INGENIØRER VVS
 Karmundgt. 159 - 5522 Haugesund - Tlf 52 70 53 80



FCB/MT: (564641)

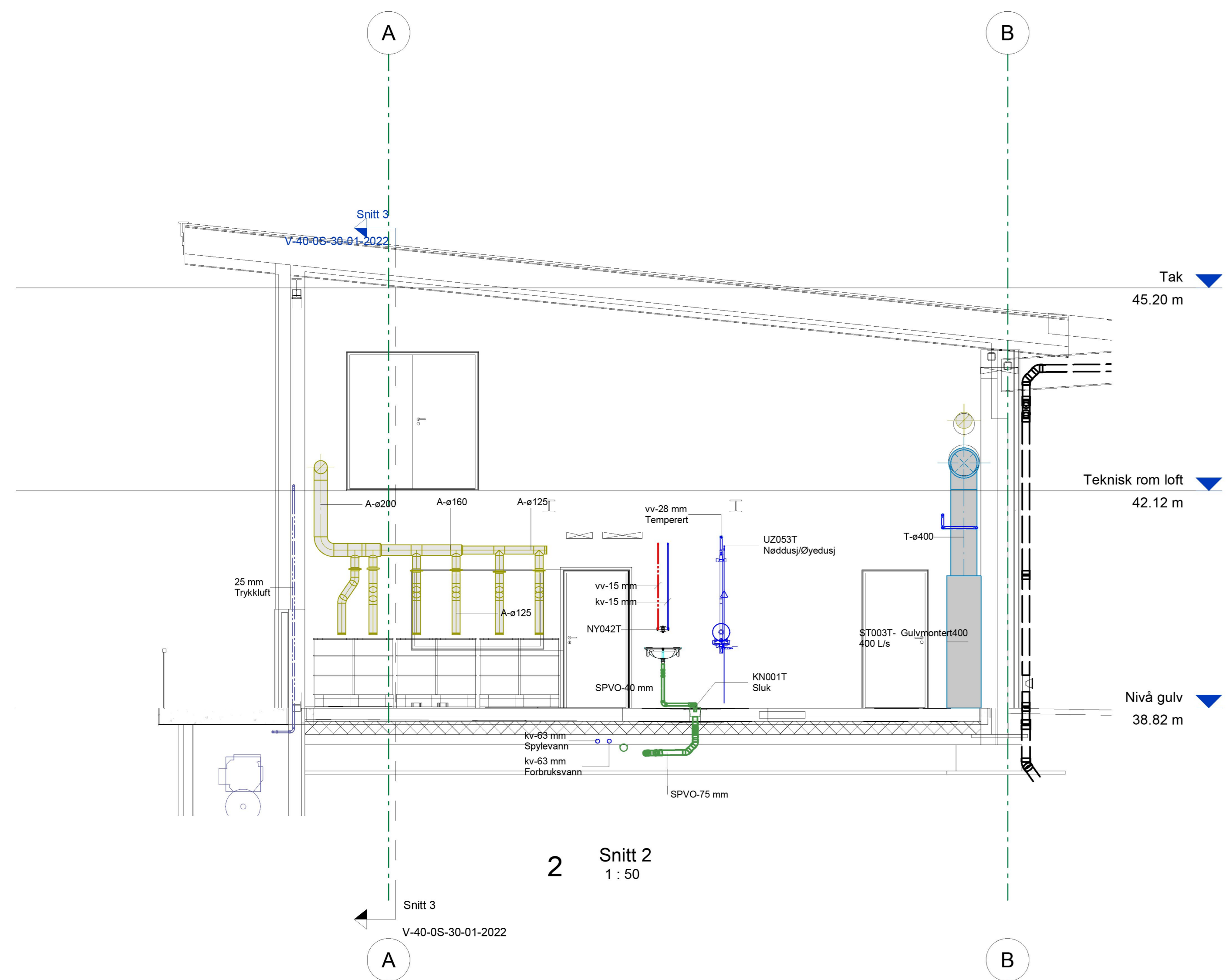

2 Snitt 2
1:50

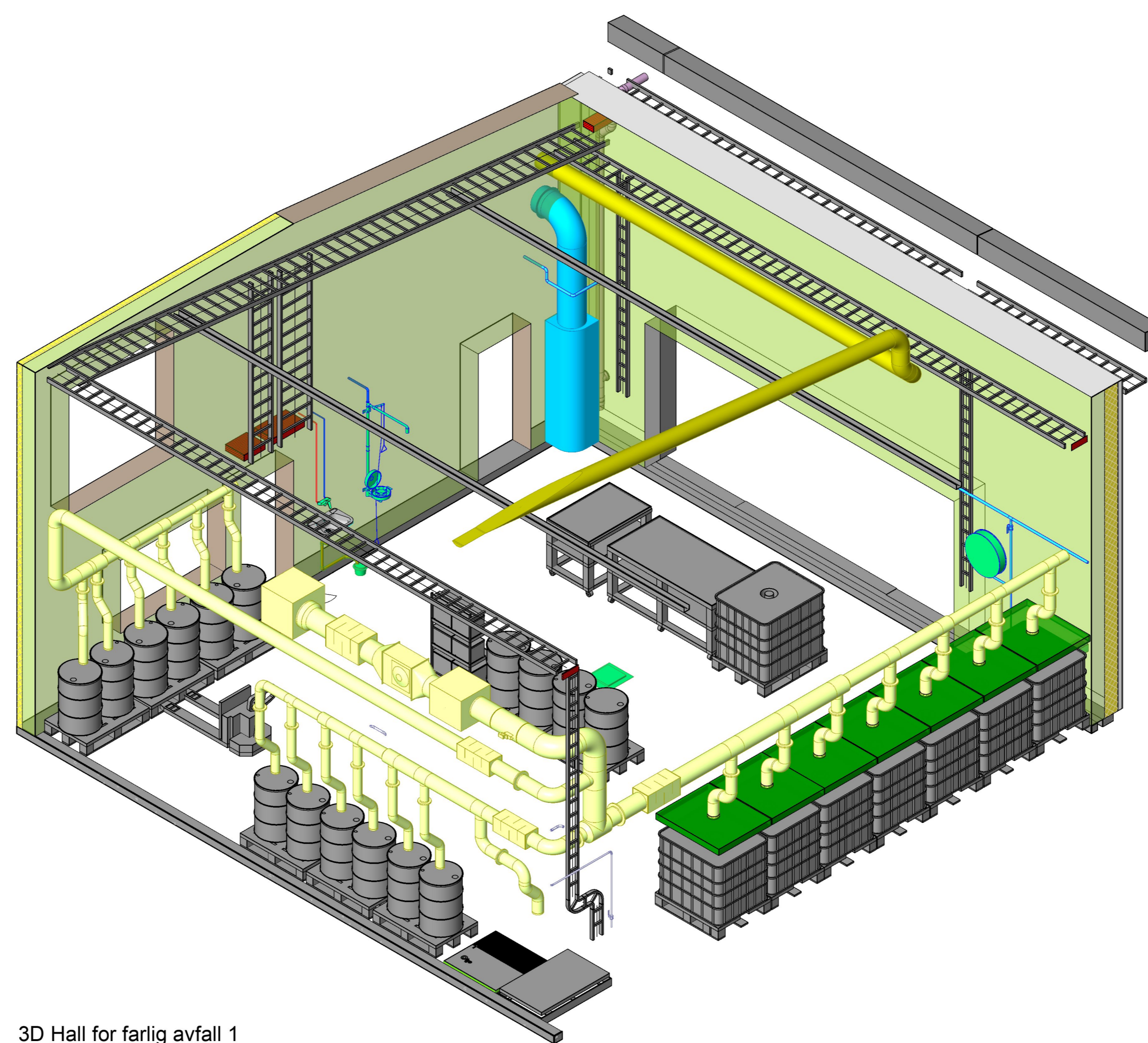

4 3D Hall for farlig avfall 1

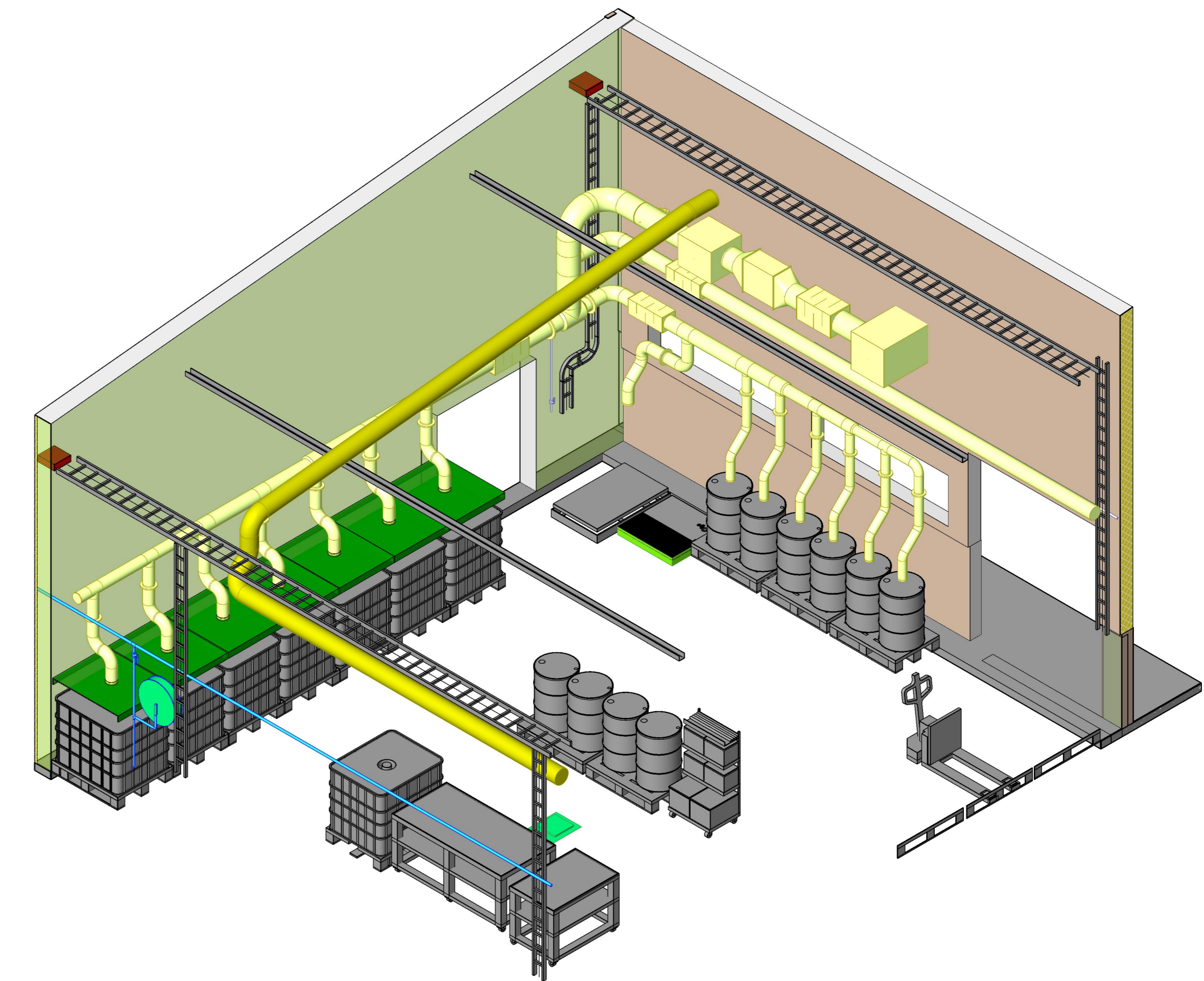

6 3D Hall for farlig avfall 2

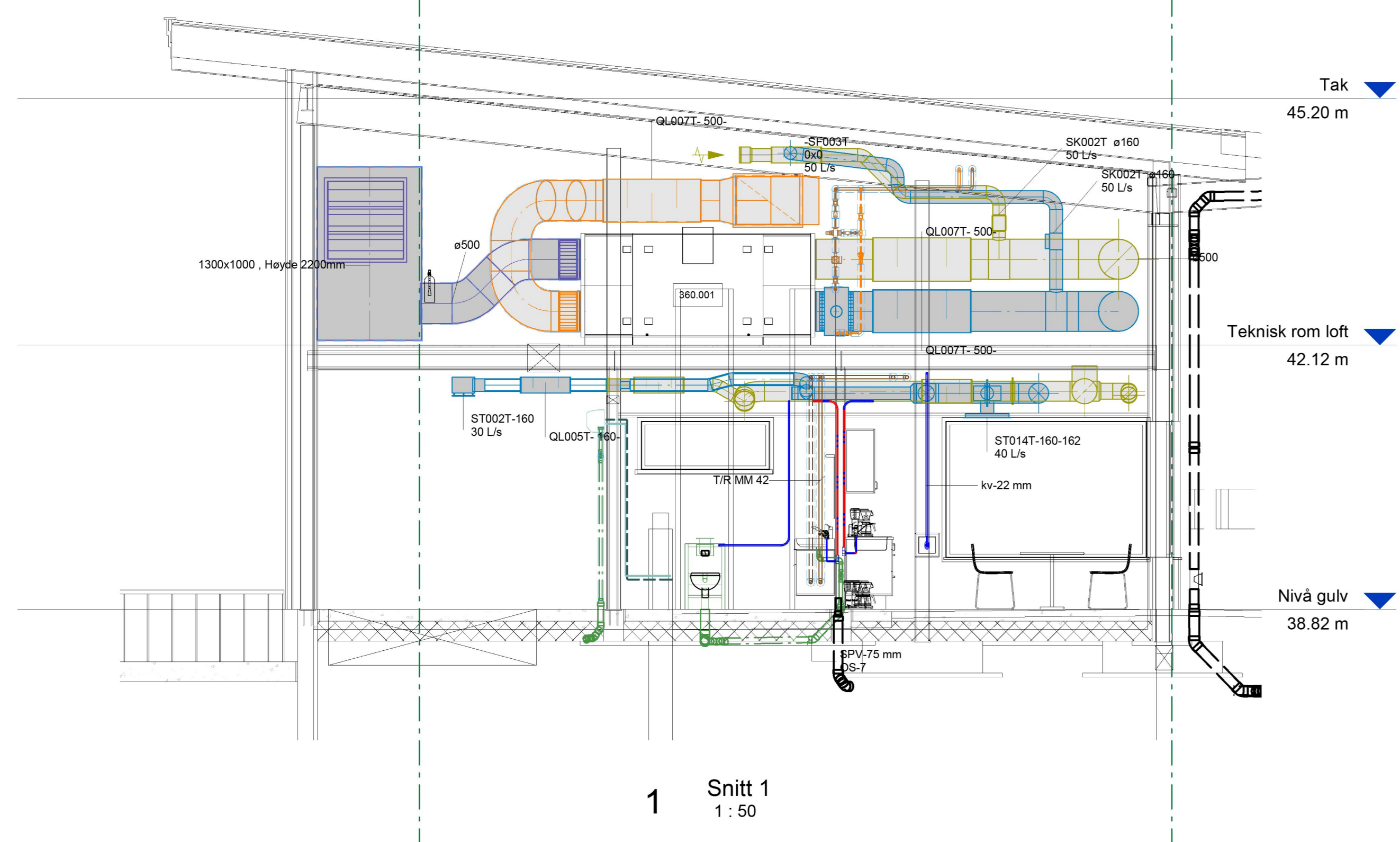

1 Snitt 1
1:50

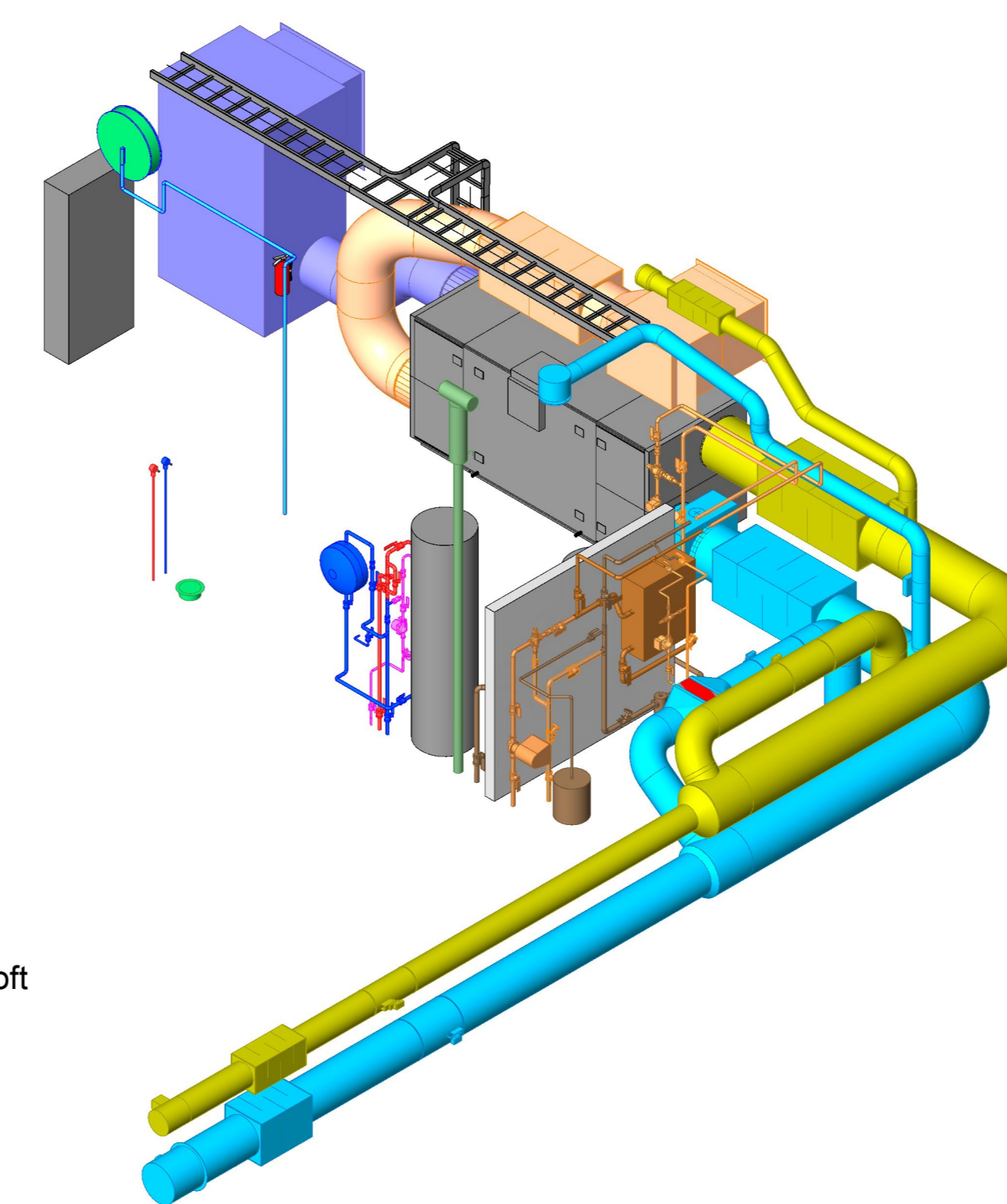

5 Teknisk rom loft

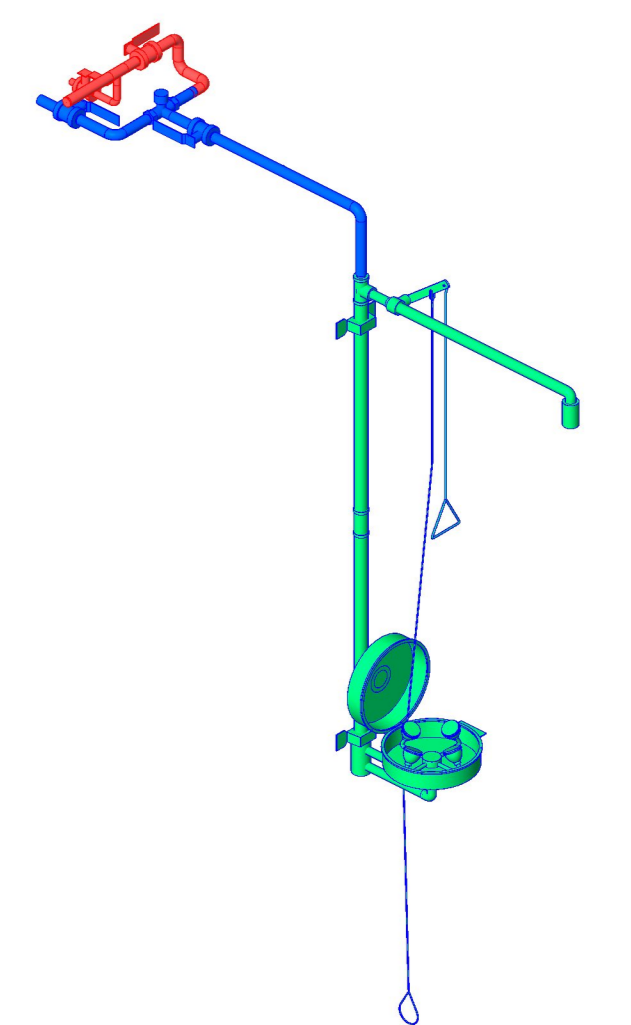

3 3D Nød og Øyedusj

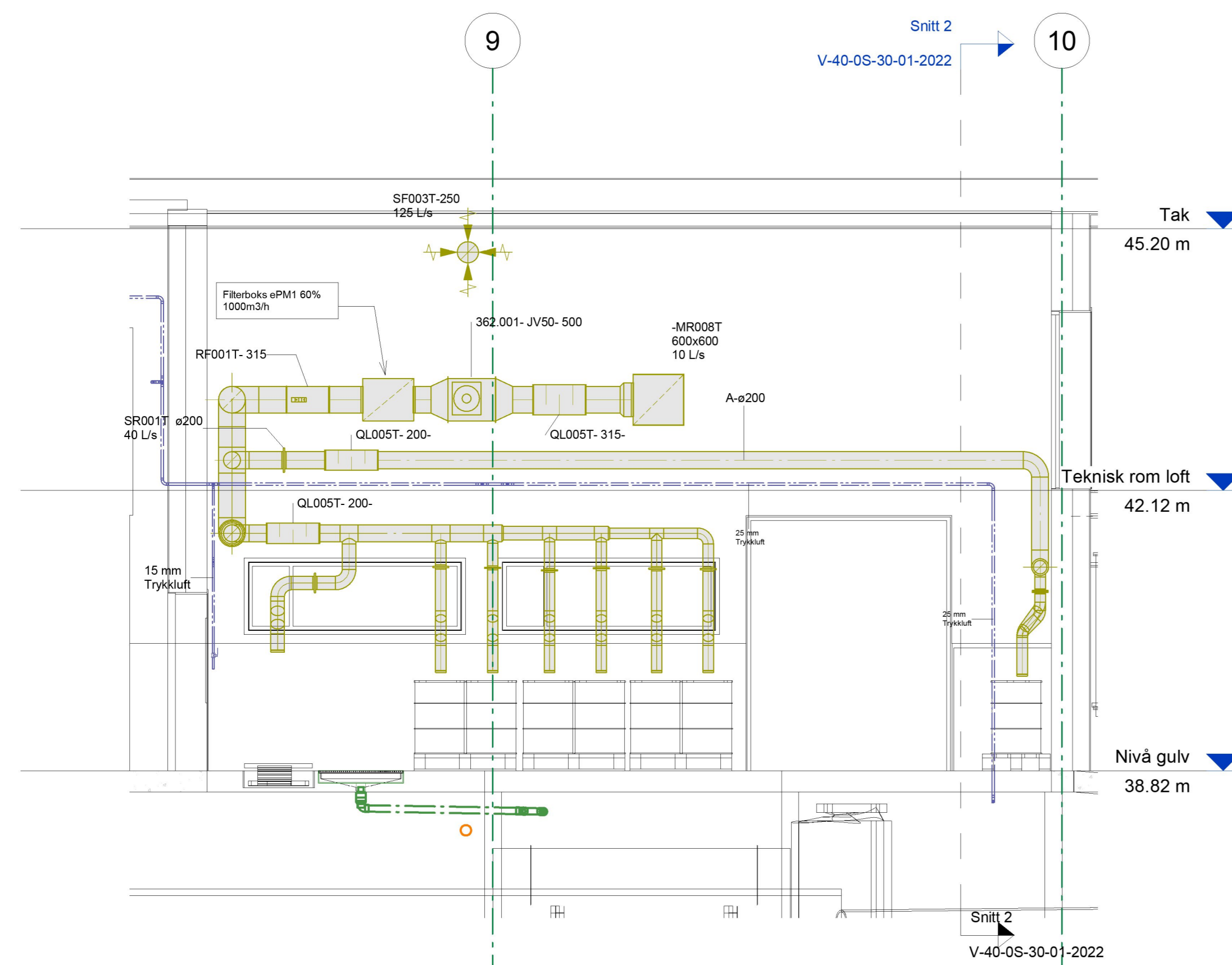

7 Snitt 3
1:50

Tilbudstegnning Totalentreprise		ED	SAL	09.02.23
Tilbudstegnning Ergonomi HSB		ED	SAL	04.04.22
Rev	Revideringen gjelder	Tegn	Kont	Dato
		ED	SAL	15.02.22
		SAL	SAL	16.02.22
Målestokk: 1:50		Status: TIL GJENNOMSYN		
Prosjekt nr: 2321		Rev:		
Karmøy Kommune		Ferkningstad og Alsaker		
P56800 - NY GJENVINNINGSTASJON BORGAREDALEN		Arkitekt: Karmøy Kommune		
Snitt & 3D		Karmøy 19. 5522 Høgskule - 79 53 70 50 80		
Side nr: V-40-05-30-01-2022		Rev:		

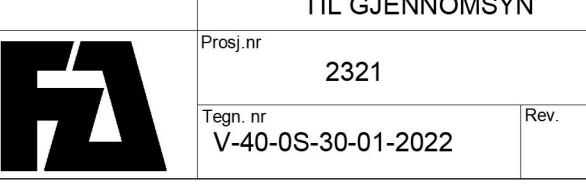

System 310.12
Oljeholdig spillvann / spillolje

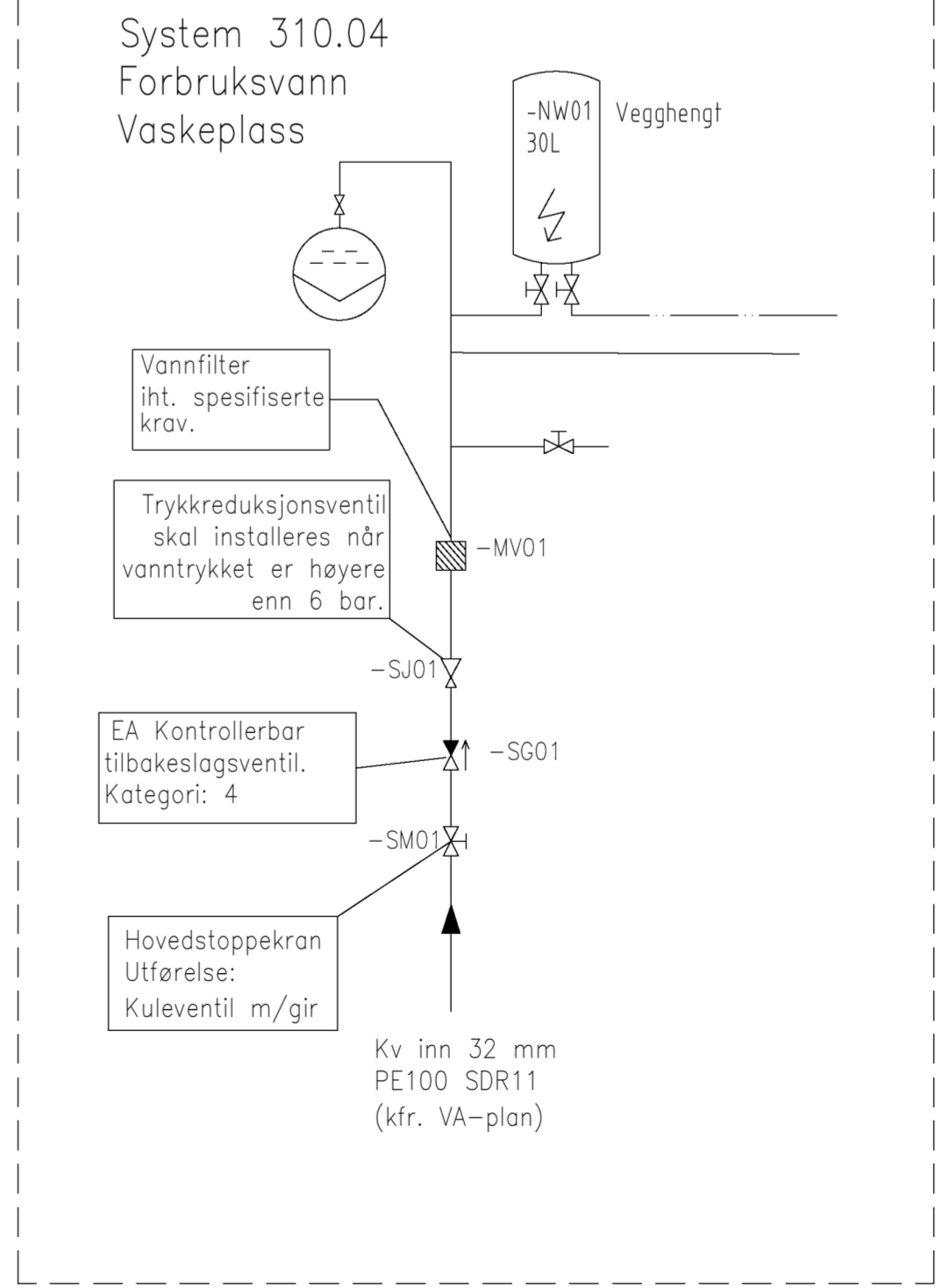
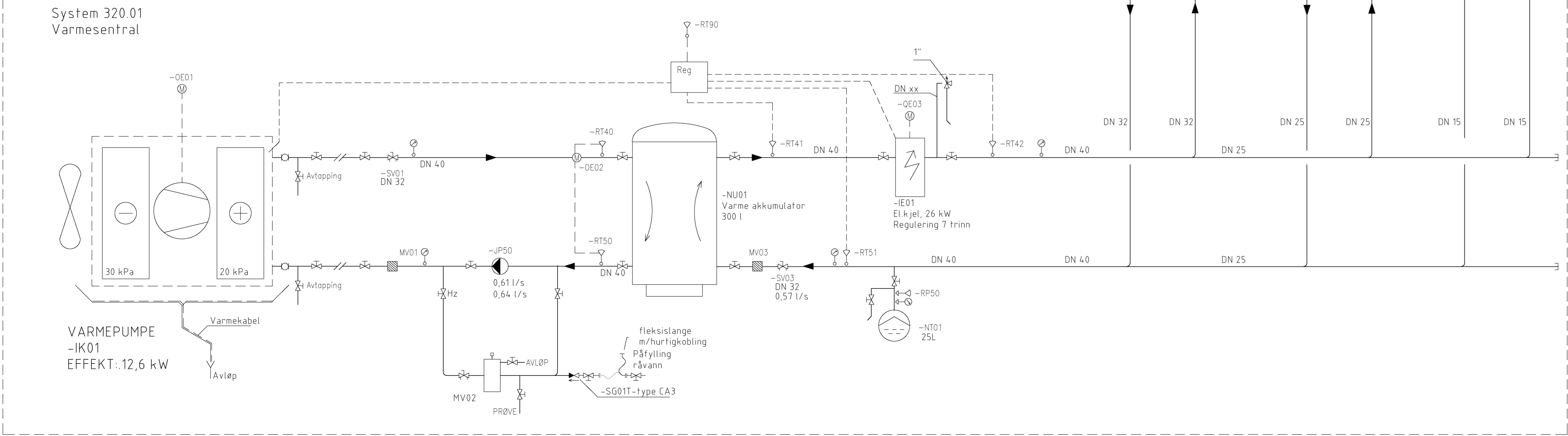
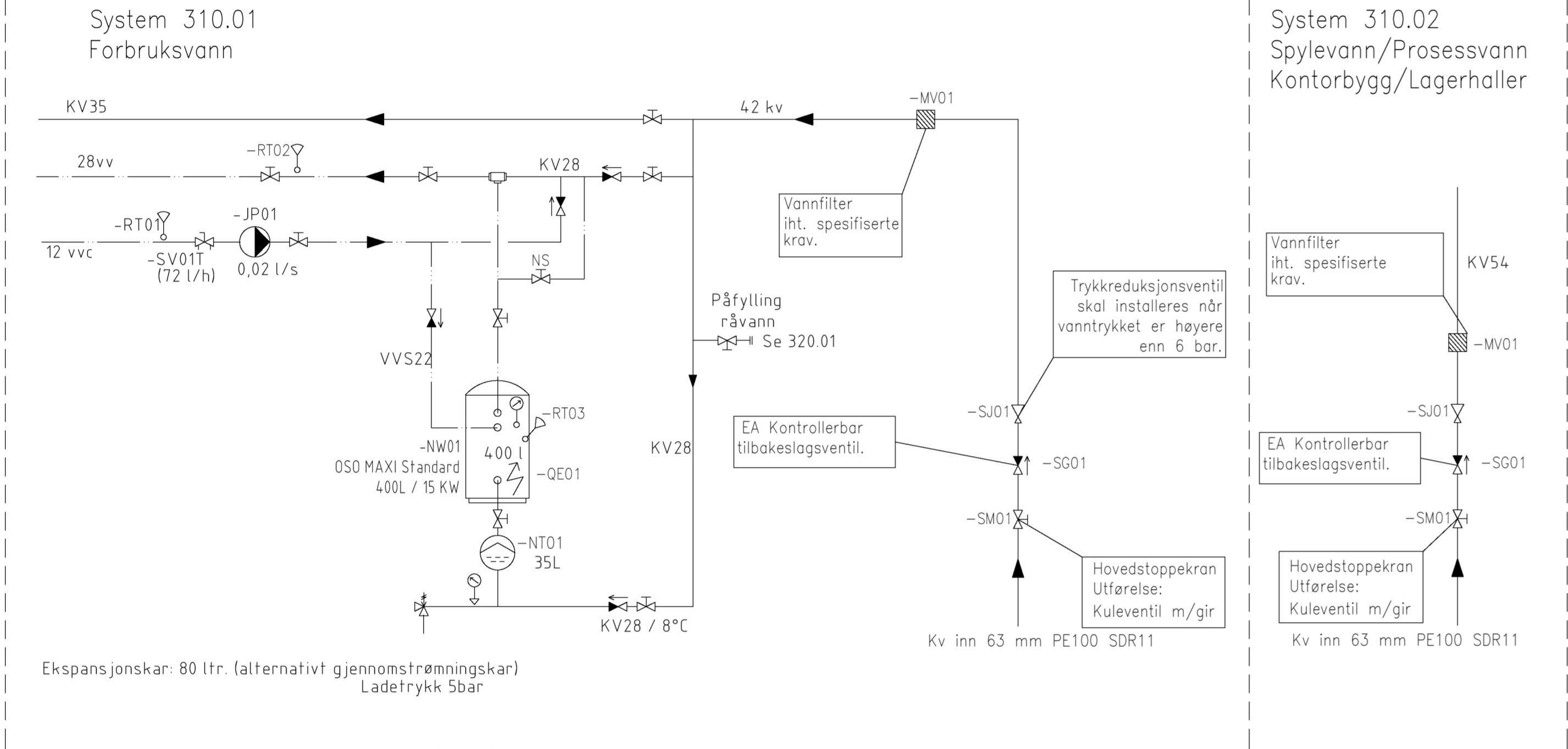
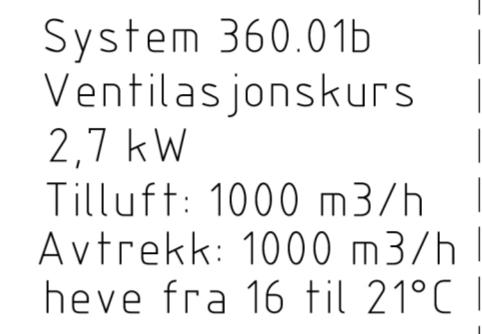
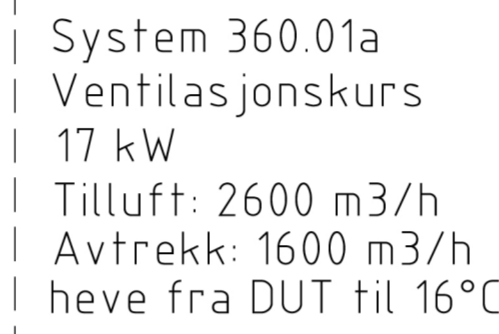
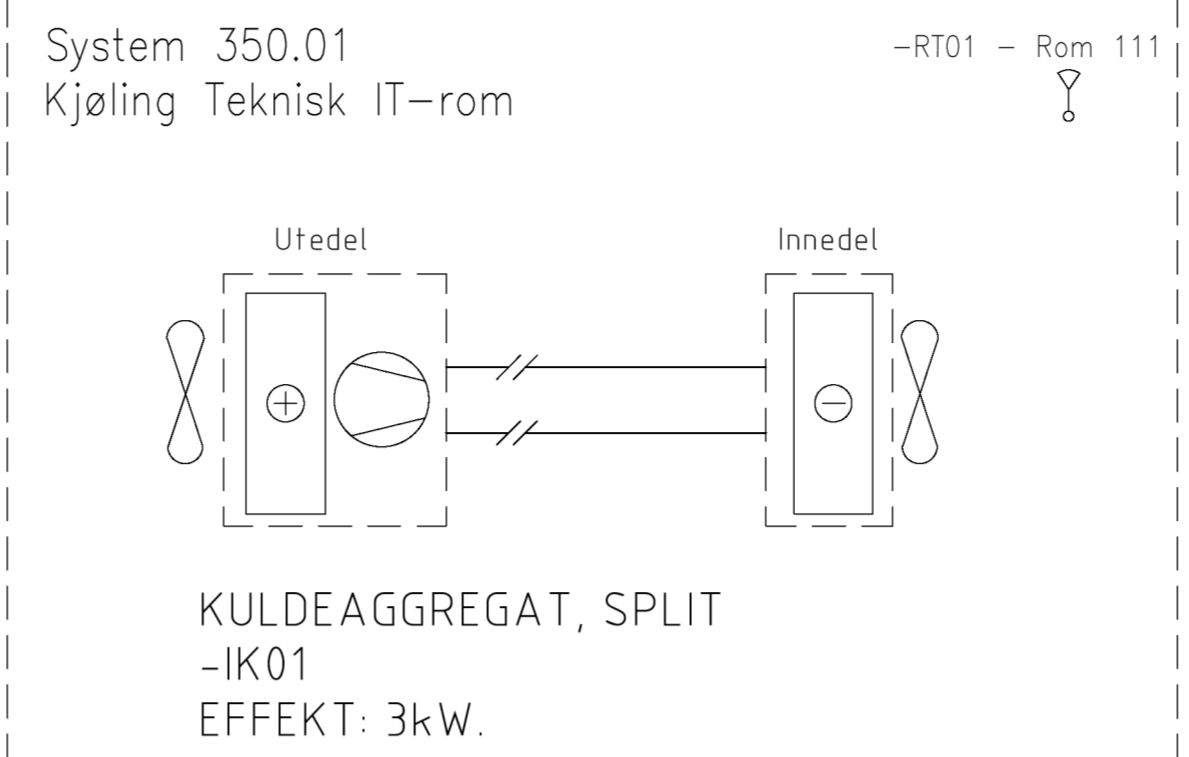
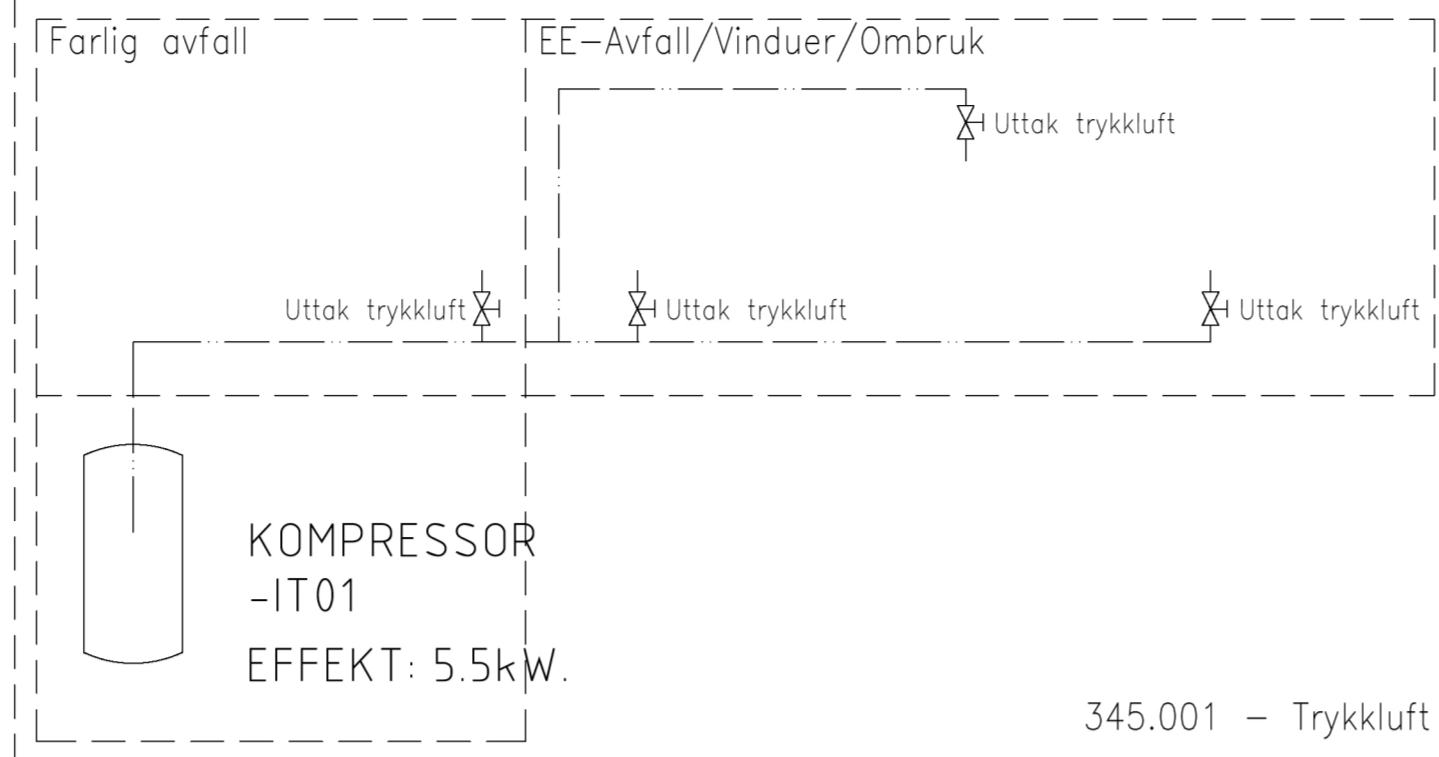
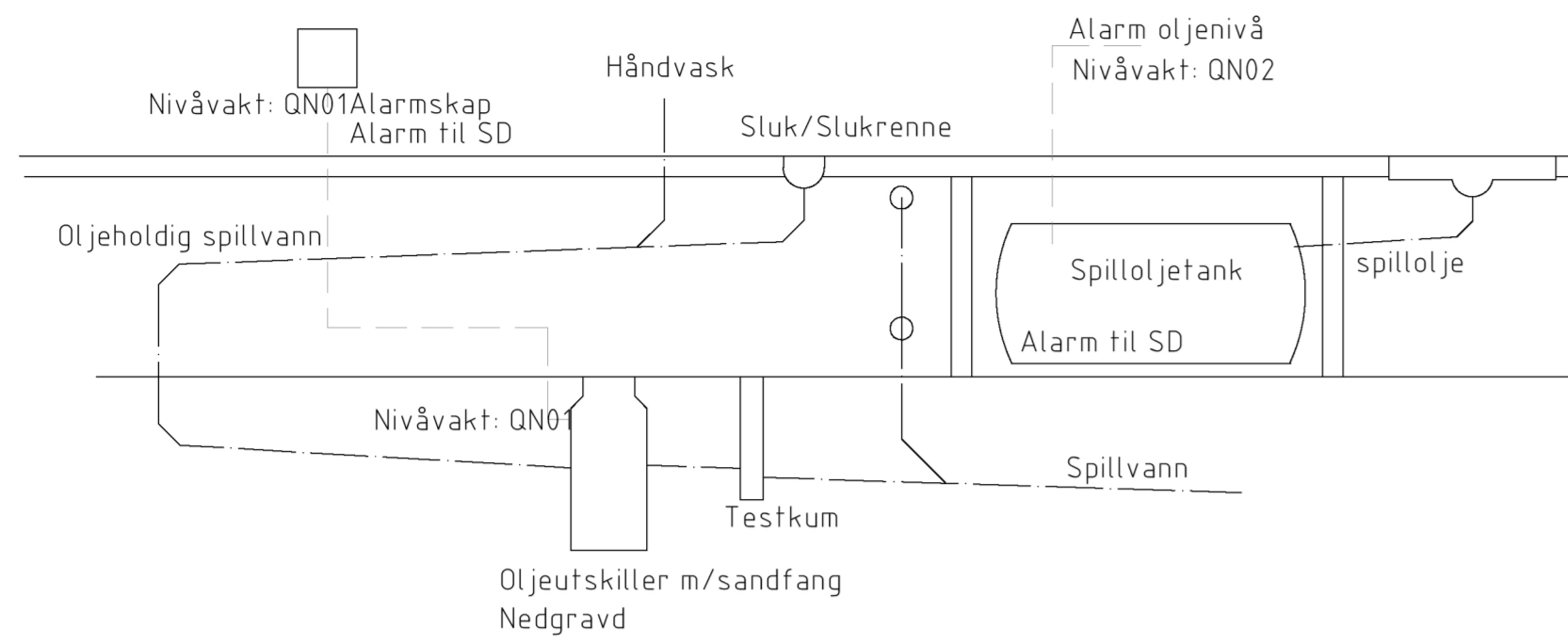

<ul style="list-style-type: none"> Avstengingsventil 2-veisventil, modulerende Trykkavhengig 2-veisventil, Åpav/steng Trykkreduksjonsventil Tilbakeslagsventil Reguleringsventil m/målestak Trykkavhengig ventil Sikkerhetsventil 3-veisventil, modulerende Filter Kondenspolette Vakuumventil Microbleufskiller Kompensator (CO) Fastpunkt Styring Plugg Bindlens Pumpe Tvillingpumpe 	<ul style="list-style-type: none"> Temperaturmåler (Termometer) Temperaturgiver Termostal Trykkmåler (Manometer) Trykkgiver Pressostat Mengdemåler Mengdegiver Strømsgiver Hastighetsgiver Fukighetsmåler Fukighetsgiver Hygroskop Entsøgiver Motor, modulerende Motor, av/på Filtervakt CO2-føler Buskommunikasjon Energimåler (fleksibel) Temperaturgiver på tur og retur Energimåler (elektrisk) Ekspansjonskar Kjøli for fast Brensel 	<ul style="list-style-type: none"> Gassfyllt kjøli Dørfyllt kjøli Elektrisk Akkumulatortank VVB - varmbrennt oppvarmet VVB el. oppvarmet Varmerest
--	--	---

Tegning nr. **V-70-0X-30-01-2022-Energianlegg**

TILBUDSTEGNING TOTALENTPREISE	ED	09.02.23
TILBUDSTEGNING	ED	04.04.22
REV. TEKST	SIGN	DATE
KARMØY KOMMUNE	TEGN	ED
P56800 - NY GJENVINNINGSTASJON BORGAREDALEN	KONTR. SAL	DATE
SYSTEMSKJEMA ENERGIANLEGG	REVISJON	-
TRYKKLUFT, KJØLING, FORBRUKSVANN OG OLJEHOLDIG SPILLVANN	Prosjekt	2321
Ferkingstad og Alsaker	RÅDGIVENDE INGENIØRER VVS	Rev.
Karmøysgt 58 - 5522 Haugesund - Tlf 52 70 53 60 - Fax 52 70 53 66	V-70-0X-30-01-2022	



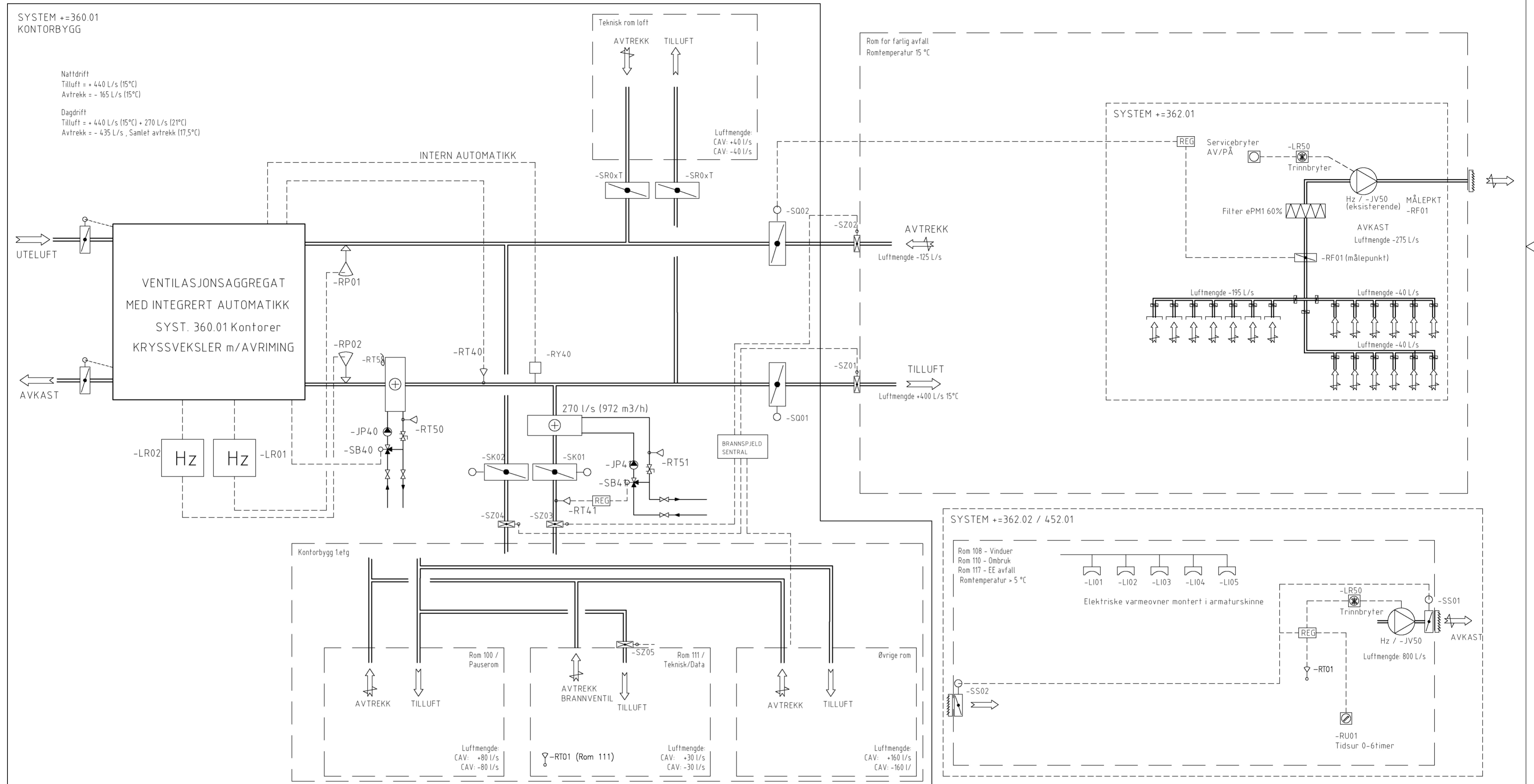

	TILBUDSTEGNING TOTALENTREPRISE	ED	09.02.23
	TILBUDSTEGNING	ED	04.04.22
REV.	TEKST	SIGN.	DATO
	KARMØY KOMMUNE	TEGN.	ED
	P56800 - NY GJENVINNGSSTASJON BORGAREDALEN	DATO	06.09.21
	SYSTEMSKJEMA VENTILASJONSANLEGG	KONTR.	SAL
	360.01 / 362.01 / 362.02	DATO	16.02.22
		GODKJ.	DATO
		Målestokk:	-
		Prosj.nr	2321
		Tegn. nr	V-70-0X-30-02-2022
		Rev.	

