

15m<sup>2</sup> BYA

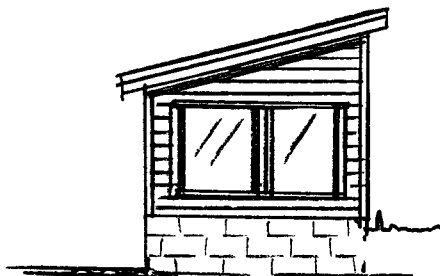

SØR VEST

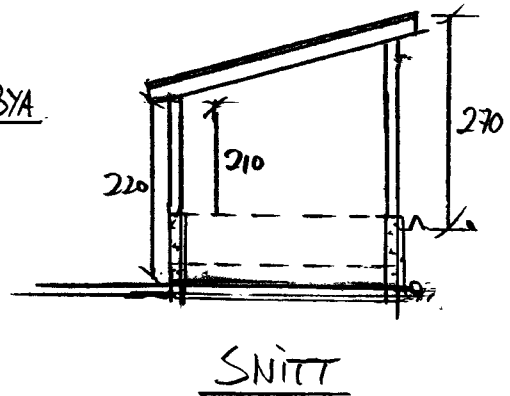
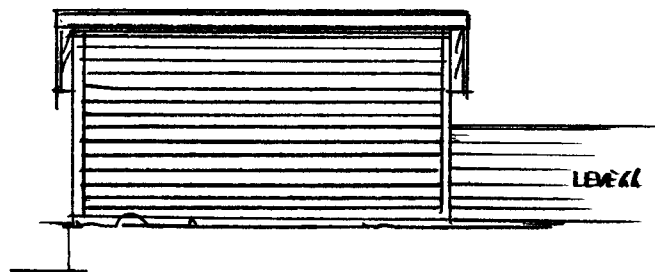

SØR ØST

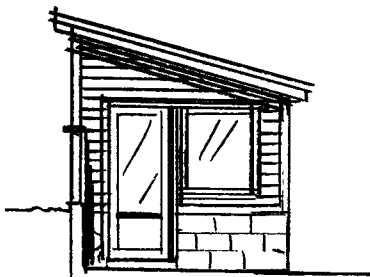

NØRD ØST

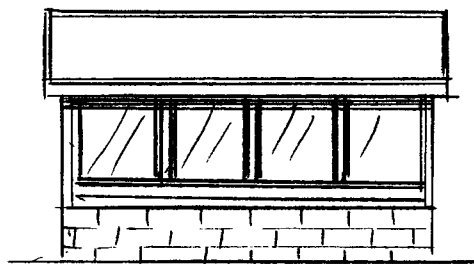

NØRD VEST

Dato	Konst/Tegnet	Godkjent	Målestokk	Gnr:
26.01.23			1:100	63
				Bnr: 187
HELGE TORGERSEN				VEKSTHUS/ HAGESTUE 15m <sup>2</sup>
HOGÅSV. 55		4250 KOPERVIK		
Tegn. nr. 1		PLAN/SNITT/FAS		

PLAN

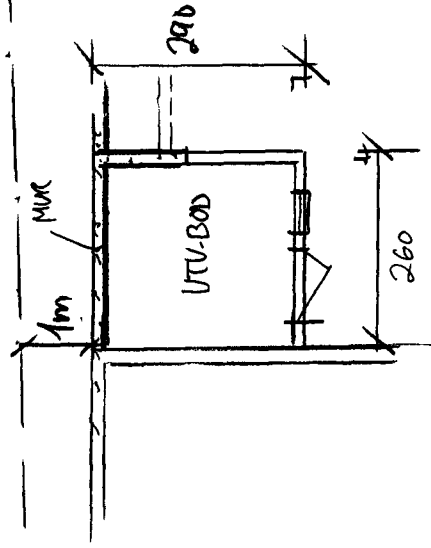

BYA = 7,5 m<sup>2</sup>

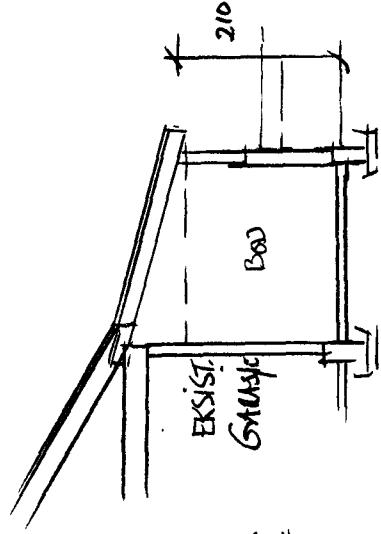

SNITT

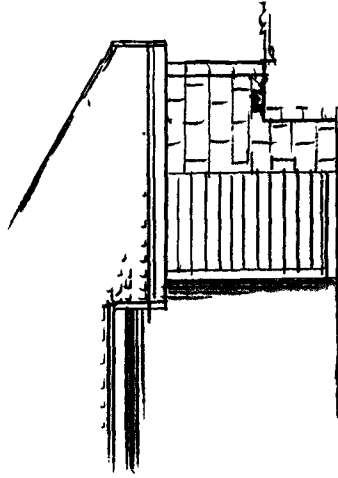

SØR ØST

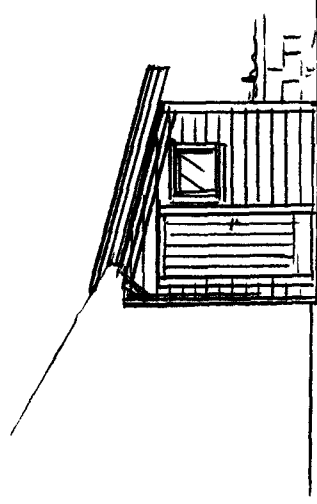

SØR VEST

( IKKE SYNLIG )

NORD VEST

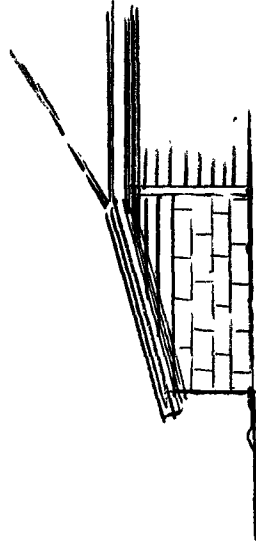

NORD ØST

Dato	Konst/Tegnet	Godkjent	Målestokk	Gnr:	63
			1:100	Bnr:	187
HELGE TØRGERSEN					
HØRÅSV. 55 4250 KOPPERVIK					
Tegn. nr. 2	PLAN / SNITT / ÅRS		UTV. BOD v/SMÅSJE 7,5 m <sup>2</sup> BYA		

# PLAN

6.50

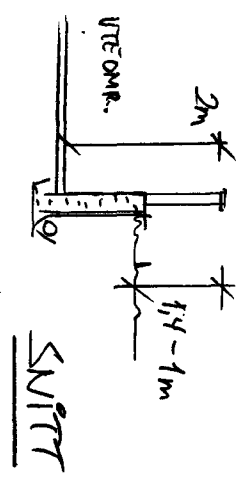
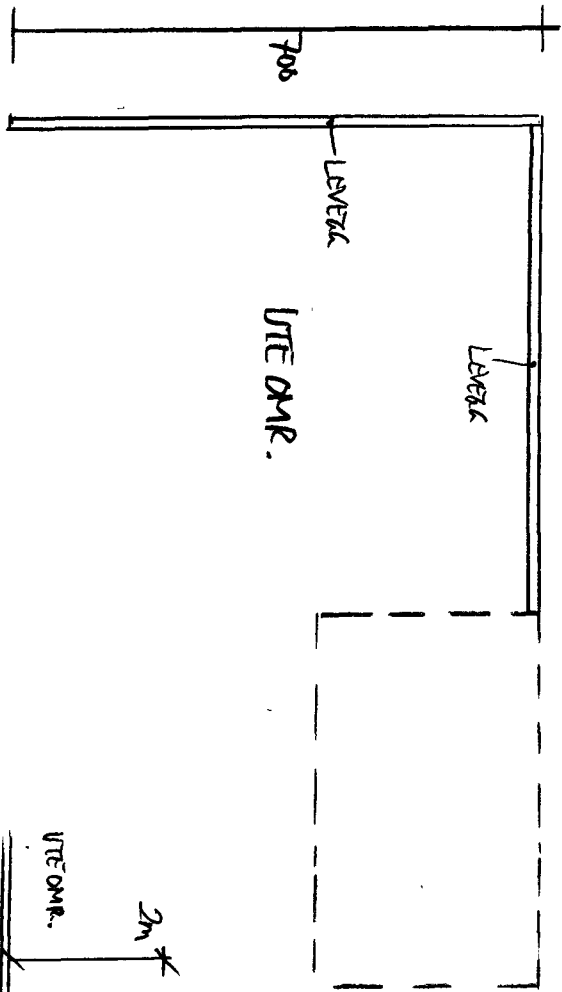

B&U

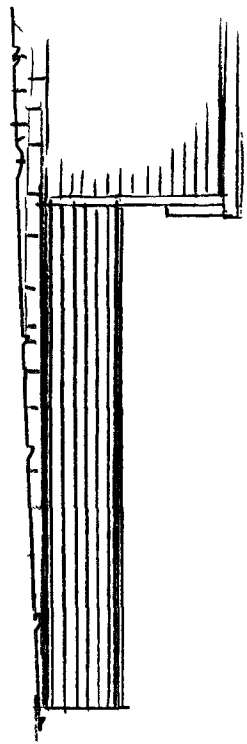

SØR ØST



NØR ØST

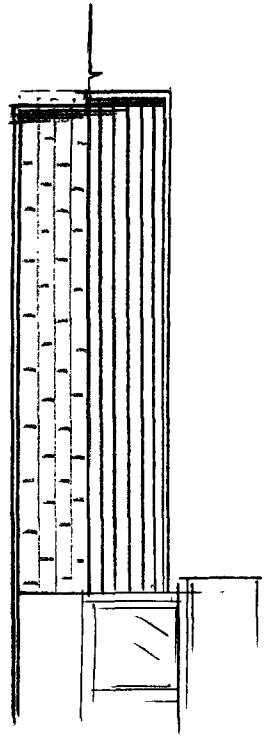

NØR VEST

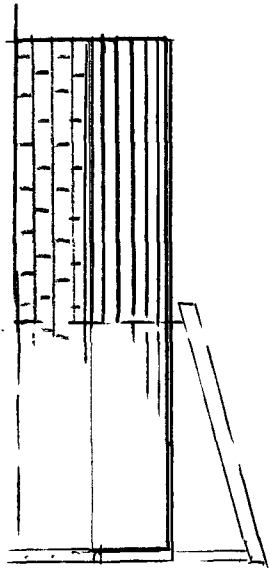

SØR VEST

Dato	Konstr/Tegnet	Godkjent	Målestokk	Gnr:
25.01.23			1:100	63
HELGÉ TORAGERSEN				Bnr: 187
HØRÅSV. 55 4250 UDPERM				LEVERÅ / UTE OMR.
Tegn. nr. 3	PUM/SVITTT/ERS			