

3 3D Oljeutskiller
Allerede montert

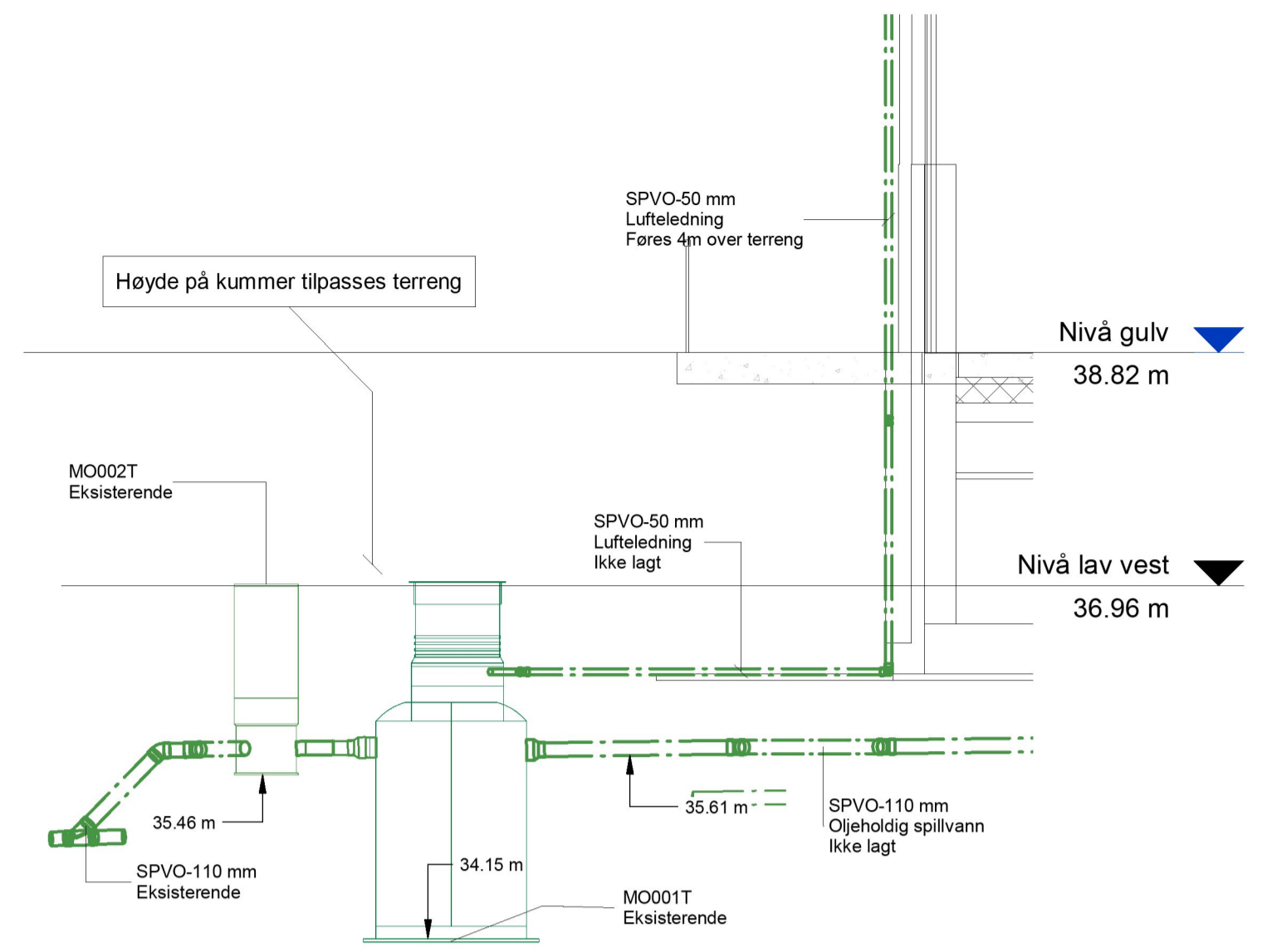

2 Snitt oljeutskiller
1 : 50

Tegn. nr V-10-UH-30-00-2021		Rev. B
TEGNFORKLARING		
Drens	---	
Spillvann	---	
Overvann	---	
Radonsikring	---	
Vannledning	---	
Overvannsrenne	---	
Taknedløp 6-13 avsluttes 2,5m over bakkenivå. Taknedløp 1-5-13 avsluttes ved taksluk		
Rev	Revideringen gjelder	Tegn. Kontr. Dato.
KARMØY KOMMUNE		ED DATO
P56800 - NY GJENVINNGSSTASJON BORGAREDALEN Utendørsplan VVS		KONTR. SAL DATO 16.11.22
Målestokk: As indicated		Status: TILBUDSTEGNING
Prosj nr 2321		Tegn. nr V-10-UH-30-00-2021
Ferkingsstad og Alsaker RÅDGIVENDE INGENIØRER VVS Karmundgt. 159 - 5522 Haugestrand - TR 52 70 53 80		Rev. B



FCB/BAIT (8416294)

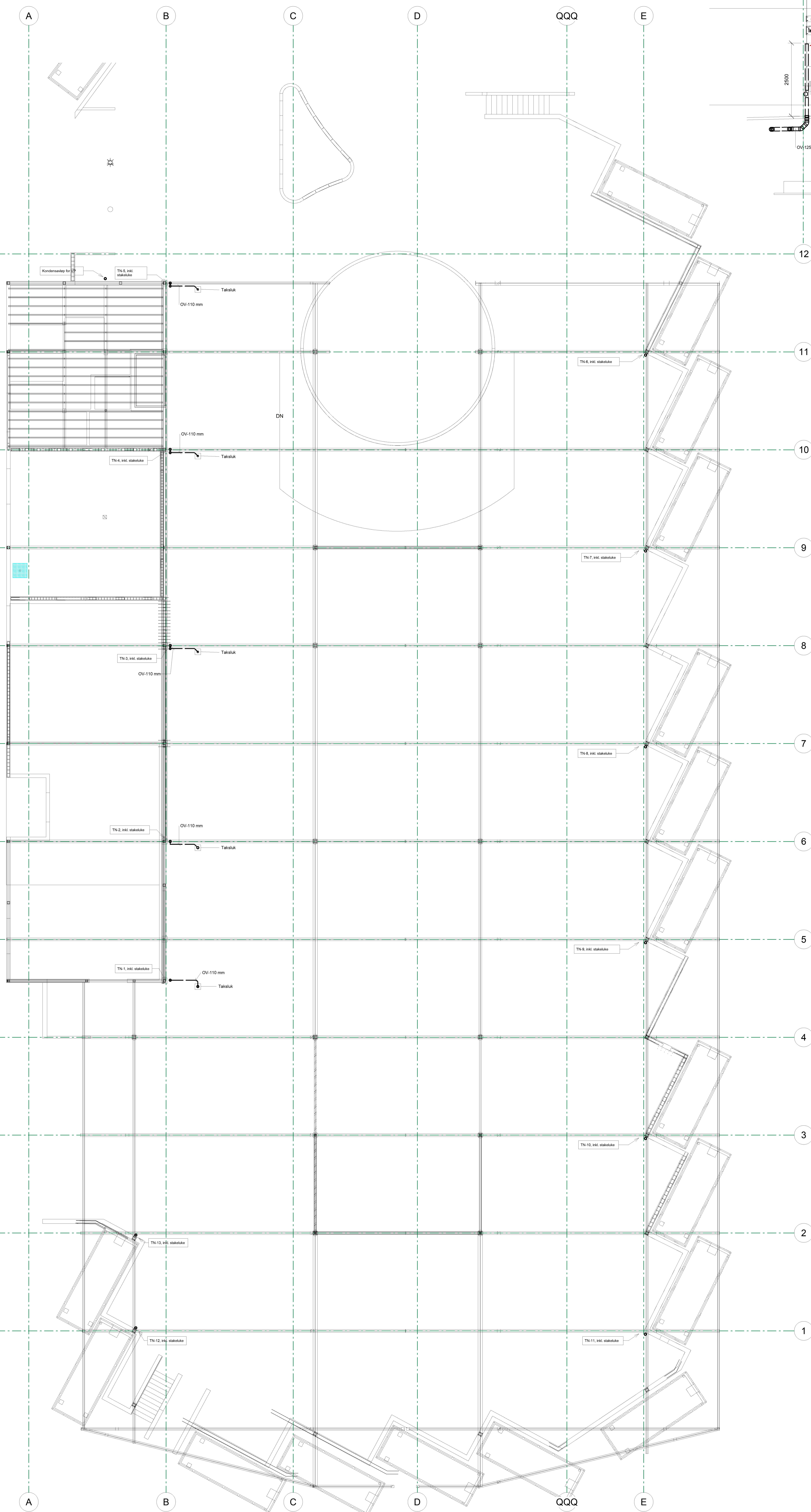

1 Plan under yttertak - Utskrift
1 : 100

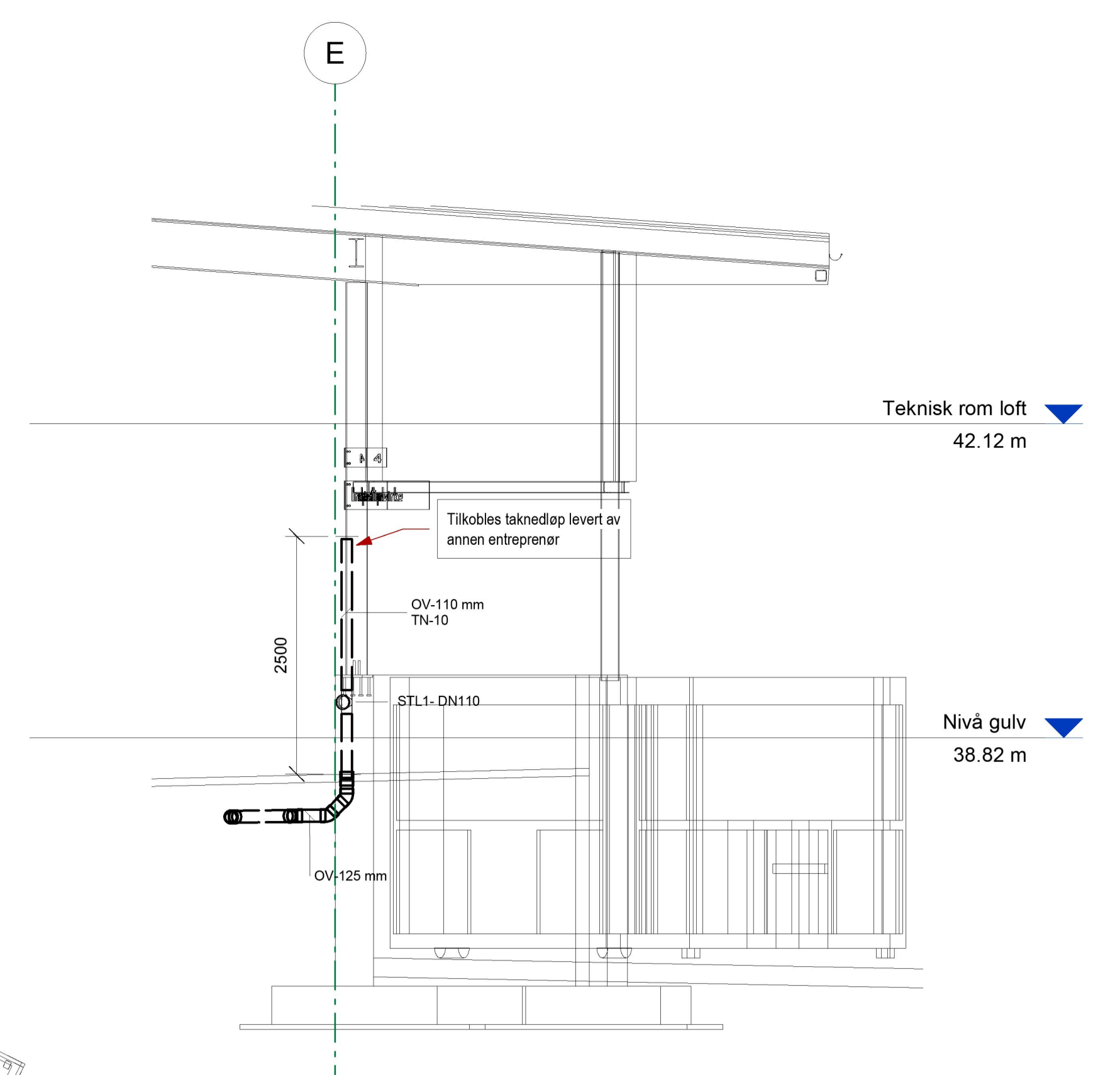

2 Prinsipp taknedløp1
1 : 50

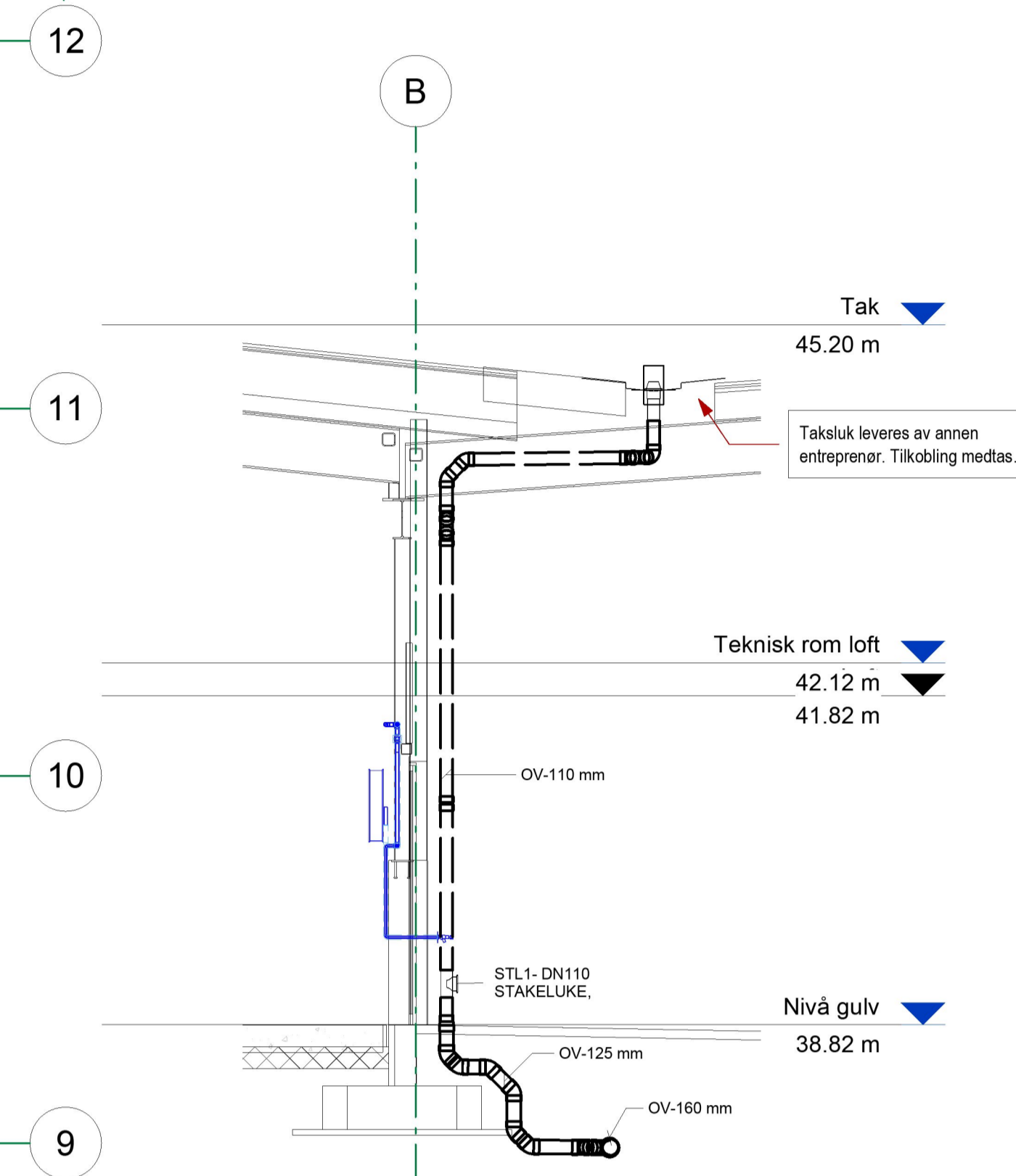

3 Prinsipp taksluk
1 : 50

TEGNFORKLARING		Typ. nr	Rev.
Drens	---	V-10-UH-31-01-2022	
Spillvann	---		
Overvann	---		
Radonsikring	---		
Vannledning	---		
Overvannsrenne	---		

Taknedløp 6-13 avsluttes 2.5m over bakkenivå.
Taknedløp 1-5-13 avsluttes ved taksluk

Rev.	Rev.	Rev.	Rev.
Tilbudstegning Totalentreprise	ED	SAL	09.02.23
Tilbudstegning Byggetrinn H&B	ED	SAL	04.04.22
Reviseringen gjelder	Tegn.	Kont.	Dato.
KARMØY KOMMUNE		ED	SAL
P56800 - NY GJENVINNSSTASJON BORGAREDALEN		KONTRE	SAL
Overvann fra sedumtak		Årsnavn	14.03.22
		Status	As indicated
		Prosjekt	TILBUDSTEGNING
		Prosjekt nr	2321
		Oppr nr	V-10-UH-31-01-2022



Ferkingstad og Alsaker



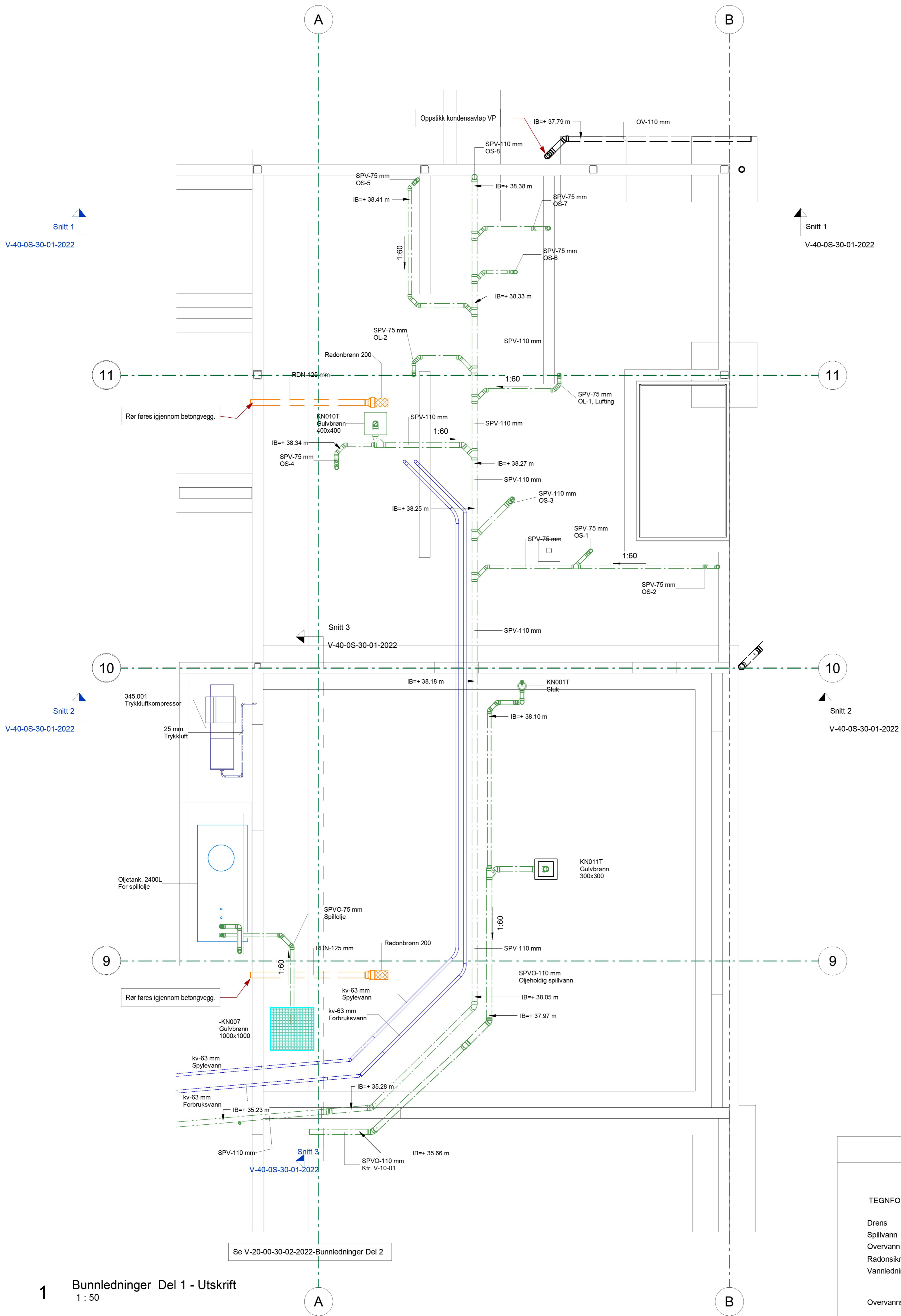

1 Bunnledninger Del 1 - Utskrift
1 : 50

Se V-20-00-30-02-2022-Bunnledninger Del 2

Rev	Tegn. nr	Rev.
	V-20-00-30-01-2022	

TEGNFORKLARING

Drens	
Spillvann	
Overvann	
Radonsikring	
Vannledning	
Overvannsrenne	

Tilbudstegning Totalentreprise	ED	SAL	09.02.23
Tilbudstegning Byggetrinn HEB	ED	SAL	04.04.22
Rev	Tegn.	Kontr.	Dato.
KARMØY KOMMUNE		ED	DATO
P56800 - NY GJENVININGSSTASJON BORGAREDALEN		KONTR	SAL
Bunnledninger Del 1		DATO	16.02.22
Målestokk:		As indicated	
Status:		TILBUDSTEGNING	
Prosj nr		2321	
Tegn. nr	Rev.		
V-20-00-30-01-2022			



Ferkingstad og Alsaker
RÅDGIVENDE INGENIØRER VVS
Karmsundgt. 159 - 5522 Haugesund - Tlf 52 70 53 80



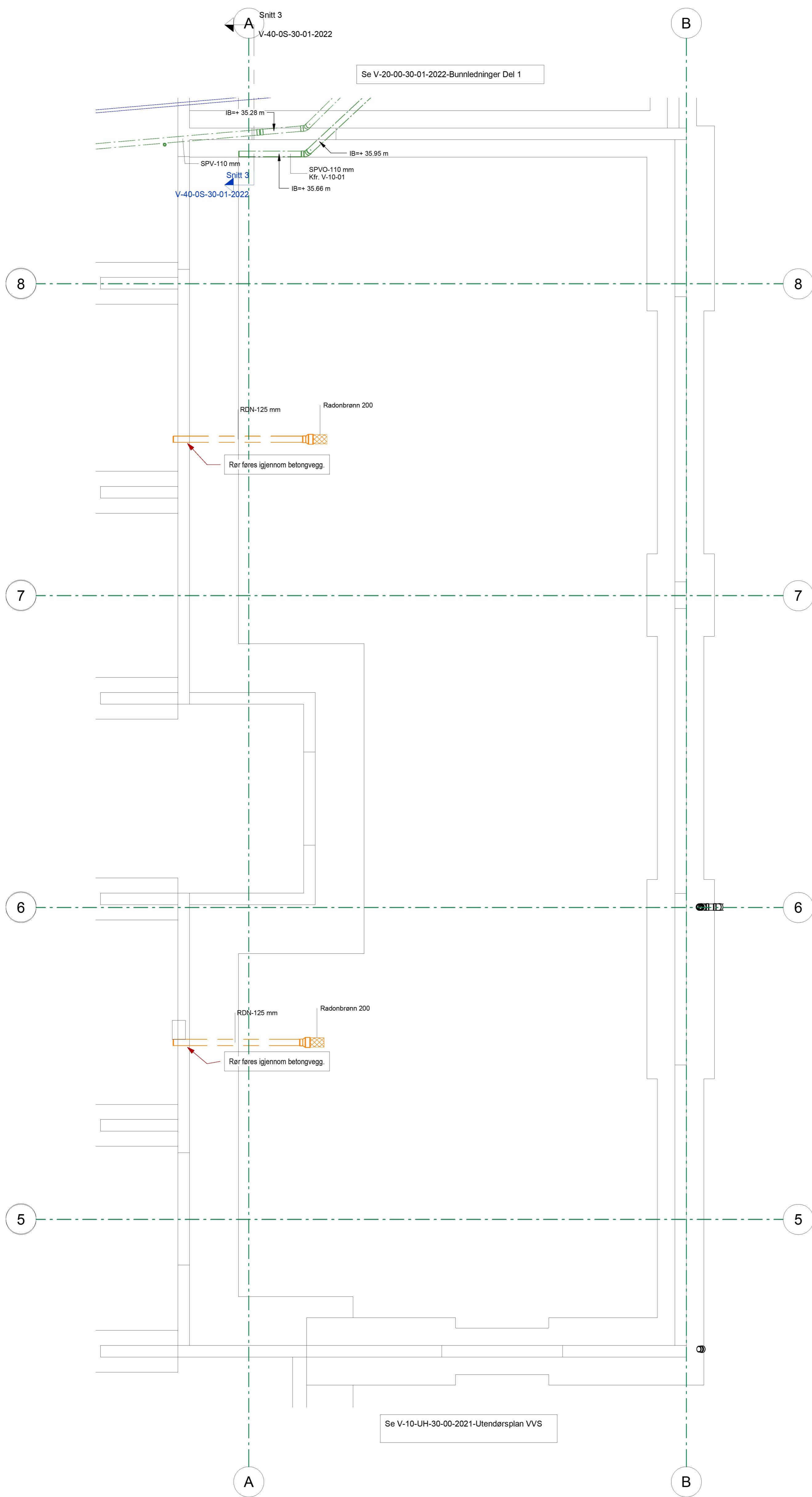

Se V-20-00-30-01-2022-Bunnledninger Del 1

Snitt 3
V-40-0S-30-01-2022

SPV-110 mm
Snitt 3
V-40-0S-30-01-2022

SPVO-110 mm
Kfr. V-10-01
IB=+ 35.66 m

RDN-125 mm

Radonbrenn 200

Rør føres igjennom betongvegg.

RDN-125 mm

Radonbrenn 200

Rør føres igjennom betongvegg.

Se V-10-UH-30-00-2021-Utendørsplan VVS

1 Bunnledninger Del 2 - Utskrift
1 : 50

Tegn. nr V-20-00-30-02-2022		Rev.
TEGNFORKLARING		
Drens		
Spillvann		
Overvann		
Radonsikring		
Vannledning		
Overvannssrenne		
Rev	Tilbudstegning Byggetrinn HEB	Rev.
Rev	Tilbudstegning Totalentreprise	Rev.
Rev	Revideringen gjelder	Rev.
TEGN	ED	DATO
KONTR	SAL	DATO
Målestokk:	As indicated	
Status:	TILBUDSTEGNING	
Prosj.nr	2321	
Tegn. nr	V-20-00-30-02-2022	Rev.
ED	SAL	09.02.23
ED	SAL	04.04.22
TEGN	ED	DATO
KONTR	SAL	DATO
Målestokk:	As indicated	
Status:	TILBUDSTEGNING	
Prosj.nr	2321	
Tegn. nr	V-20-00-30-02-2022	Rev.



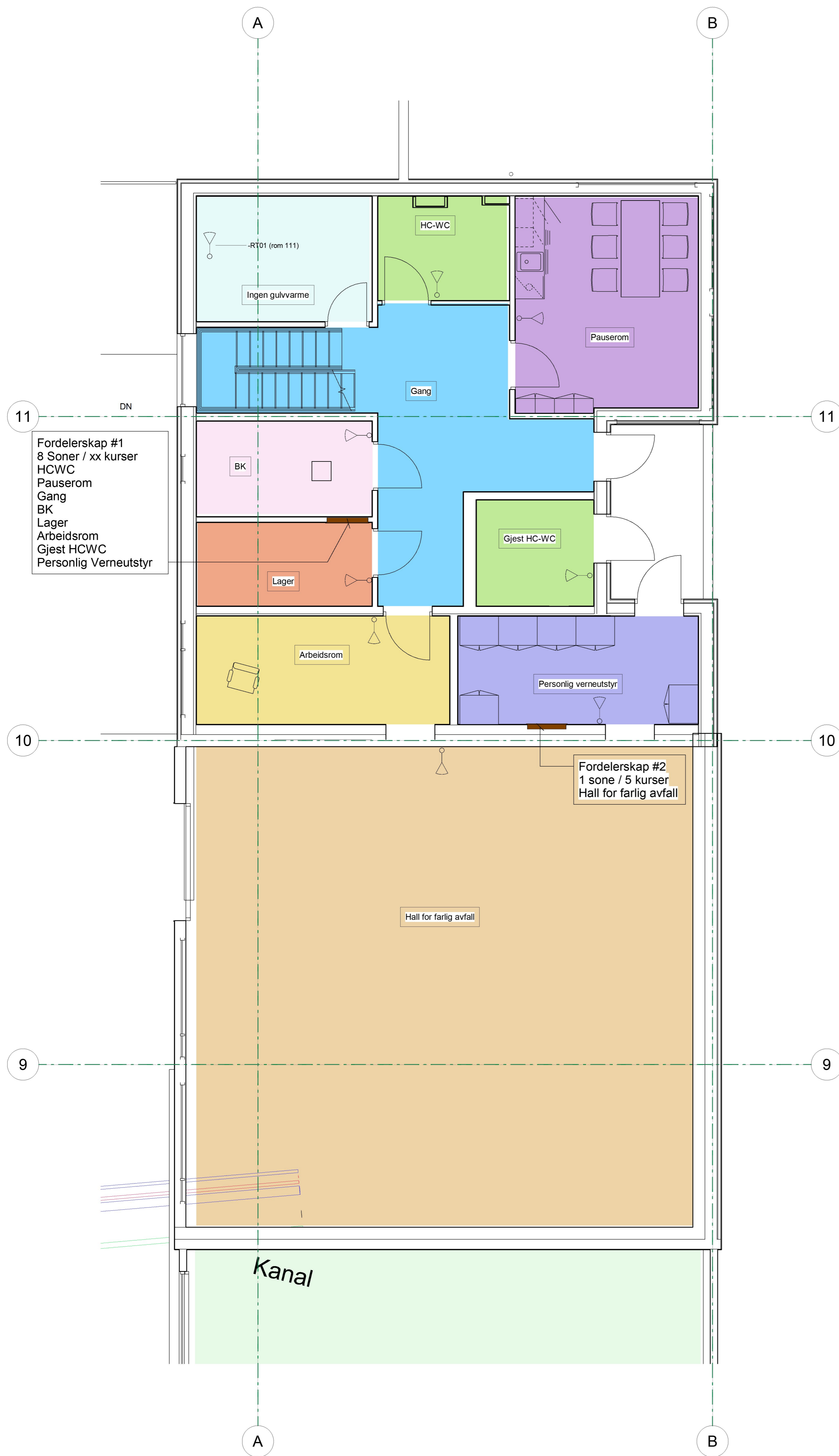

- Fordelerskap #1
- 8 Soner / xx kurser
- HCWC
- Pauserom
- Gang
- BK
- Lager
- Arbeidsrom
- Gjest HCWC
- Personlig Verneutstyr

Rev	Tilbudstegning Byggetrinn HEB	Tegn.	ED	SAL	09.02.23
		Kontr.	ED	SAL	04.04.22

Rev	Tilbudstegning Totalentreprise	Tegn.	ED	SAL	09.02.23
		Kontr.	ED	SAL	04.04.22
KARMØY KOMMUNE		Tegn.	ED	SAL	16.02.22
P56800 - NY GJENVINNGSSTASJON BORGAREDALEN		Målestokk:	1 : 50		
Gulvvarme Del 1		Status:	TILBUDSTEGNING		
		Prosj.nr	2321		
		Tegn.nr	V-20-00-32-01-2022		



Ferkingstad og Alsaker
 RÅDGIVENDE INGENIØRER VVS
 Karmundgt. 159 - 5522 Haugesund - Tlf 52 70 53 80



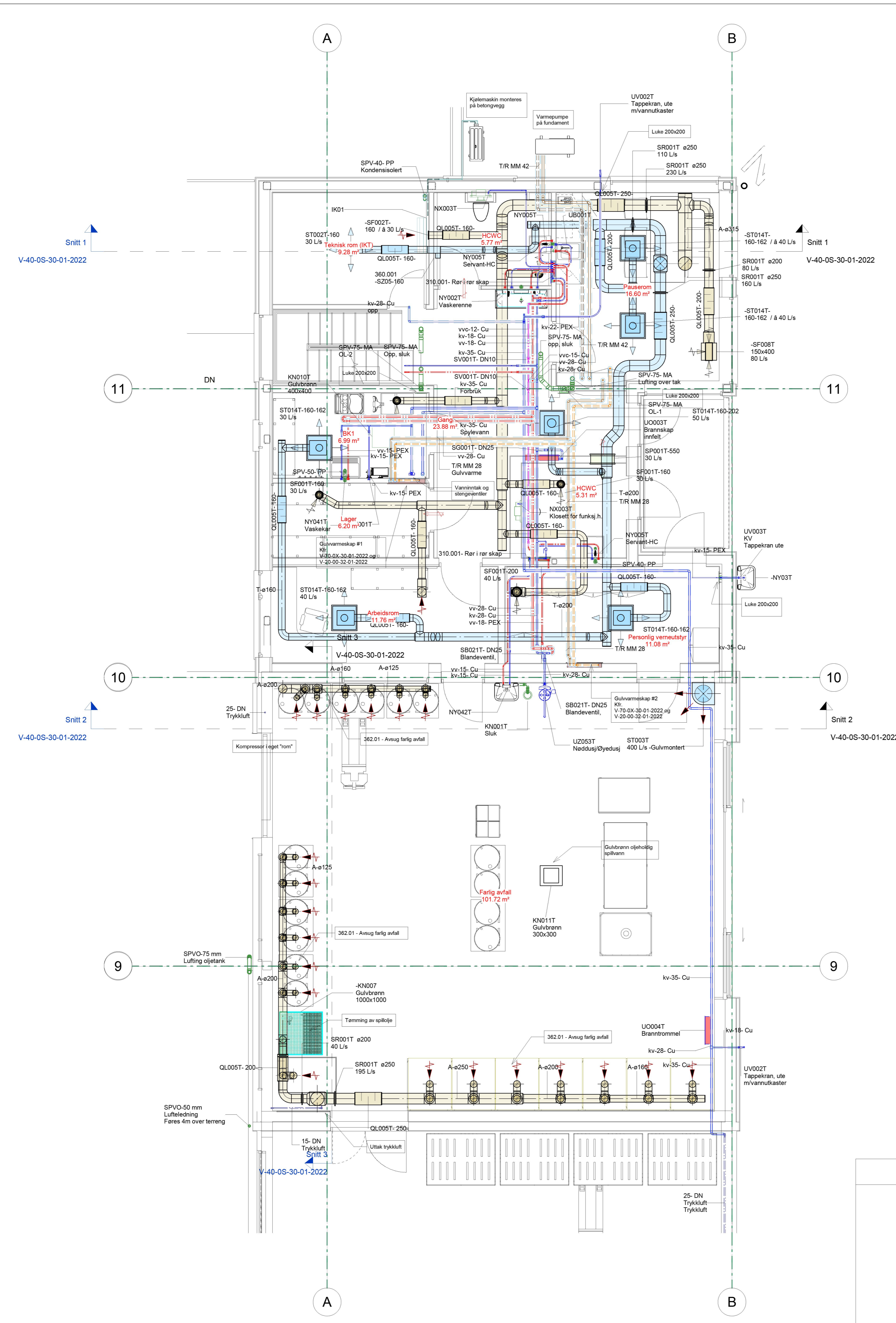

Tegn. nr	V-20-01-30-01-2022	Rev.	
Rev			
Tilbudstegning Totalentreprise	ED	SAL	09.02.23
Tilbudstegning Byggetrinn HEB	ED	SAL	04.04.22
KONTROL	TEGN.	KONTR.	DATO
KARMØY KOMMUNE	ED		
P56800 - NY GJENVINNINGSTASJON BORGAREDALEN	KONTR.	SAL	DATO 16.02.22
Plan 1.etg Del 1	Målestokk:		1 : 50
	Status:	TILBUDSTEGNING	
	Prosj nr	2321	
	Tegn. nr	V-20-01-30-01-2022	
	Rev.		

Tilbudstegning Totalentreprise		ED	SAL	09.02.23
Tilbudstegning Byggetrinn HEB		ED	SAL	04.04.22
Rev	Revideringen gjelder	Tegn.	Kontr.	Dato.
KARMØY KOMMUNE		ED		
P56800 - NY GJENVINNINGSTASJON BORGAREDALEN		KONTR.	SAL	DATO 16.02.22
Plan 1.etg Del 1		Målestokk:		1 : 50
		Status:	TILBUDSTEGNING	
		Prosj nr	2321	
		Tegn. nr	V-20-01-30-01-2022	
		Rev.		



Ferkingstad og Alsaker
RÅDGIVENDE INGENIØRER VVS
Karmsundgt. 159 - 5522 Haugesund - Tlf 52 70 53 80

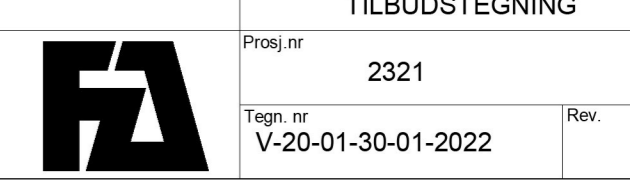

FCB/MAT: (254641)

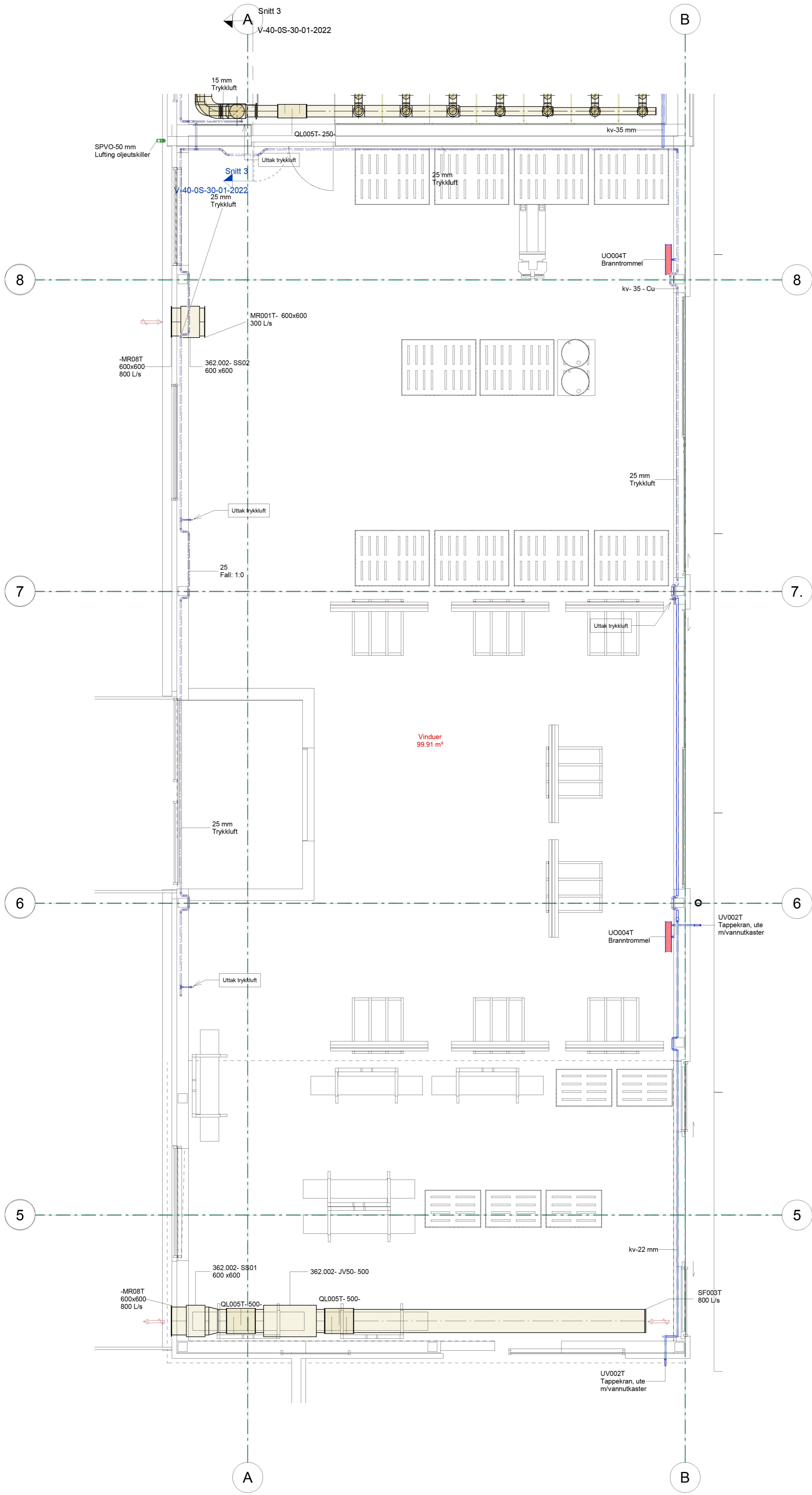

Rev	Tegn. nr	Rev.
	V-20-01-30-02-2022	

Tilbudstegning Totalentreprise		ED	SAL	09.02.23
Tilbudstegning Byggetrinn HEB		ED	SAL	04.04.22
Rev		Tegn.	Kontr.	Dato.
KARMØY KOMMUNE		TEGN	ED	DATO
P56800 - NY GJENVININGSSTASJON BORGAREDALEN		KONTR	SAL	DATO
Plan 1.etg Del 2		Målestokk:	1 : 50	
Status:		TILBUDSTEGNING		
Prosj nr		2321		
Tegn. nr		V-20-01-30-02-2022		
Rev.				



Ferkingstad og Alsaker
RÅDGIVENDE INGENIØRER VVS
Karmsundgt. 159 - 5522 Haugesund - Tlf 52 70 53 80



FORBILDE (52x64x1)

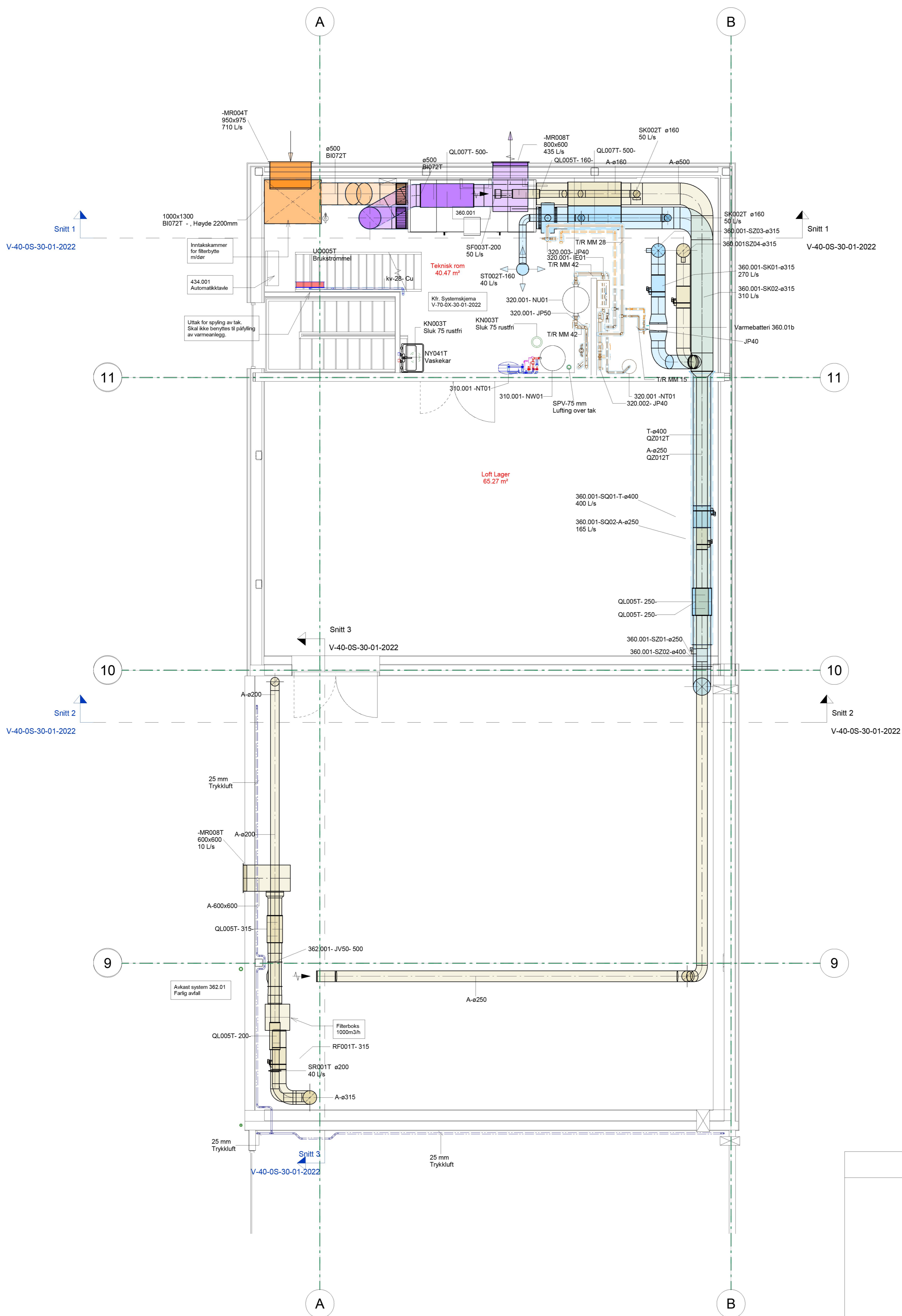

Tegn. nr	V-20-02-30-01-2022	Rev.	
----------	--------------------	------	--

Tilbudstegning Totalentreprise	ED	SAL	09.02.23
Tilbudstegning Byggetrinn HEB	ED	SAL	04.04.22
Rev	TEGN	KONTR	DATO
	ED	SAL	16.02.22
Målestokk:	1 : 50		
Status:	TILBUDSTEGNING		
Prosj nr	2321		
Tegn. nr	V-20-02-30-01-2022	Rev.	



Ferkingstad og Alsaker
RÅDGIVENDE INGENIØRER VVS
Karmsundgt. 159 - 5522 Haugesund - Tlf 52 70 53 80



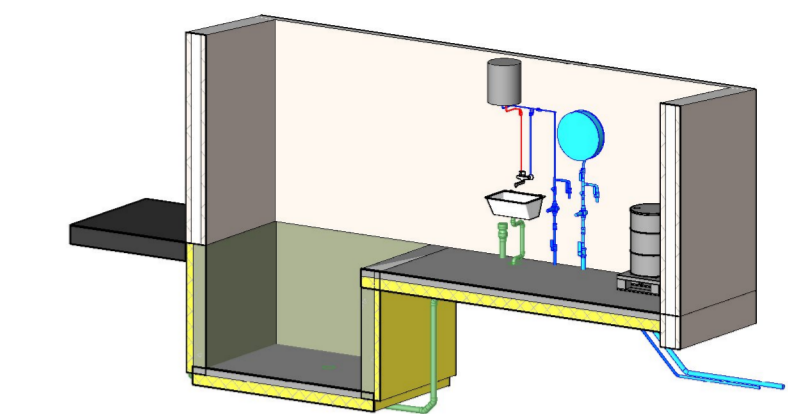
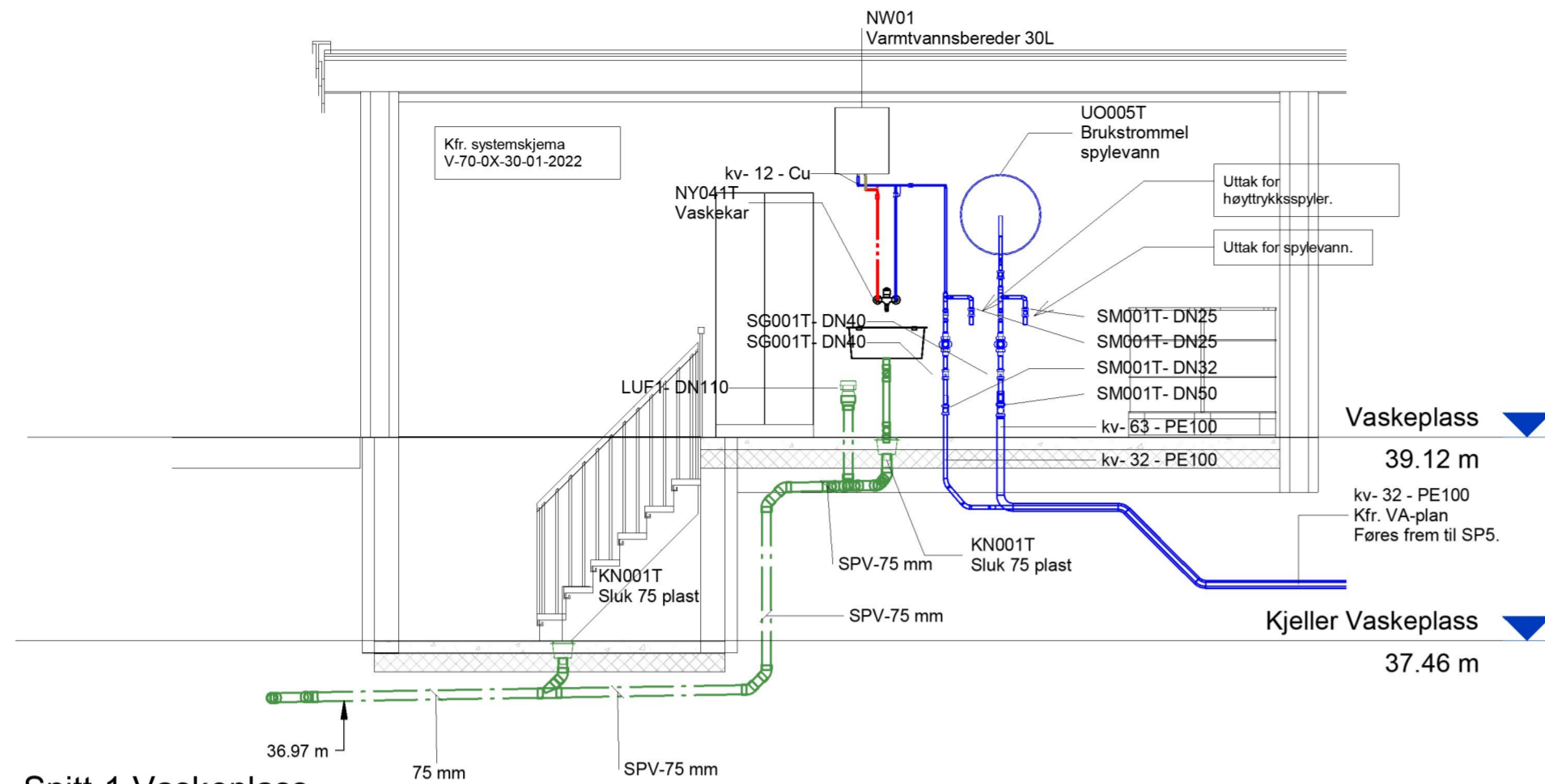

3 3D Vaskeclass

4 Snitt-1 Vaskeclass
1 : 50

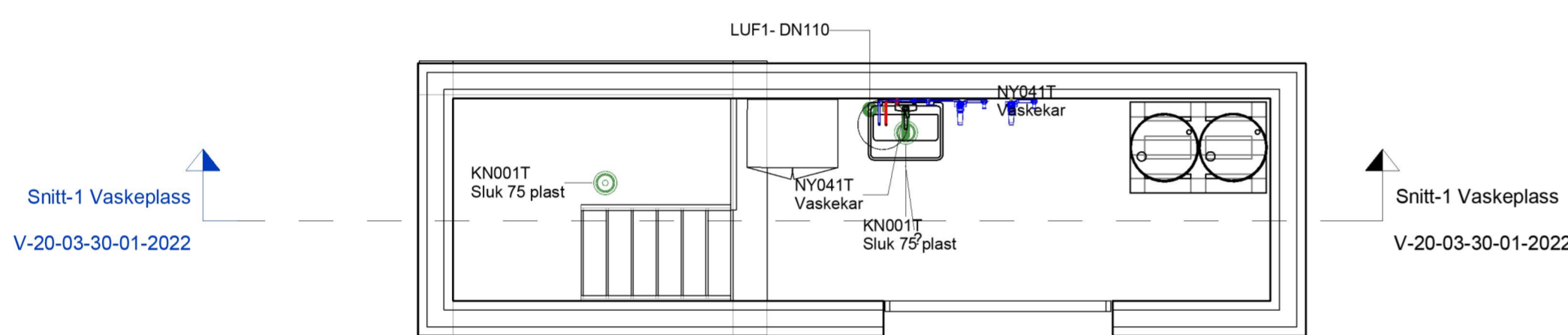

1 1.etg. Vaskeclass Utskrift
1 : 50

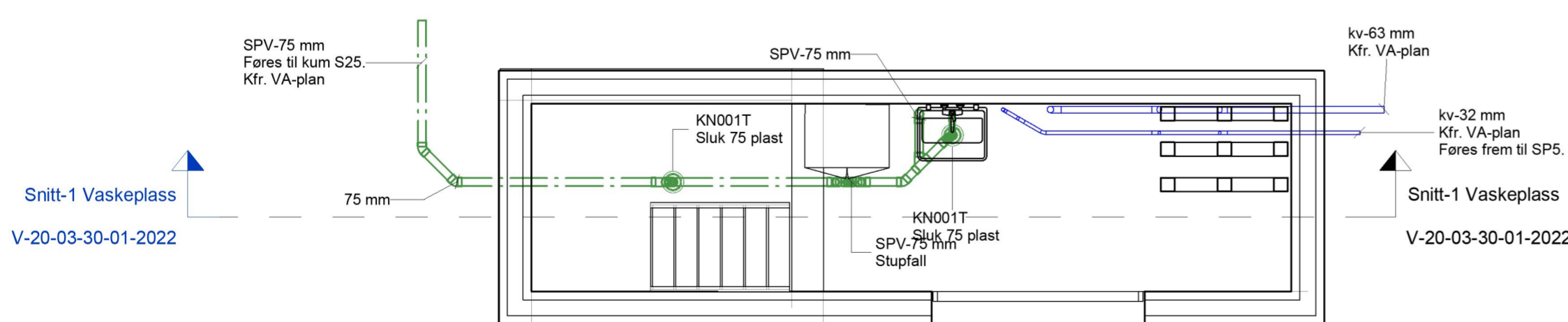

2 Bunnledninger Vaskeclass Utskrift
1 : 50

Tegn. nr	Rev.
V-20-03-30-01-2022	

Tilbudstegning Totalentreprise	ED	SAL	09.02.23
Tilbudstegning Byggetrinn HEB	ED	SAL	04.04.22
Rev	TEGN.	KONTR.	DATO
Revideringen gjelder	ED	SAL	16.02.22
KARMØY KOMMUNE			
P56800 - NY GJENVINNGSSTASJON BORGAREDALEN			
Plan og snitt Vaskeclass			
Målestokk:	1 : 50		
Status:	TILBUDSTEGNING		
Prosj.nr	2321		
Tegn. nr	V-20-03-30-01-2022		



Ferkingstad og Alsaker
RÅDGIVENDE INGENIØRER VVS
Karmsundgt.159 - 5522 Haugesund - Tlf 52 70 53 60



FORMAT: (694x420)

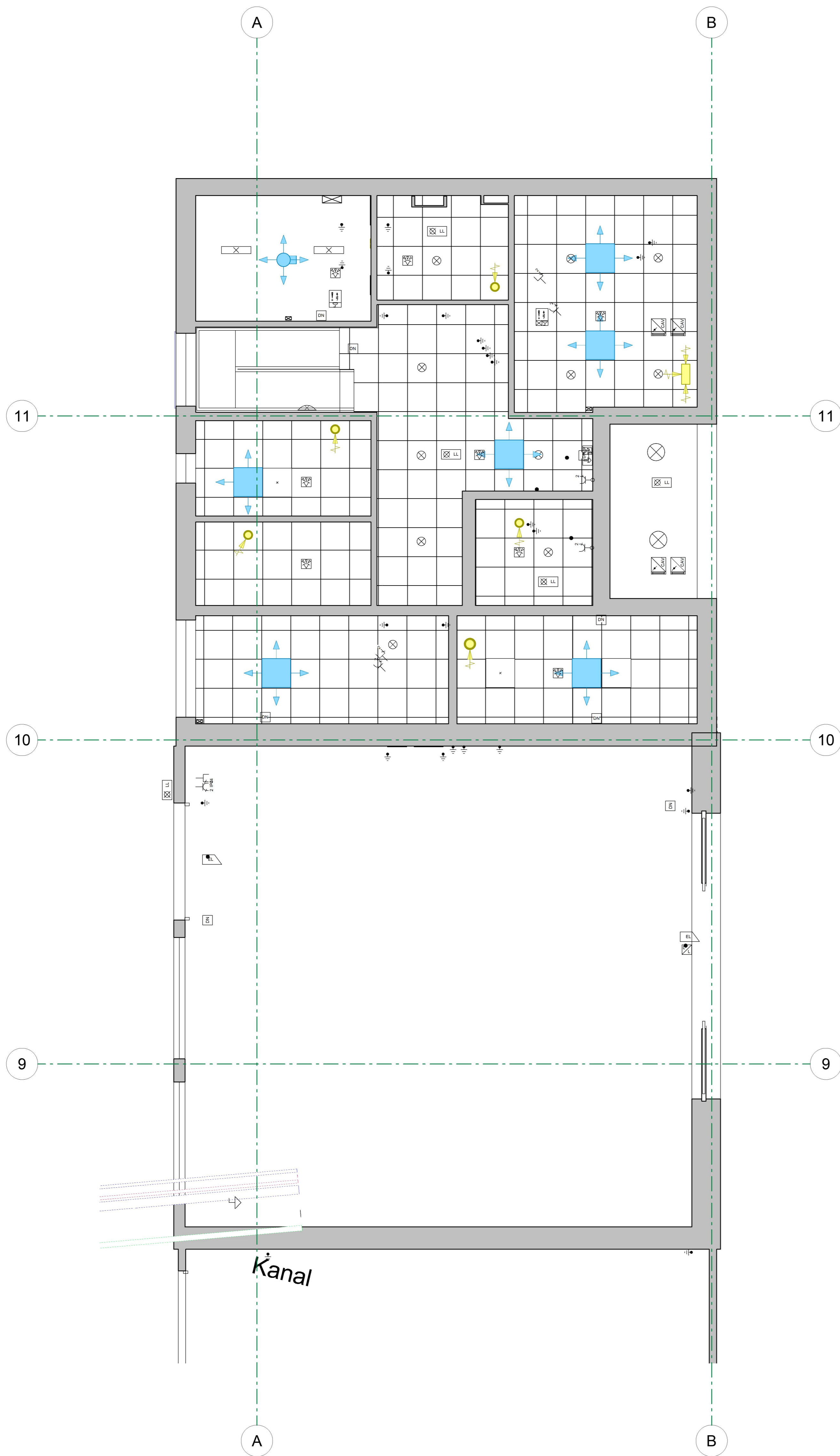

Rev	Tegn. nr	Rev.
	V-30-01-30-01-2022	

Tilbudstegning Totalentreprise		ED	SAL	09.02.23
Tilbudstegning Byggetrinn HEB		ED	SAL	04.04.22
Rev	Revideringen gjelder	Tegn.	Kontr.	Dato.
		ED		Dato.
KARMØY KOMMUNE		KONTR.	SAL	DATO
P56800 - NY GJENVINNGSSTASJON BORGAREDALEN				16.02.22
Himlingsplan 1.etg Del 1		Målestokk:	1 : 50	
		Status:	TILBUDSTEGNING	
		Prosj. nr	2321	
		Tegn. nr	V-30-01-30-01-2022	
		Rev.		



Ferkingstad og Alsaker
RÅDGIVENDE INGENIØRER VVS
Karmsundgt. 159 - 5522 Haugesund - Tlf 52 70 53 80



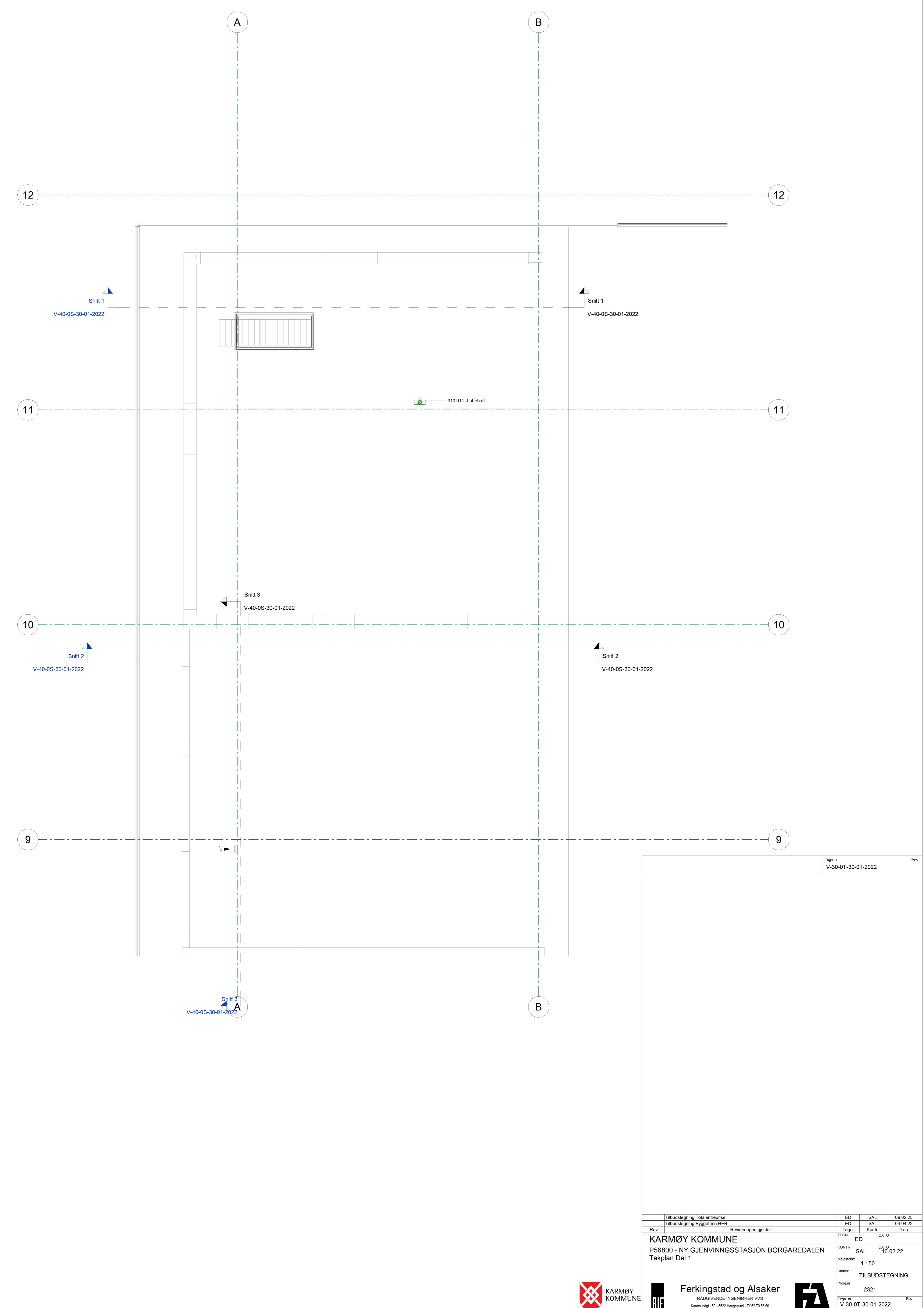

Tegn. nr	V-30-OT-30-01-2022	Rev.
----------	--------------------	------

Tilbudstegning Totalentreprise	ED	SAL	09.02.23
Tilbudstegning Byggetrinn HEB	ED	SAL	04.04.22
Rev	Revideringen gjelder	Tegn.	Kontr.
KARMØY KOMMUNE		TEGN	ED
P56800 - NY GJENVININGSSTASJON BORGAREDALEN		KONTR	SAL
Takplan Del 1		DATO	16.02.22
Målestokk:	1 : 50	Status:	TILBUDSTEGNING
Prosj nr	2321	Tegn. nr	V-30-OT-30-01-2022
Rev.		Rev.	



Ferkingstad og Alsaker
RÅDGIVENDE INGENIØRER VVS
Karmsundgt. 159 - 5522 Haugesund - Tlf 52 70 53 80



FCB/MT: (564641)

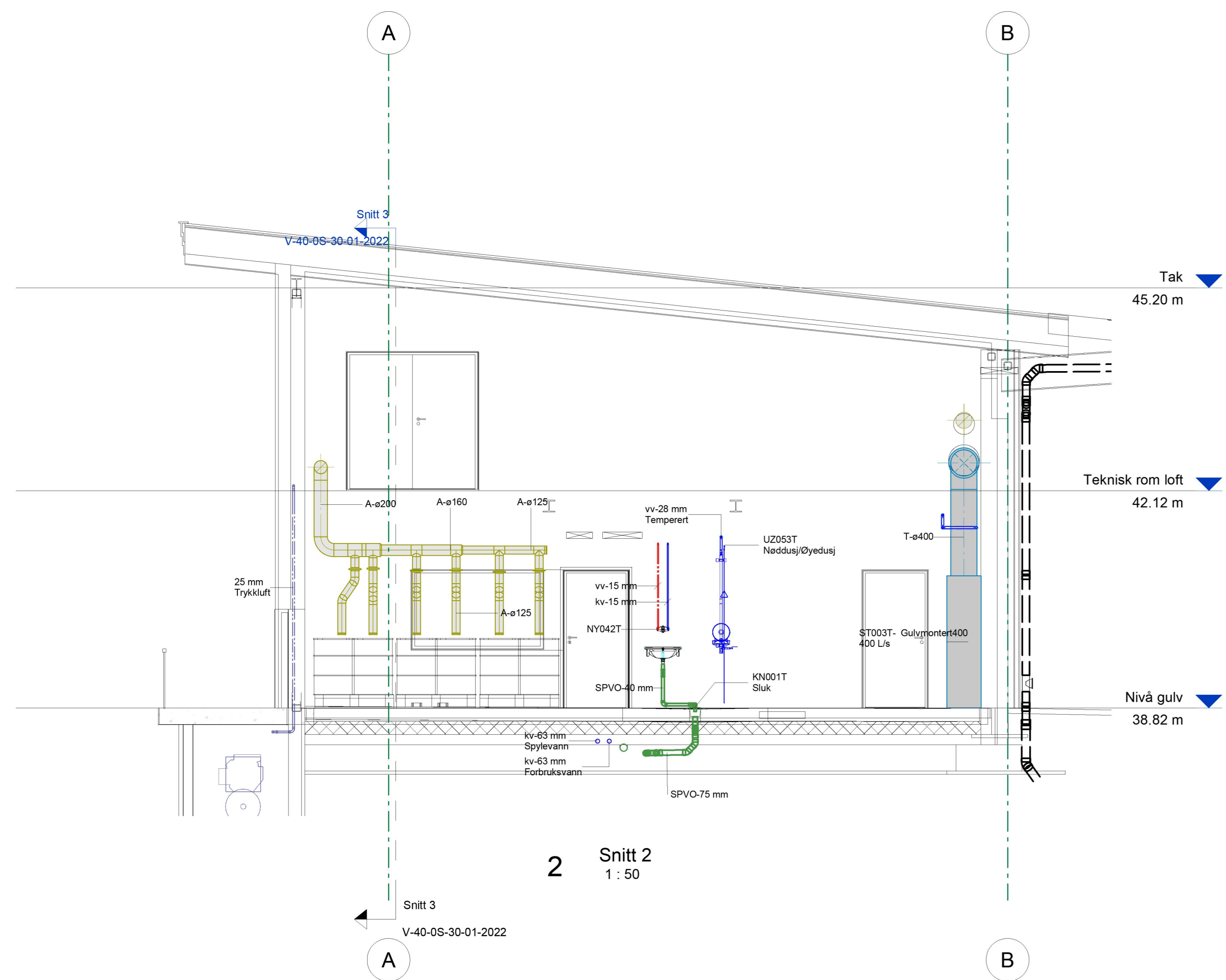

2 Snitt 2
1 : 50

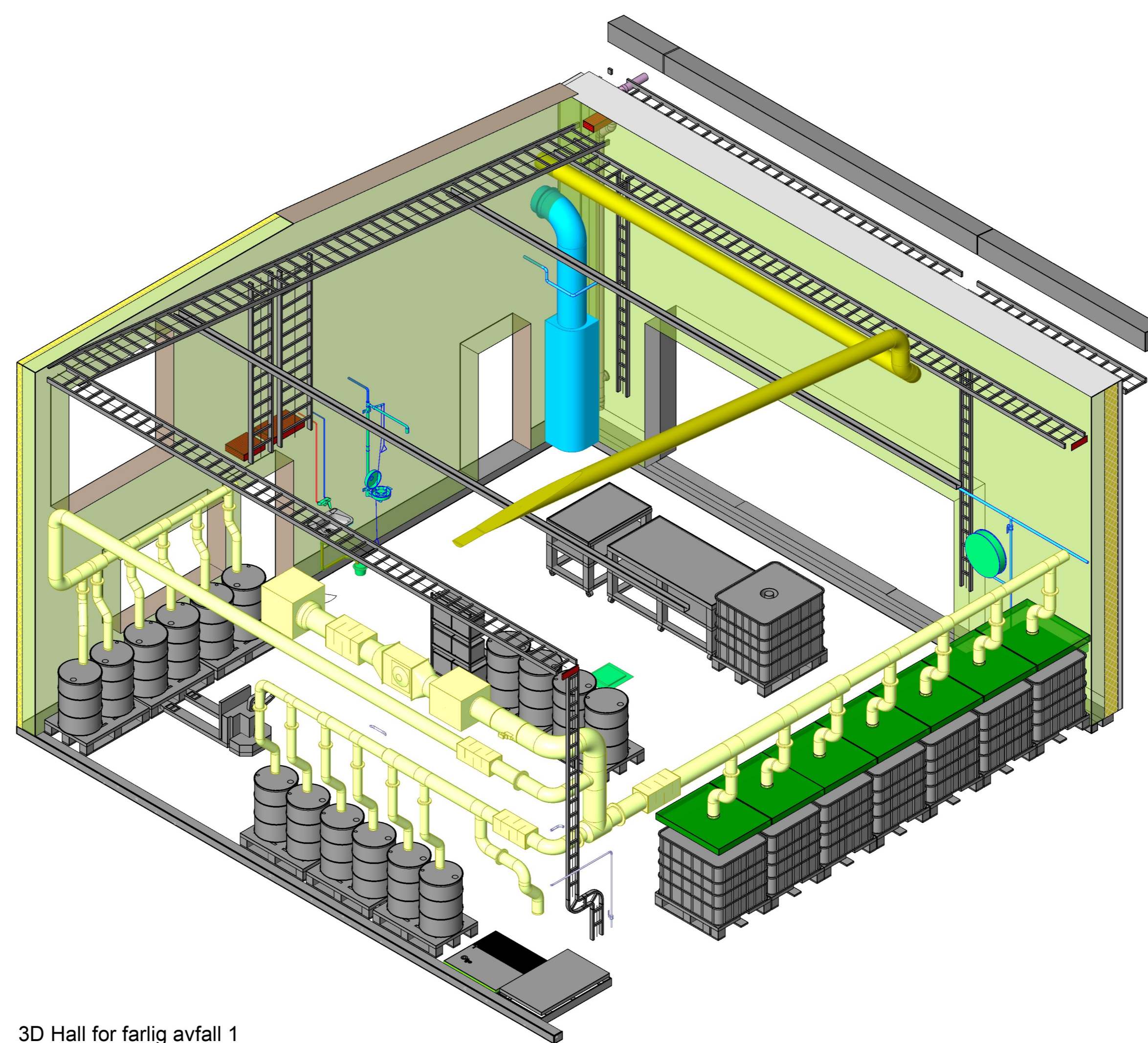

4 3D Hall for farlig avfall 1

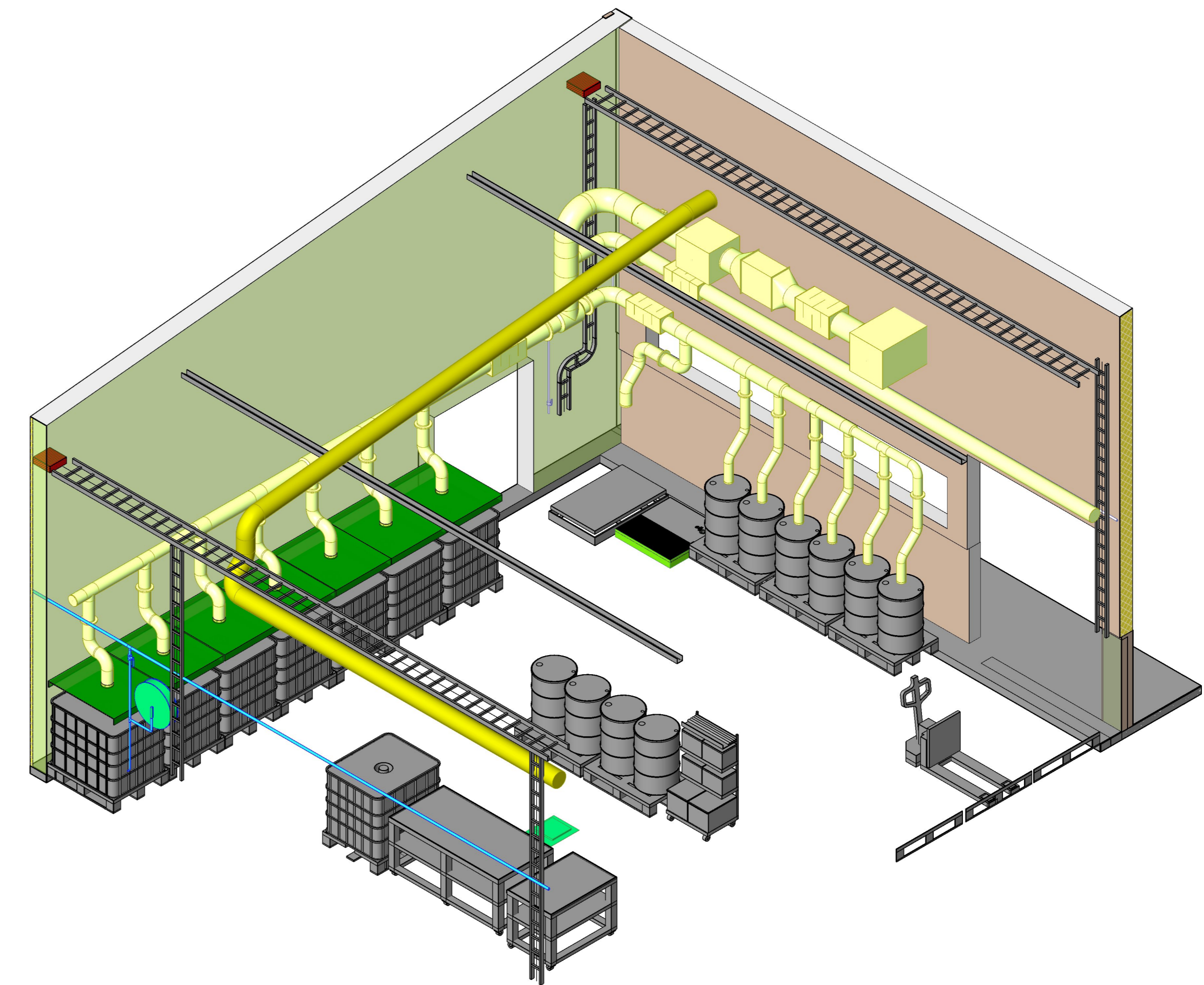

6 3D Hall for farlig avfall 2

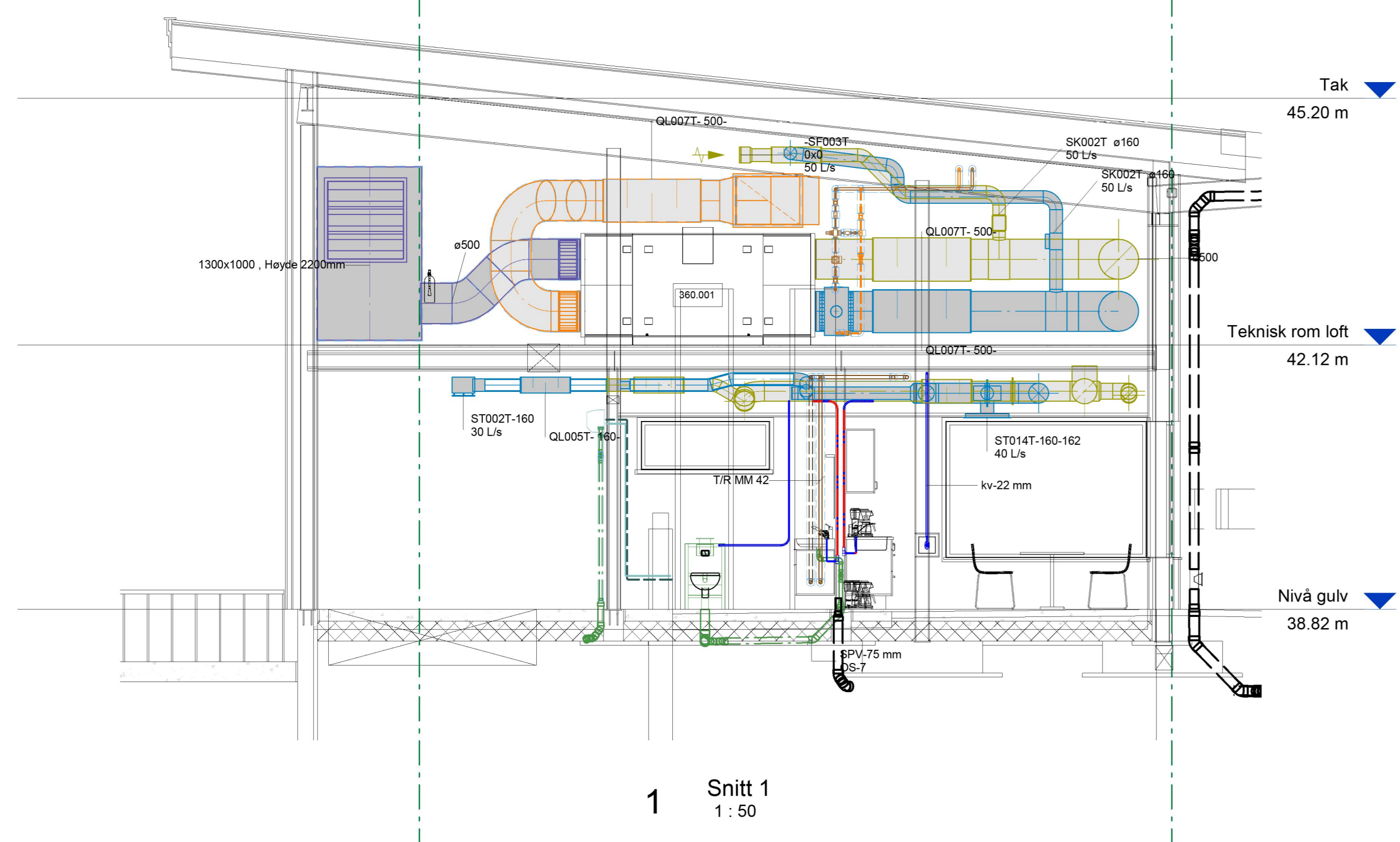

1 Snitt 1
1 : 50

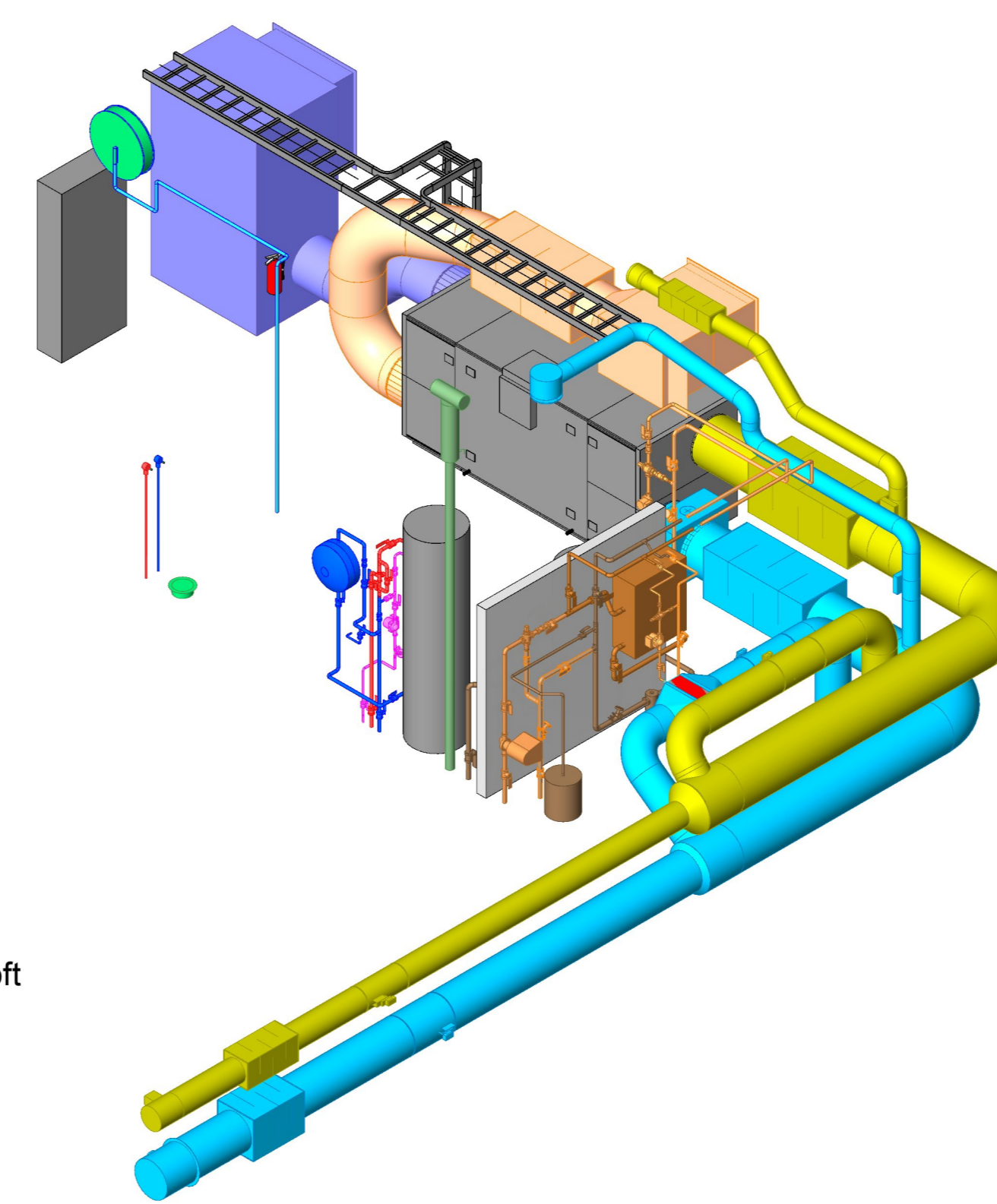

5 Teknisk rom loft

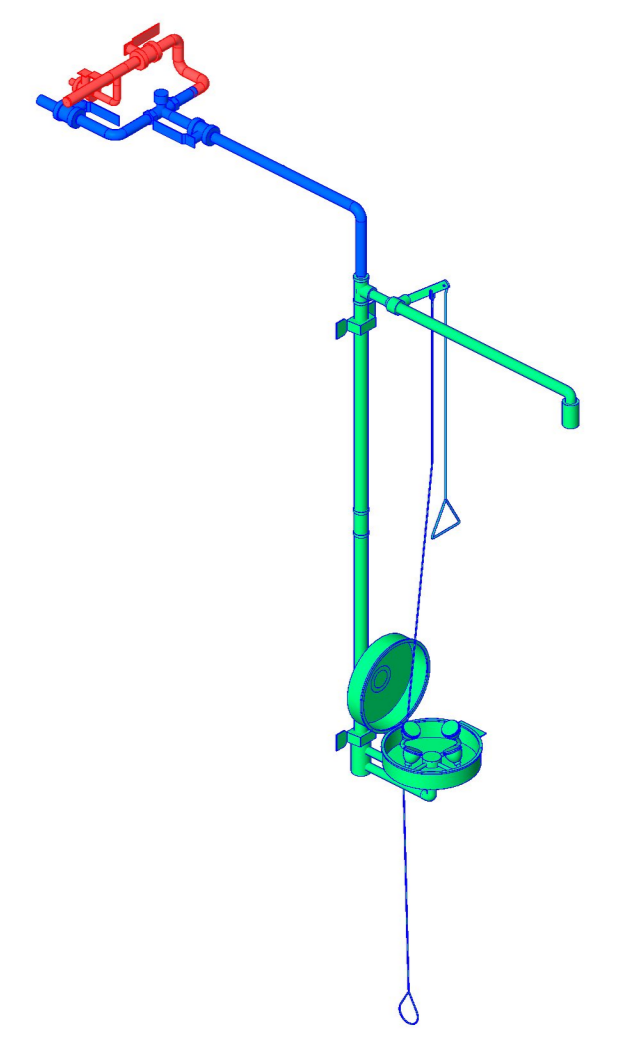

3 3D Nød og Øyedusj

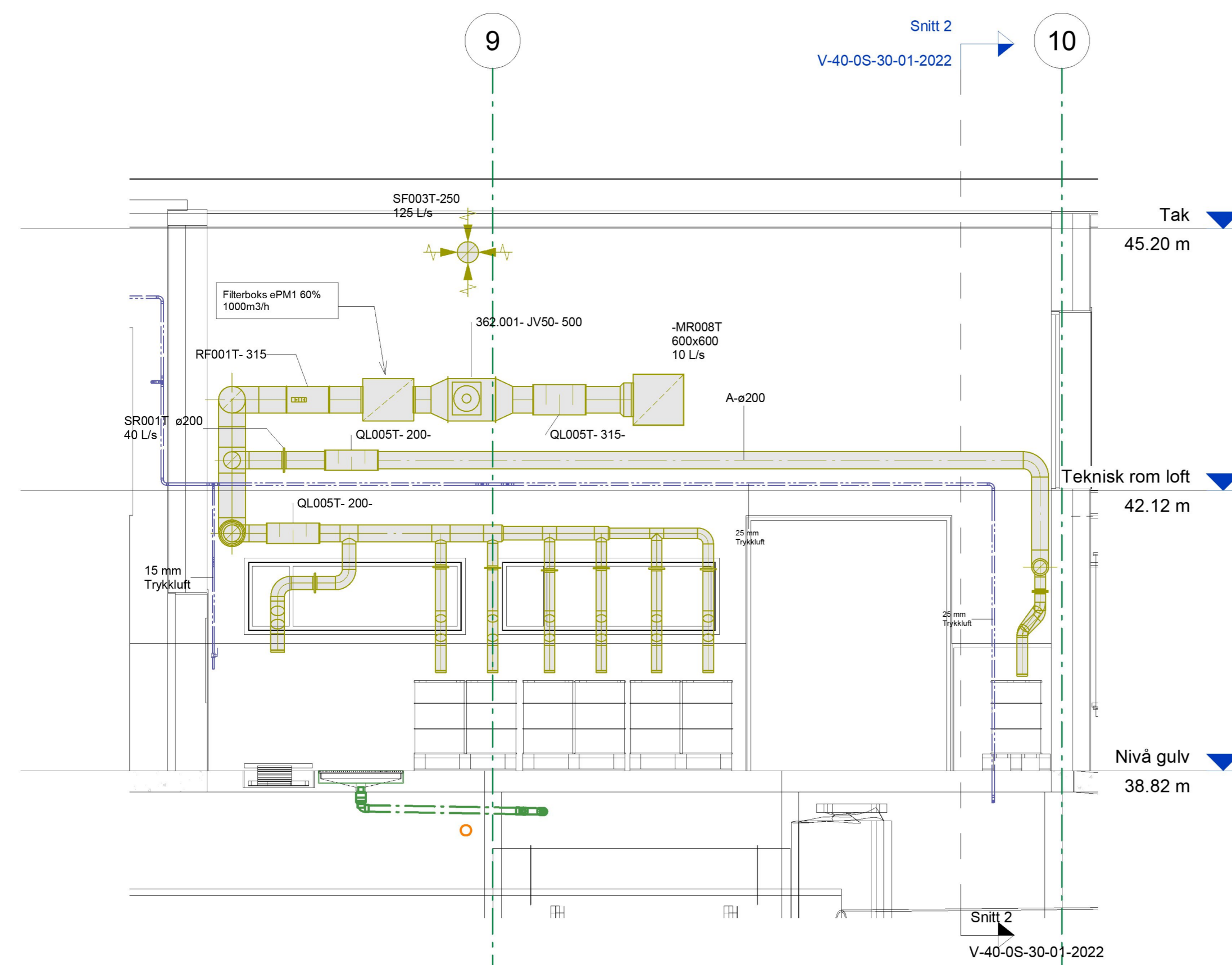

7 Snitt 3
1 : 50

Tilbudstegnning Totalentreprise		ED	SAL	09.02.23
Tilbudstegnning Ergonomi HSB		ED	SAL	04.04.22
Rev	Revideringen gjelder	Tegn	Kont	Dato
		ED	SAL	15.02.22
		SAL	SAL	16.02.22
Målestokk: 1 : 50		Status: TIL GJENNOMSYN		
Prosjekt nr: 2321		Rev:		
Oppdragsnr: V-40-05-30-01-2022		Rev:		

System 310.12
Oljeholdig spillvann / spillolje

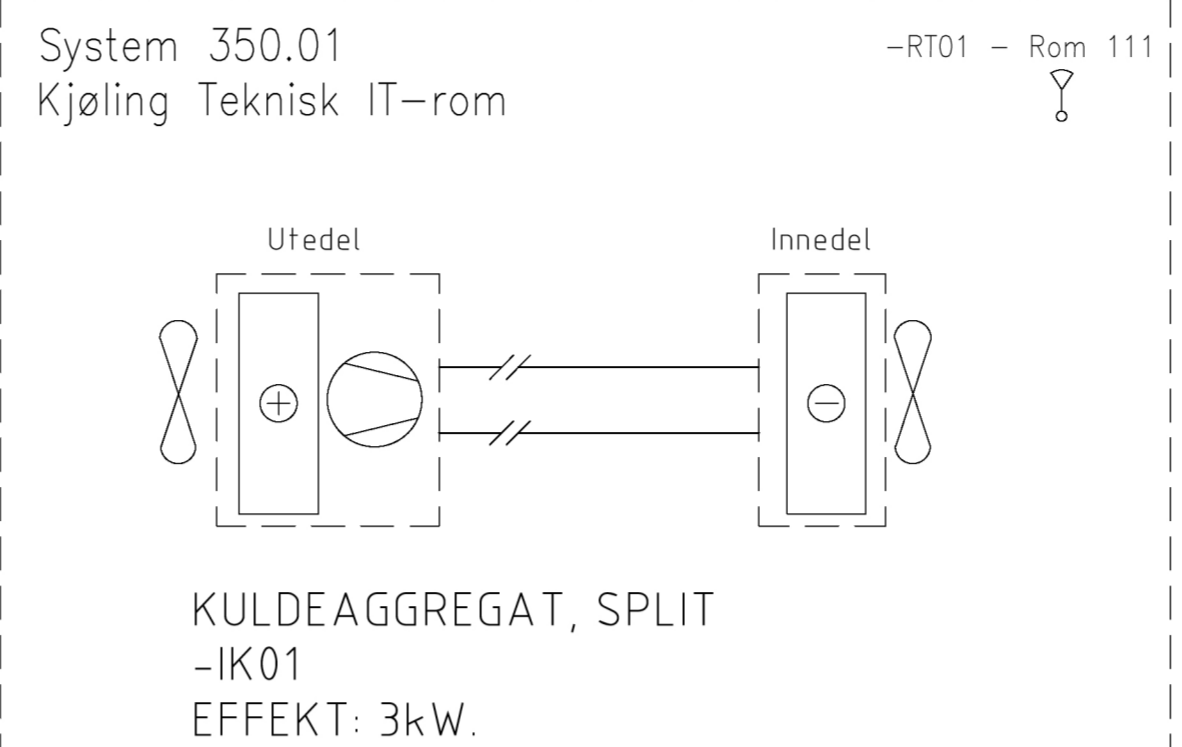
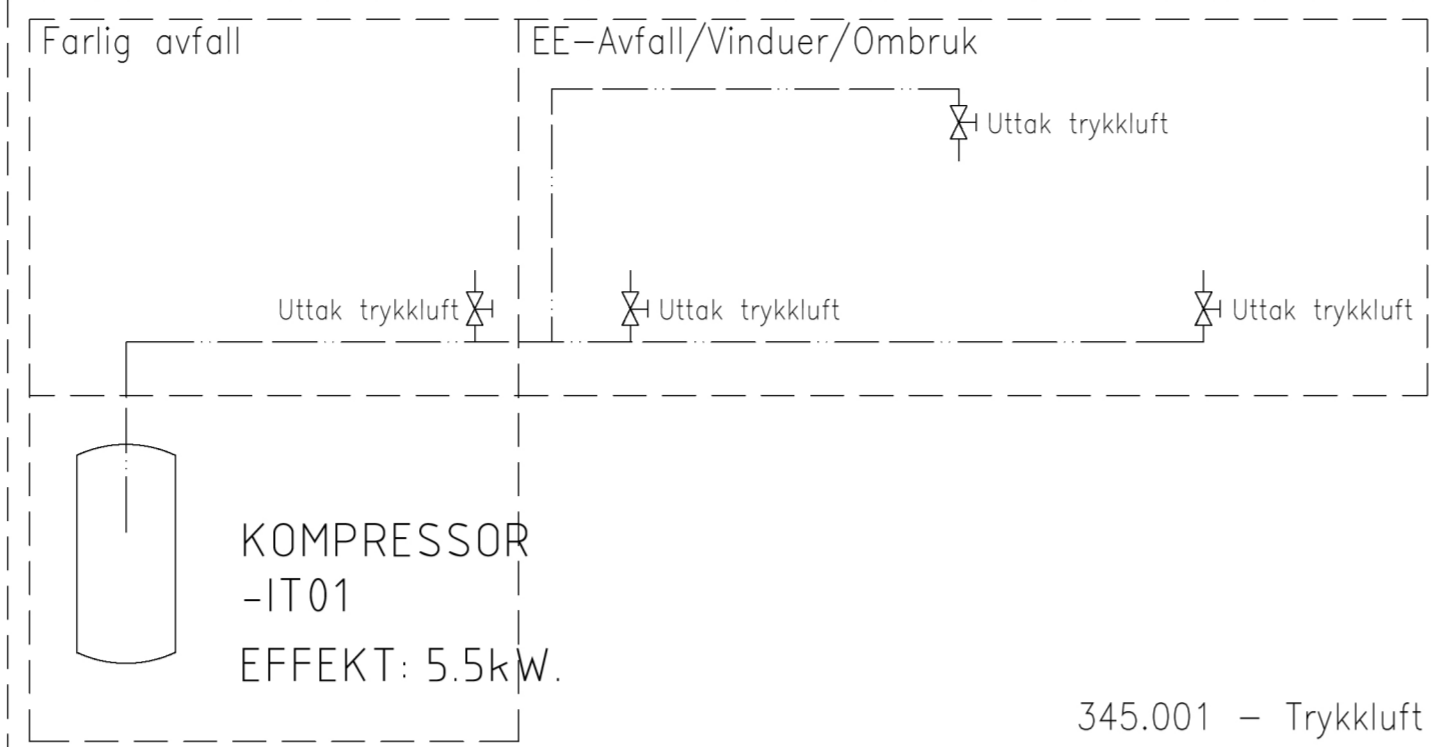
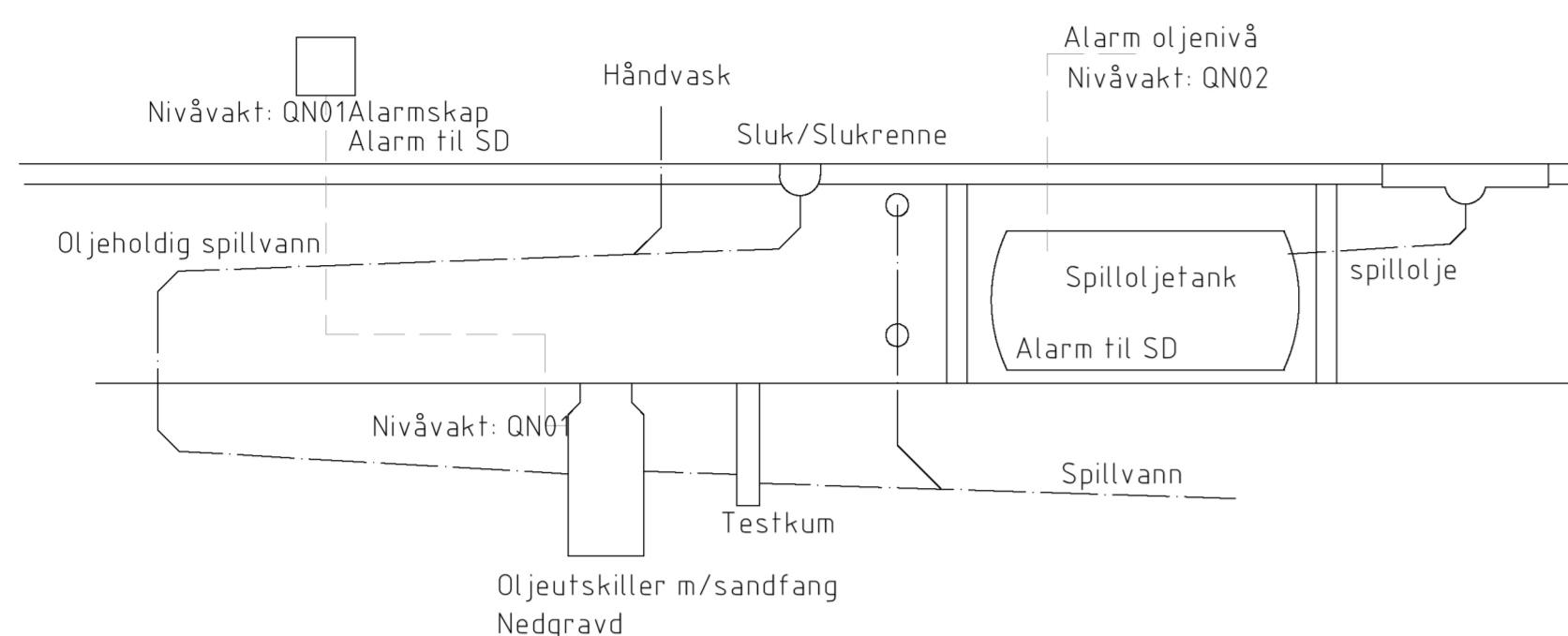

System 310.01
Forbruksvann

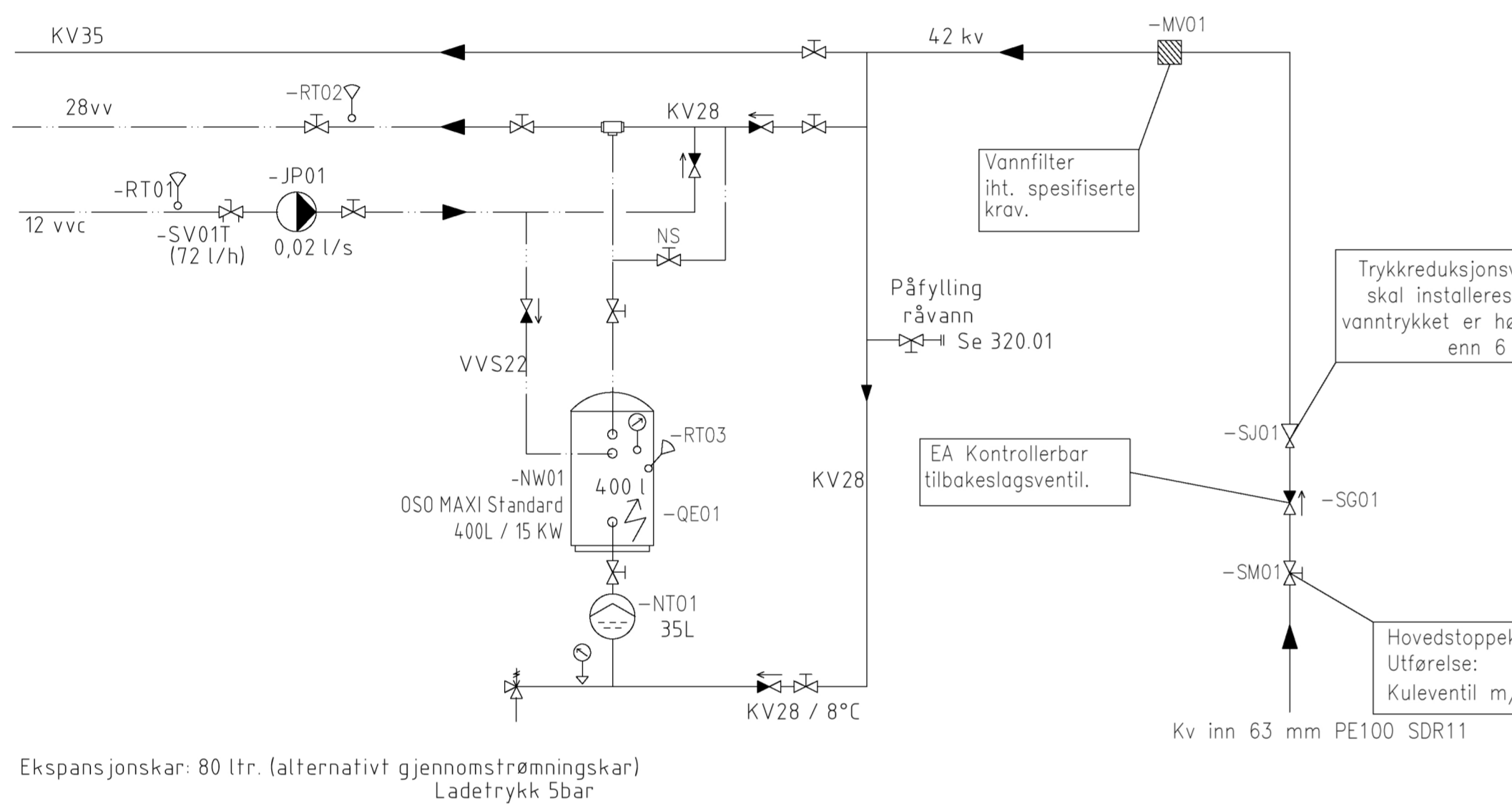

System 310.02
Spylevann/Prosessvann
Kontorbygg/Lagerheller

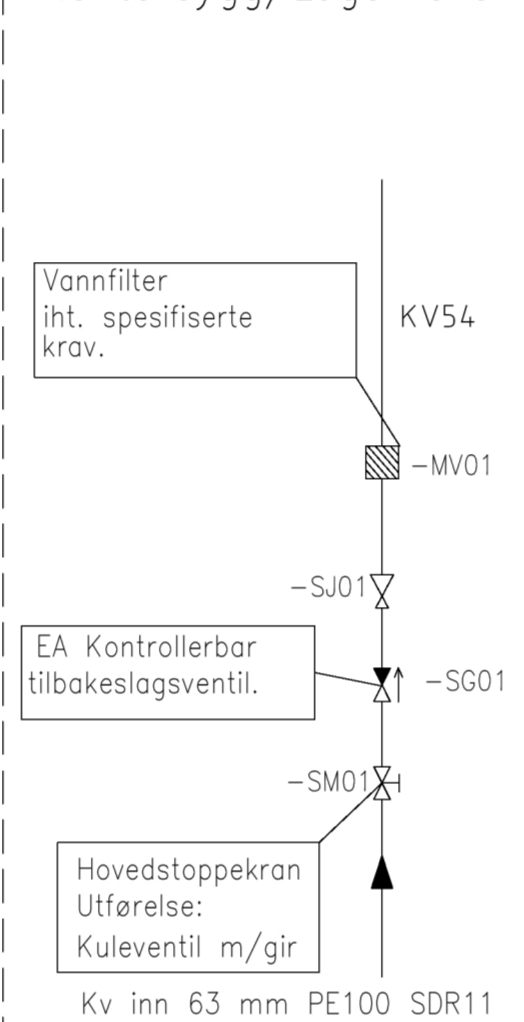

System 320.02
Gulvvarme
7 kW

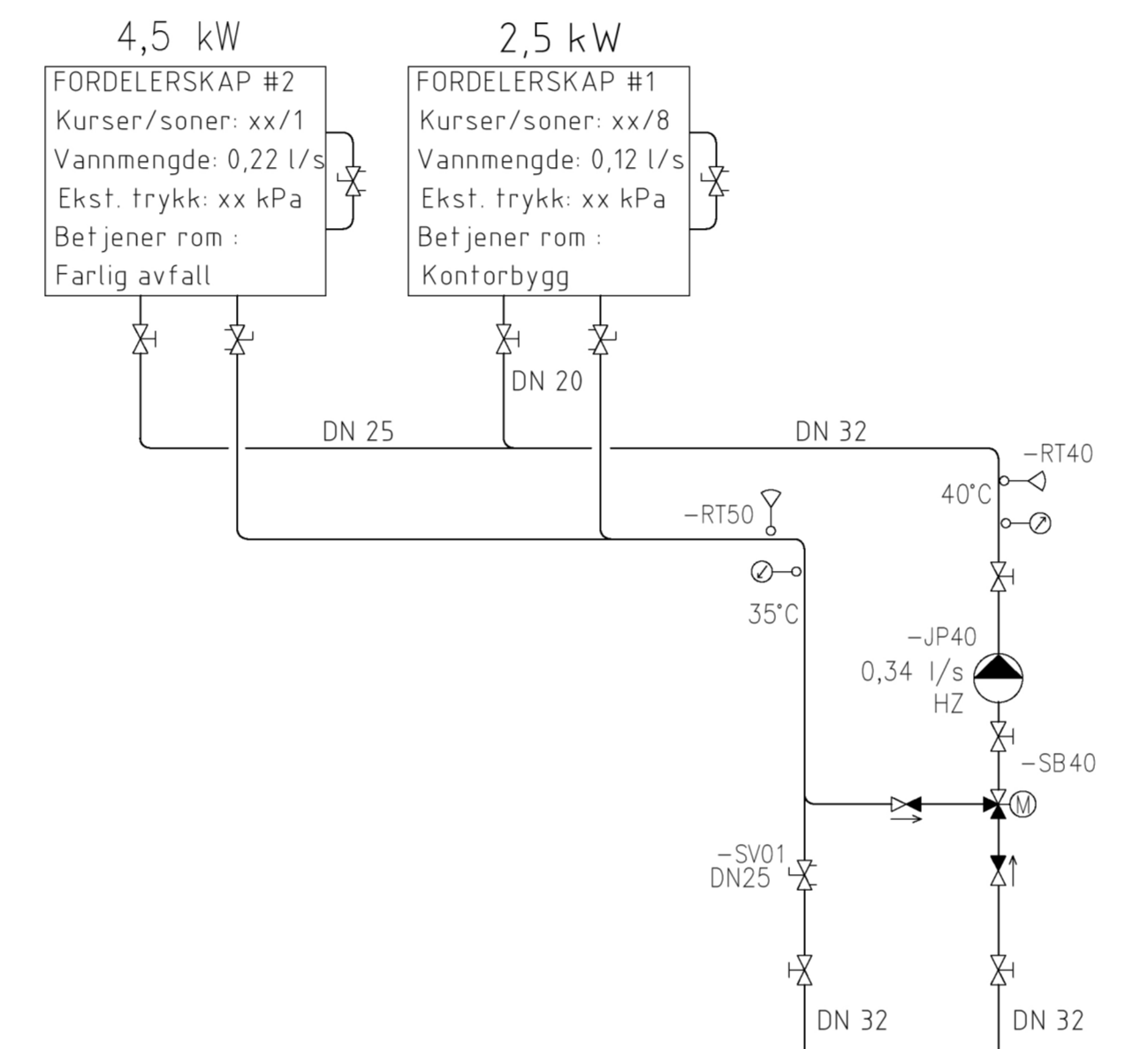

System 360.01a
Ventilasjonkurs
17 kW
Tilluft: 2600 m³/h
Avtrekk: 1600 m³/h
heve fra DUT til 16°C

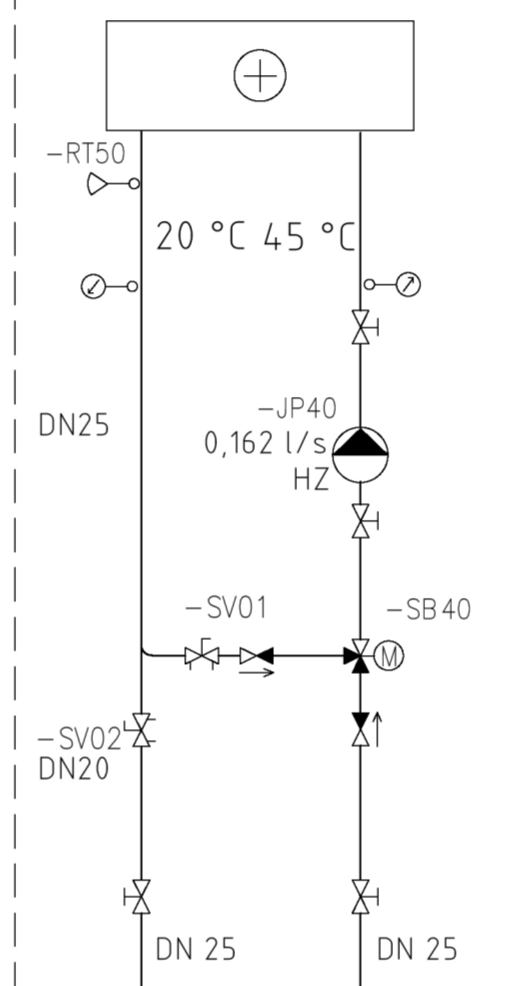

System 360.01b
Ventilasjonkurs
2,7 kW
Tilluft: 1000 m³/h
Avtrekk: 1000 m³/h
heve fra 16 til 21°C

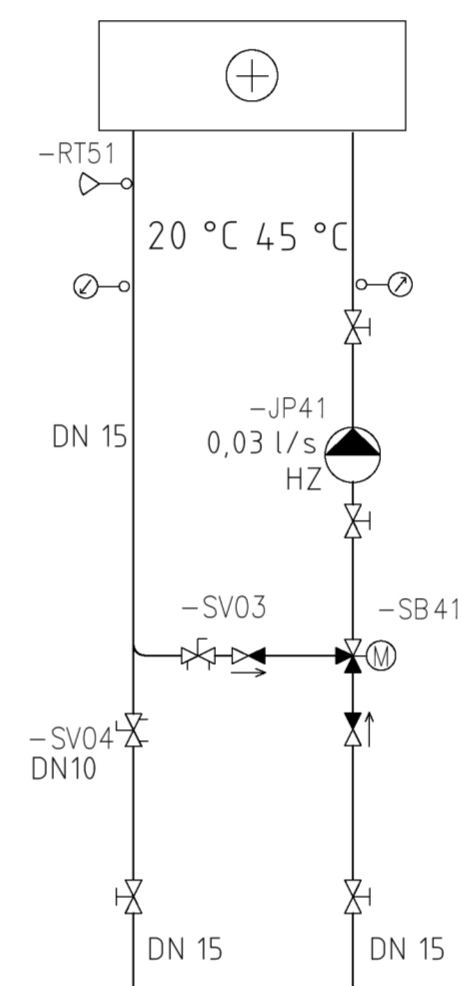

System 310.03
Spylevann/Prosessvann
Vaskeplass

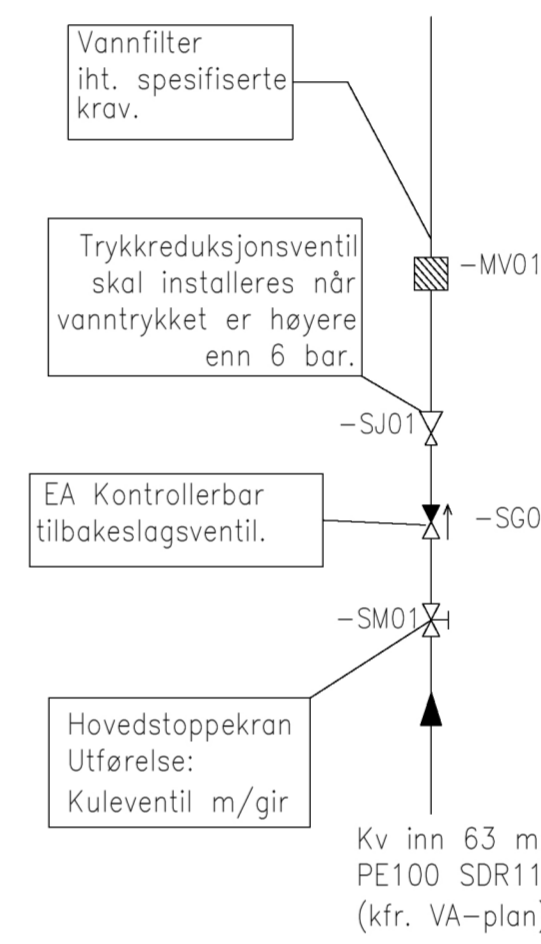

System 320.01
Varmesentral

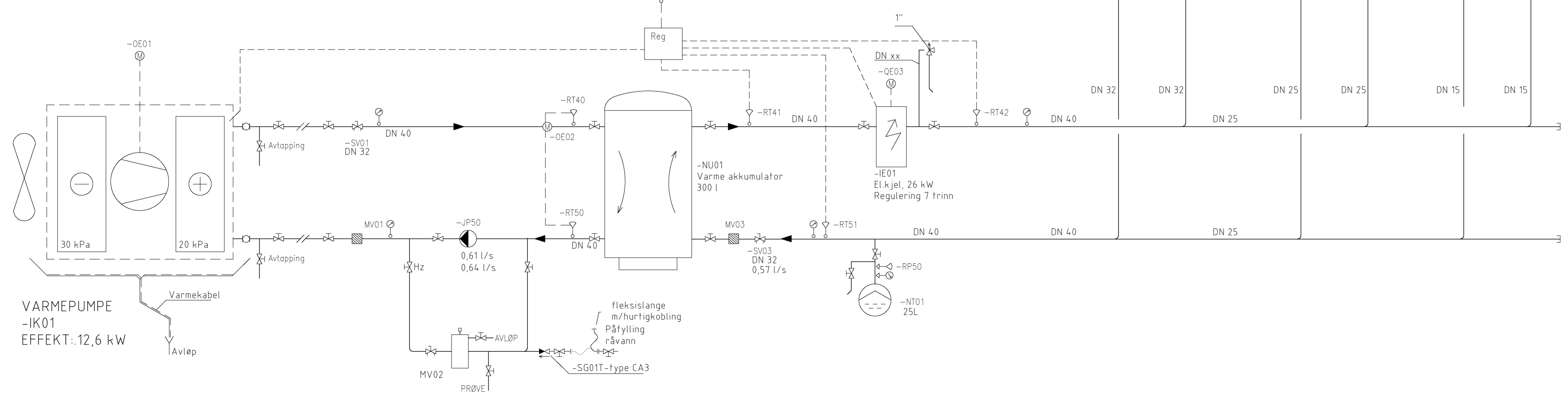

System 310.04
Forbruksvann
Vaskeplass

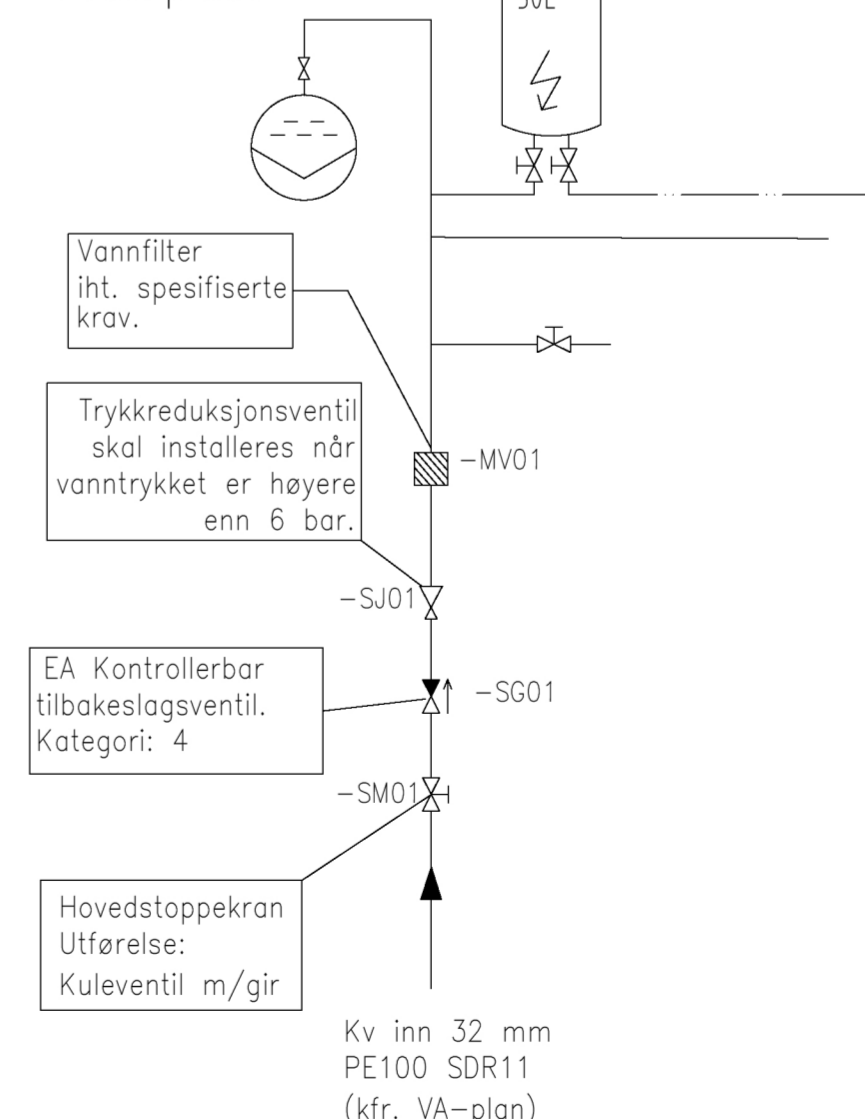

<ul style="list-style-type: none"> Avstengingsventil 2-veisventil, modulerende Trykkavhengig 2-veisventil, Åpav/steng Trykkreduksjonsventil Tilbakeslagsventil Reguleringsventil m/målestak Trykkuhengig ventil Sikkerhetsventil 3-veisventil, modulerende Filter Kondenspolette Vakuumventil Microbølgefilter Kompensator (CO) Fastpunkt Styring Plugg Bindlens Pumpe Tvillingpumpe 	<ul style="list-style-type: none"> Temperaturmåler (Termometer) Temperaturgiver Termostal Trykkmåler (Manometer) Trykkgiver Pressostat Mengdemåler Mengdegiver Strømslaggiver Hastighetsgiver Fukighetsmåler Fukighetsgiver Hygrosstat Entslogiver Motor, modulerende Motor, av/på Filtervakt CO2-filter Buskommunikasjon Energimåler (fleksibel) Temperaturgiver på tur og retur Energimåler (elektrisk) Ekspansjonskar Kjøli for fast Brensel 	<ul style="list-style-type: none"> Gassfyr kjel Djøfyr kjel Elektrisk Akkumulatortank VVB - vambrent oppvarmet VVB el. oppvarmet Varmevæskel
--	--	---

Tegning nr. **V-70-0X-30-01-2022-Energianlegg**

TILBUDSTEGNING TOTALENTPREISE	ED	09.02.23
TILBUDSTEGNING	ED	04.04.22
REV. TEKST	SIGN	DATE
KARMØY KOMMUNE	TEGN	ED
P56800 - NY GJENVINNINGSTASJON BORGAREDALEN	KONTR. SAL	DATE
SYSTEMSKJEMA ENERGIANLEGG	REVISJON	DATE
TRYKKLUFT, KJØLING, FORBRUKSVANN OG OLJEHOLDIG SPILLVANN	Prosjekt	2321
Ferkingstad og Alsaker	RÅDGIVENDE INGENIØRER VVS	Rev.
Karmøysgt 58 - 5522 Haugesund - Tlf 52 70 53 60 - Fax 52 70 53 66	V-70-0X-30-01-2022	

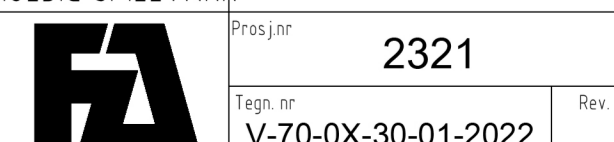

SYSTEM +=360.01
KONTORBYGG

Nattdrift
Tilluft = + 440 L/s (15°C)
Avtrekk = - 165 L/s (15°C)

Dagdrift
Tilluft = + 440 L/s (15°C) + 270 L/s (21°C)
Avtrekk = - 435 L/s, Samlet avtrekk (17,5°C)

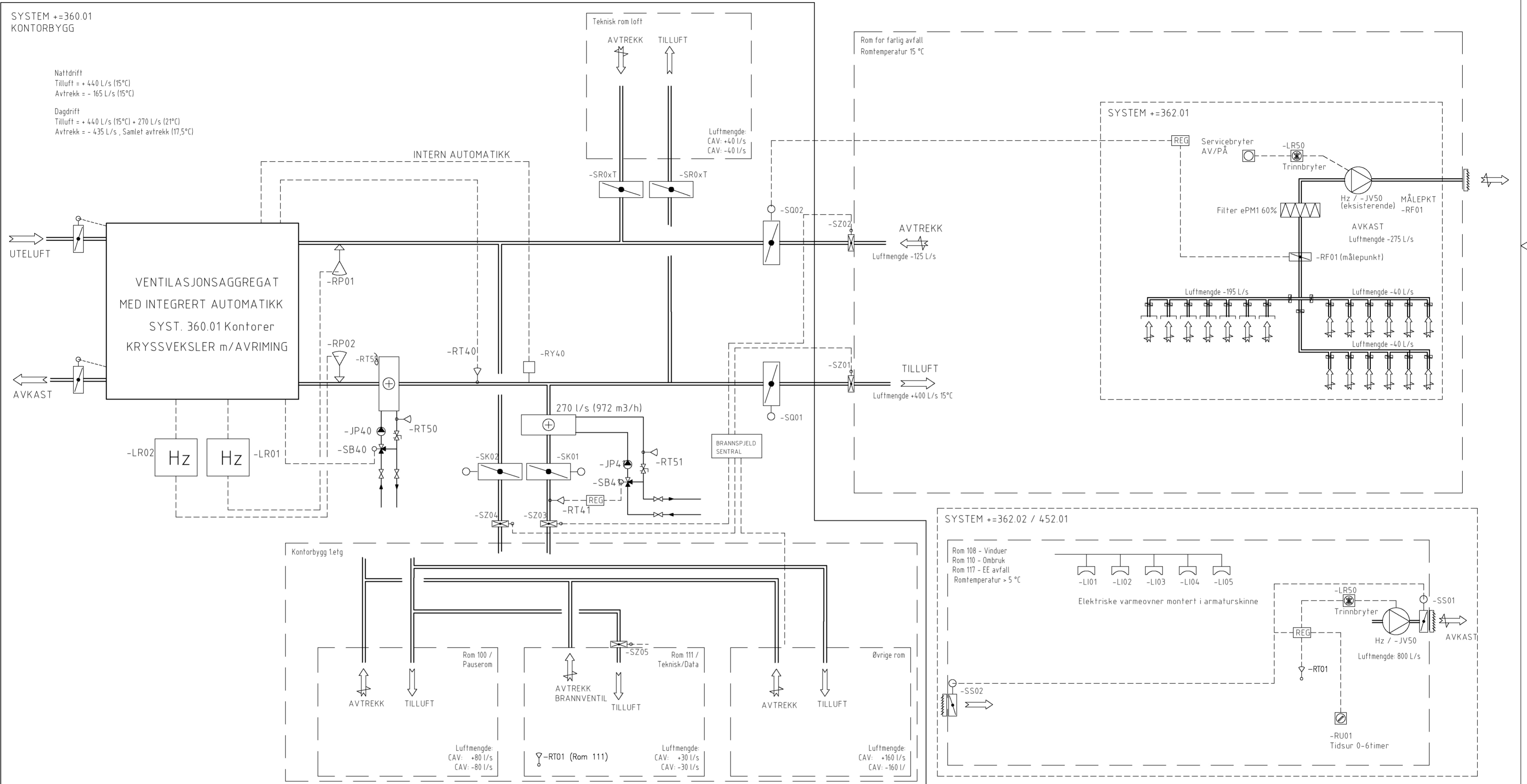

	TILBUDSTEGNING TOTALENTREPRISE	ED	09.02.23
	TILBUDSTEGNING	ED	04.04.22
REV.	TEKST	SIGN.	DATO
	KARMØY KOMMUNE	TEGN.	ED
	P56800 - NY GJENVINNGSSTASJON BORGAREDALEN	DATO	06.09.21
	SYSTEMSKJEMA VENTILASJONSANLEGG 360.01 / 362.01 / 362.02	KONTR.	SAL
		DATO	16.02.22
		GODKJ.	DATO
		Målestokk:	-
		Prosj.nr	2321
		Tegn. nr	V-70-0X-30-02-2022
		Rev.	

