

BYA = 15,8 m²

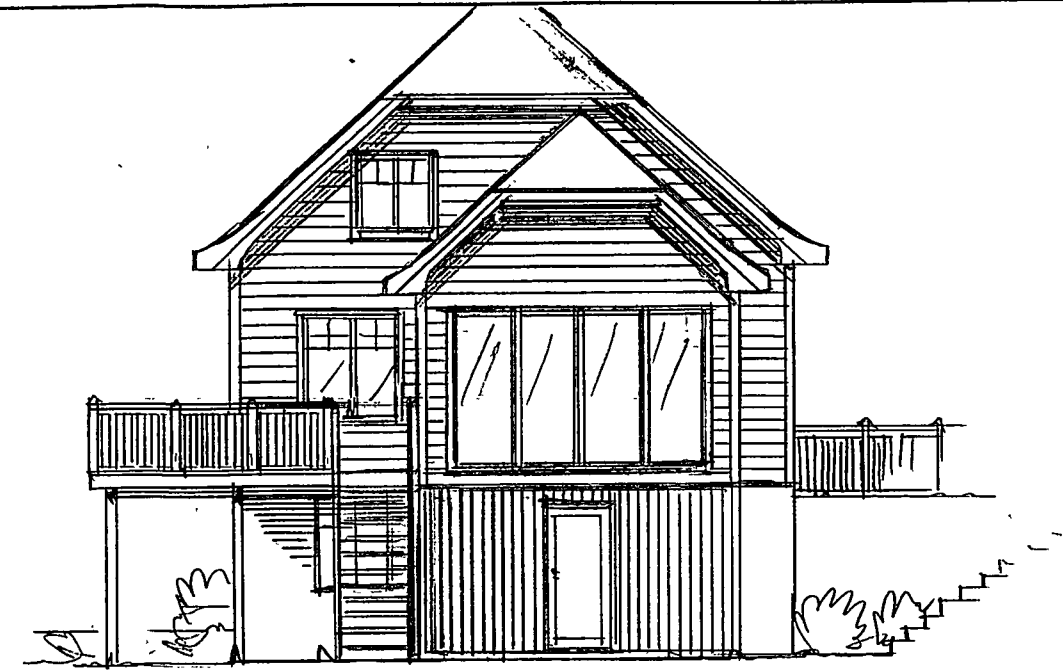

FASADE SØR

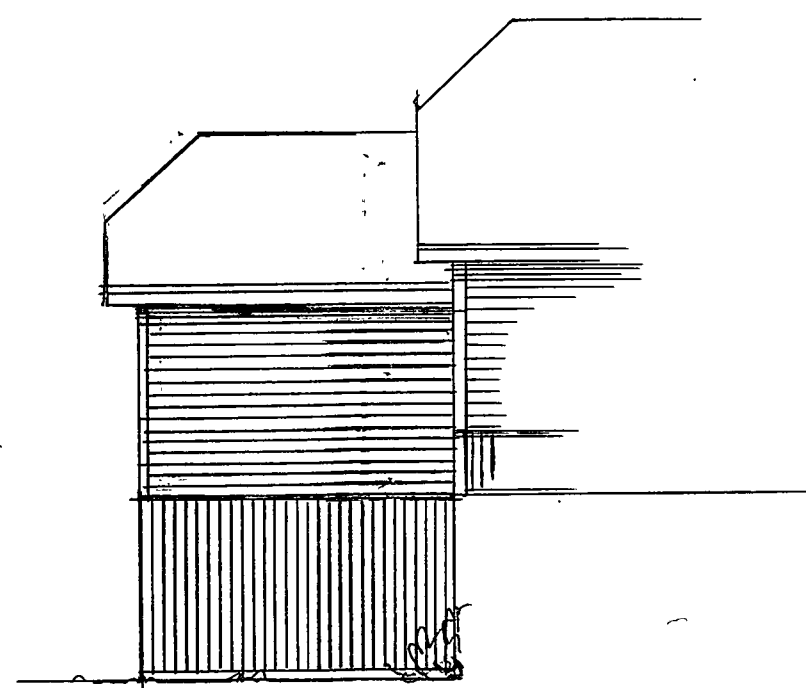

FASADE ØST

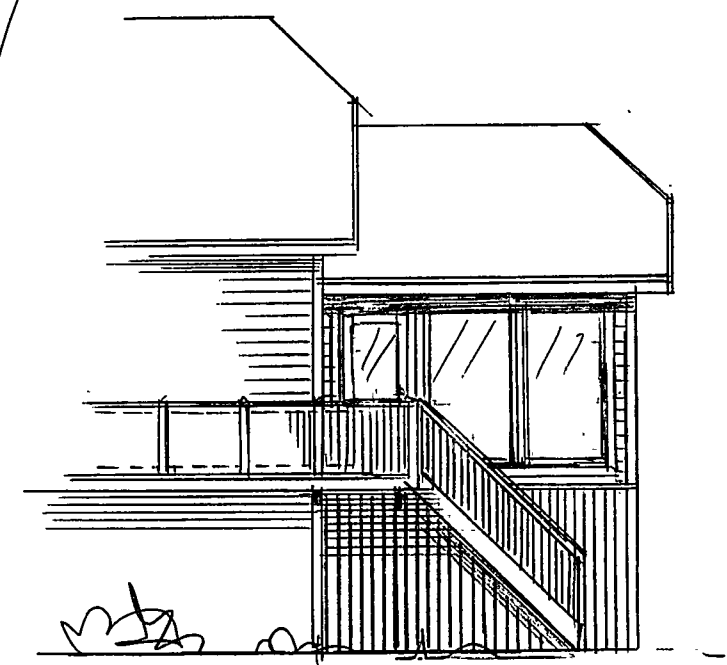

FASADE VEST

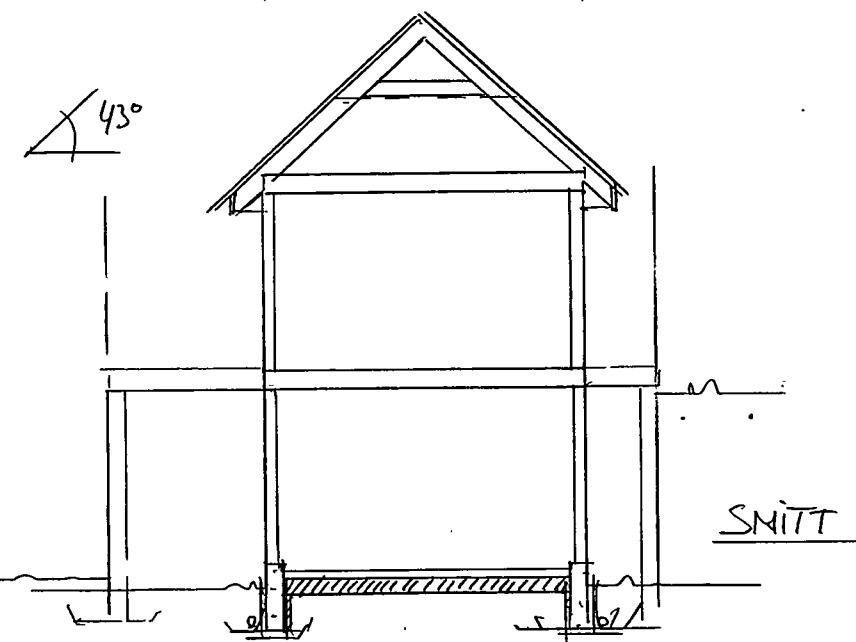

SNITT

BYA = 15,8 m²
 Bra = 13,5 + 13,5 = 27 m²

Dato	Konst/Tegnet	Godkjent	Målestokk	Gnr.
30.11.22	<i>L.Ø.</i>		1:100	5
ANN M. ANDREASSEN & LEIF STAVA				Bnr.
MULDRAKKARE 22, 4276 VEDAV.				422
Tegn. nr.	1	PLAN/SNITT/FAS.	TILBYGG	
			15,8 m ²	

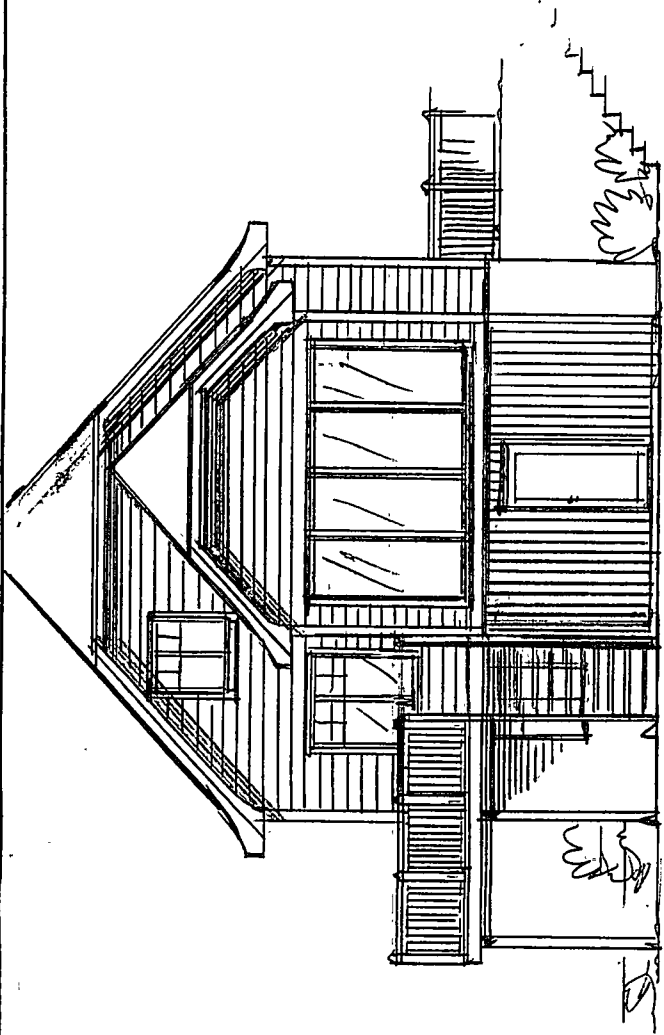

FASADE SØR

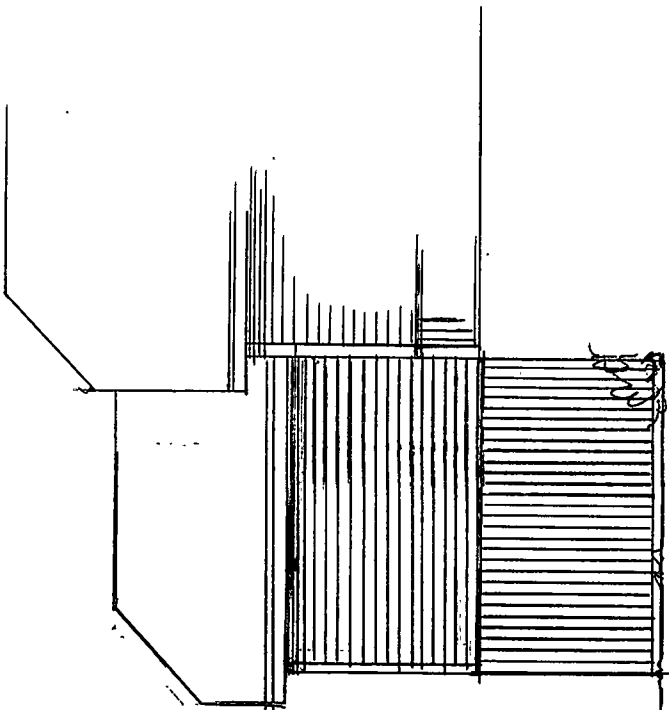

FASADE ØST

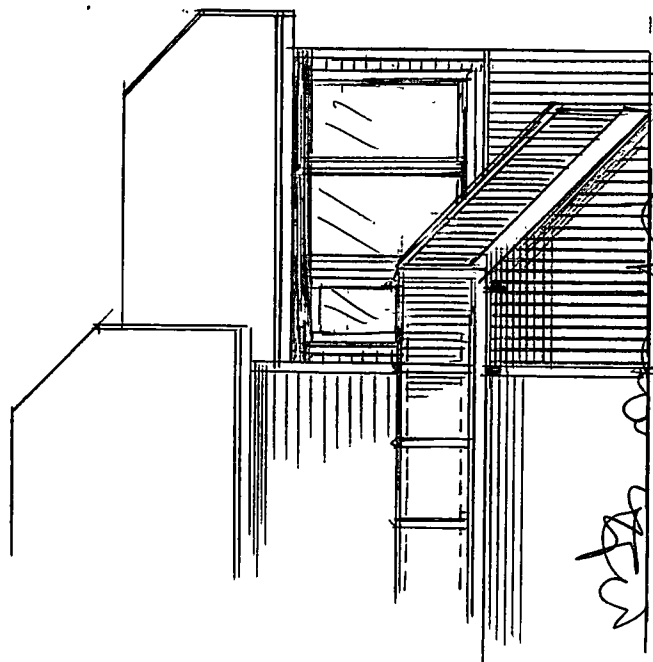

FASADE VEST

Kjeller PLAN

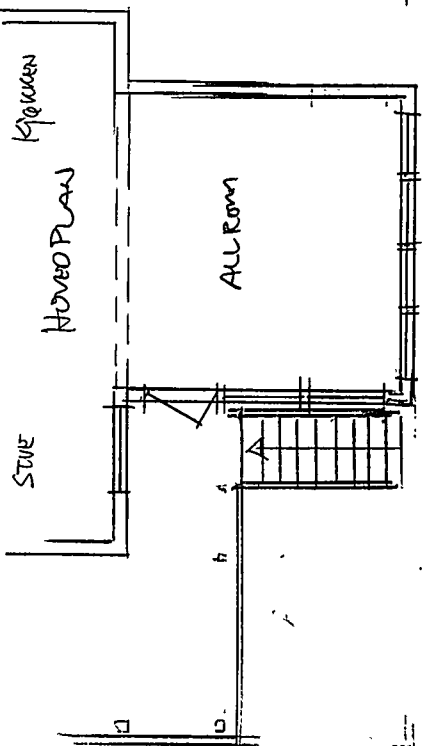
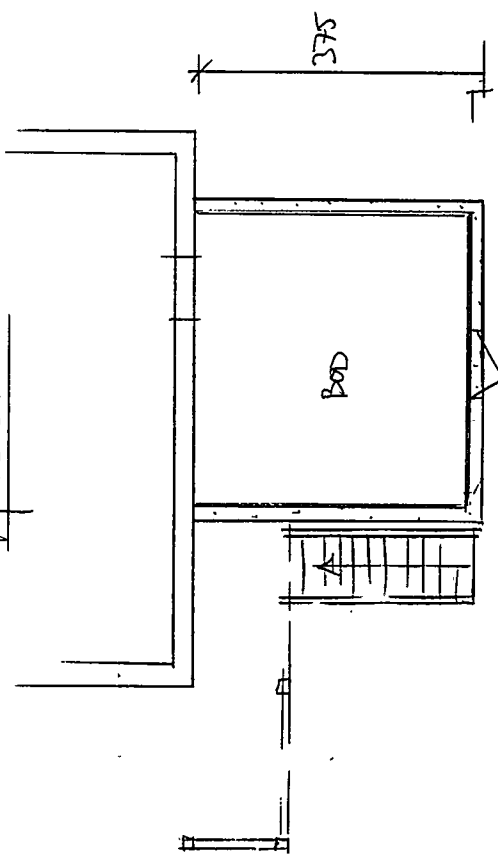

BYA = 15,8 m²

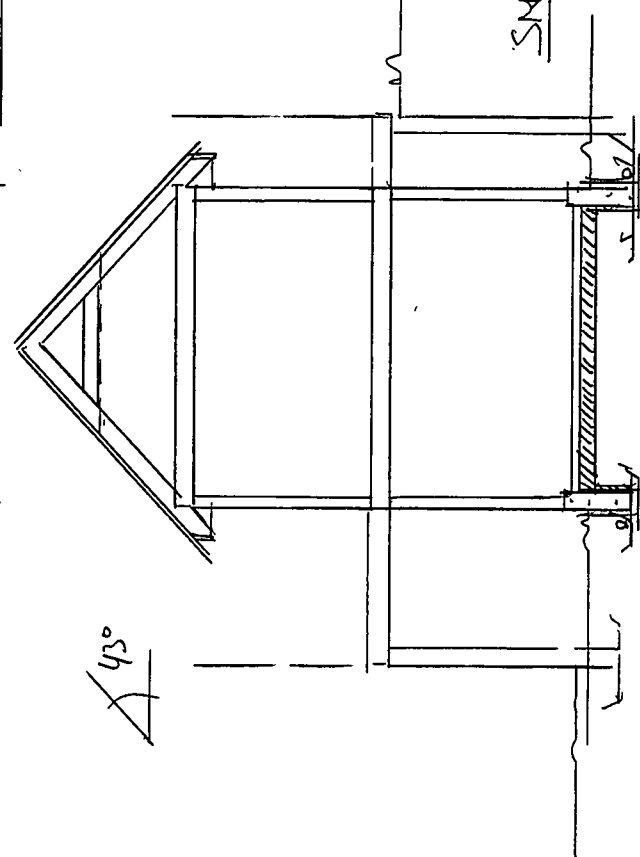

SMITT

BYA = 15,8 m²

BYØ = 13,5 + 13,5 = 27 m

Dato	Konst/Tegnet	Godkjent	Målestokk	Gnr.
30.11.22	T.Ø.		1:100	5
ANN M. ANDREASSEN & LEIF STAVA				Bnr.
MULD BARNHANEVE 22, 4276 VEDNÅ.				422
Tegn. nr. 1				TILBYGG
PLAN/SNITT/FAS.				15,8 m ²