













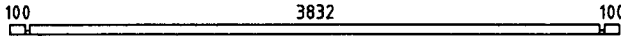
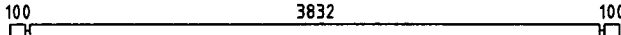
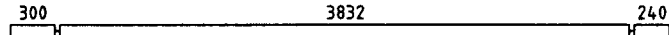
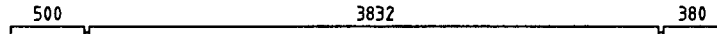
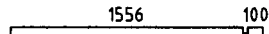
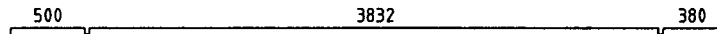
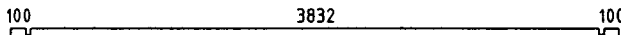
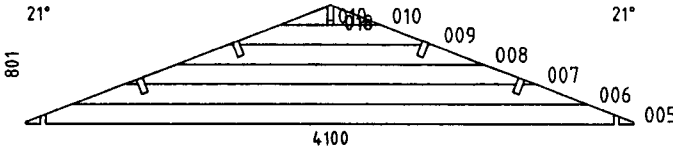
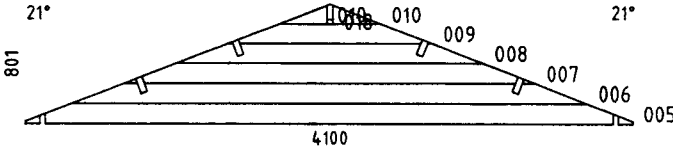

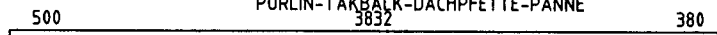

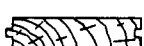
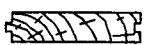

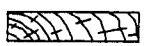
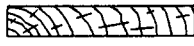
Djurö34

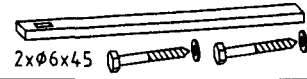

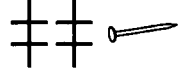
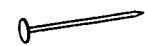
POS	SPECIFICATION Djurö34	QTY	PROFILE (mm)	LENGTH (mm)
001	100206 	2	34x68	340
002		2	34x68	340
003	100206 	28	34x135	340
004		28	34x135	340
011		1	34x68	4100
012		33	34x135	4100
013		2	34x135	4440
014		1	34x135	4780
015		14	34x135	1690
016		1	34x135	4780
EXTRA		1	34x135	4100
W1-1		1		
W2-1		1		
F2	FOUNDATION-GOLVBÄLKE-FUNDAMENT-FONDATION 	2	44x90	3890
F1	FOUNDATION-GOLVBÄLKE-FUNDAMENT-FONDATION 	7	44x90	3802
PL1	PURLIN-TAKBALK-DACHPFETTE-PANNE 	4	44x144	4780
PL2	PURLIN-TAKBALK-DACHPFETTE-PANNE 	1	44x144	4780
F-1	FLOOR BOARD-GOLVBRÄDA-FUSSBODENBRETT-LAME DE PLANCHER 	44+1 34+1	88x18 114x18	3822
R-1	ROOF BOARD-TAKBRÄDA-DACHBRETT-VOLIGE 	110+1 84+1	88x18 114x18	2400
	FLOOR BEADING-GOLVLIST-FUSSBODENLEISTE-MOULURE DE FINITION 18x40x3000 	5	18x40	15rmt.
GB-1	GABLE BOARD 95-GAVELBRÄDA-GIEBELBLLENDE-PLANCHE DE RIVE 	2	18x95	4780
Model Djurö34		Material		Page 1/3

POS	SPECIFICATION Djurö34		QTY	PROFILE (mm)	LENGTH (mm)
GB-1	GABLE BOARD 120-GAVELBRÄDA-GIEBELBLENDE-PLANCHE DE RIVE		4	18x120	2440
RL-1	ROOFING LATH 2000-TAKLÄKT-GIEBELLEISTE-LATTE DE RIVE		5	40x18	10rmt.
RL-2	ROOFING LATH 3000-TAKLÄKT-GIEBELLEISTE-LATTE DE RIVE		4	40x18	12rmt.
SS-1	STORM SLAT KIT-STORMSÄKRINGSLIST-STURMLEISTE SATZ-KIT DE LATTE ANTI TEMPÊTE	 2x $\phi$ 6x45	4	18x40	2000
D	DIAMOND-DIAMANT-DECKBRETT-LOSANGE DE DECORATION		2		
	DOUBLE DOOR KIT ISO-DUBBELDÖRR BESLAG-TÜR SATZ-KIT DOUBLE PORTE	 2x $\phi$ 3x25 4x $\phi$ 5x70 4x $\phi$ 5x90	1		
	NAIL 1.6x30-SPIK-NAGEL-CLOU		35	1.6x30	
N 1.8x40	NAIL 1.8x40-SPIK-NAGEL-CLOU		820	1.8x40	
S4x60	SCREW 4x60-SKRUV-SCHRAUBE-VIS		80	4x60	
S5x90	SCREW 5x90-SKRUV-SCHRAUBE-VIS		20	5x90	
S6x120	SCREW 6x120-SKRUV-SCHRAUBE-VIS		36	6x120	
	WINDOW HANDLE FITTINGS-FÖNSTERHANDTAG-FENSTERBESCHLAG-FERRURE DE FENÊTRE	 4x $\phi$ 3x25	1		
	WINDOW 700x900 W0-6DK 700x900-44 R ISO		1		
	WINDOW 550x1900 W08LU F 550x1900-34 ISO		2		

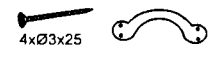
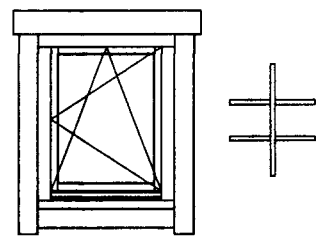
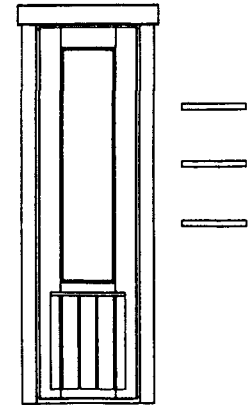



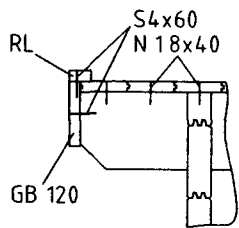

WALL A ↑

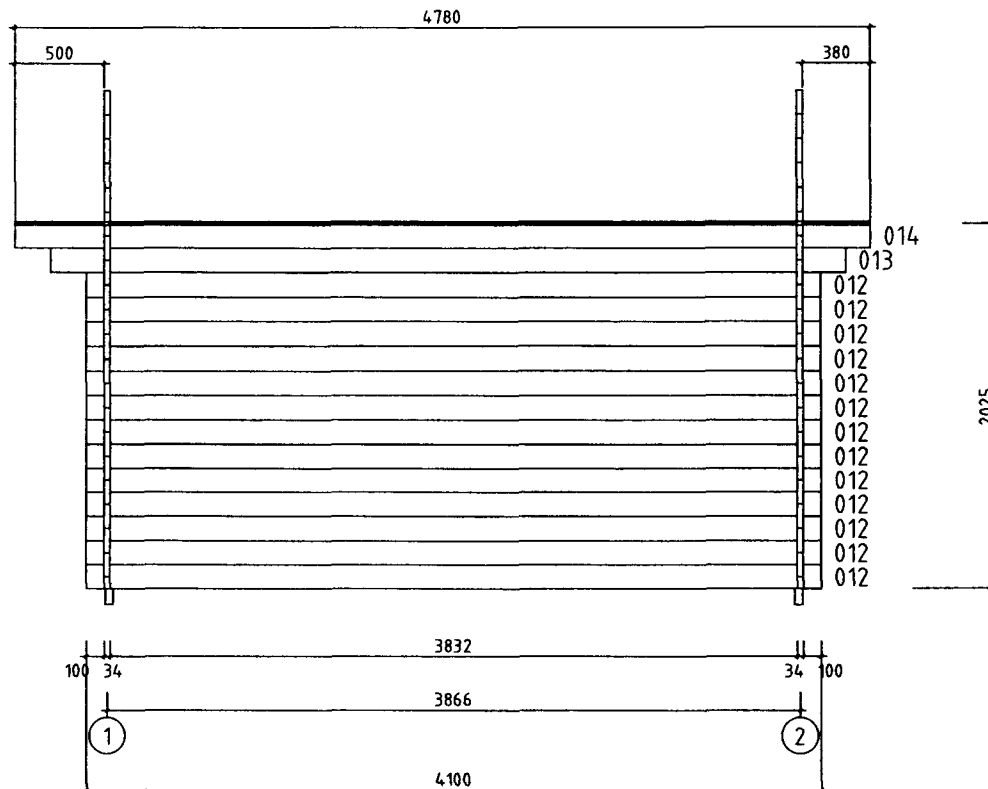

	Model	Djurö34	Page	3
	Drawing	WALL A	Scale	1:40
	Material	3.4x13.5	Date	07.12.2022
	File	Djurö34.dwg	Drawn by	

Model	Djur034	Page	
Drawing	PLAN	Scale	1:40
Material	34x135	Date	07.12.2022
File	Djur034.dwg	Drawn by	

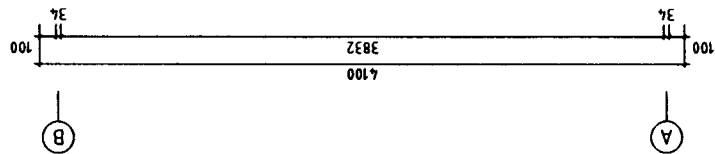
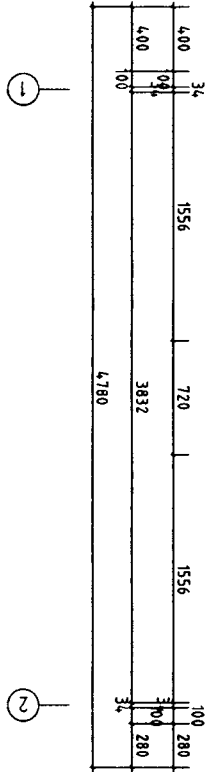
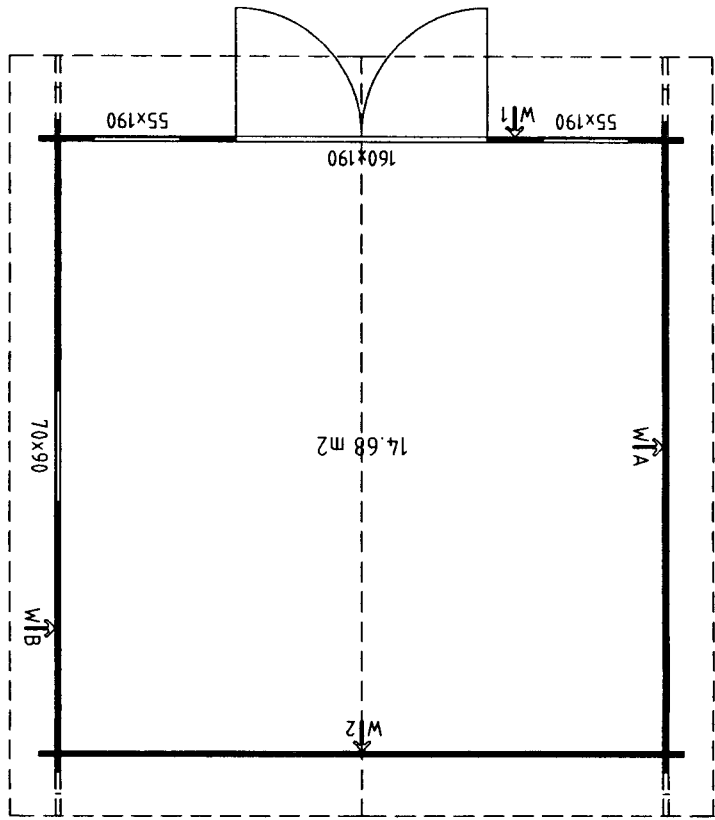
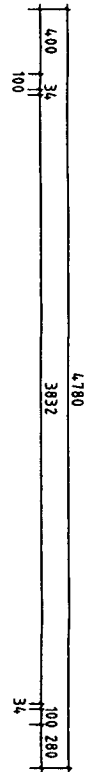
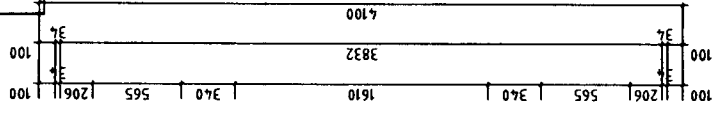

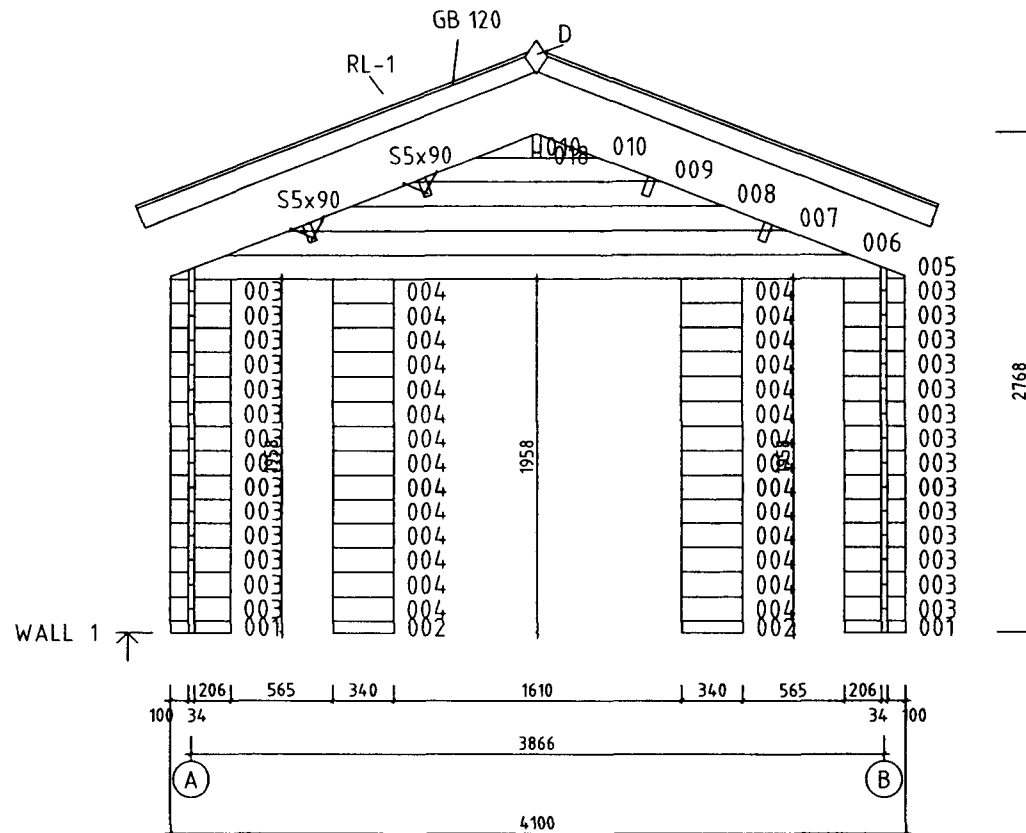
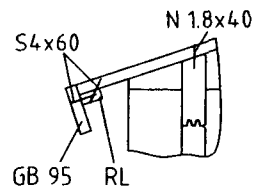



Model	Djurö34	Page	6
Drawing	WALL 1	Scale	1:40
Material	3.4x13.5	Date	07.12.2022
File	Djurö34.dwg	Drawn by	

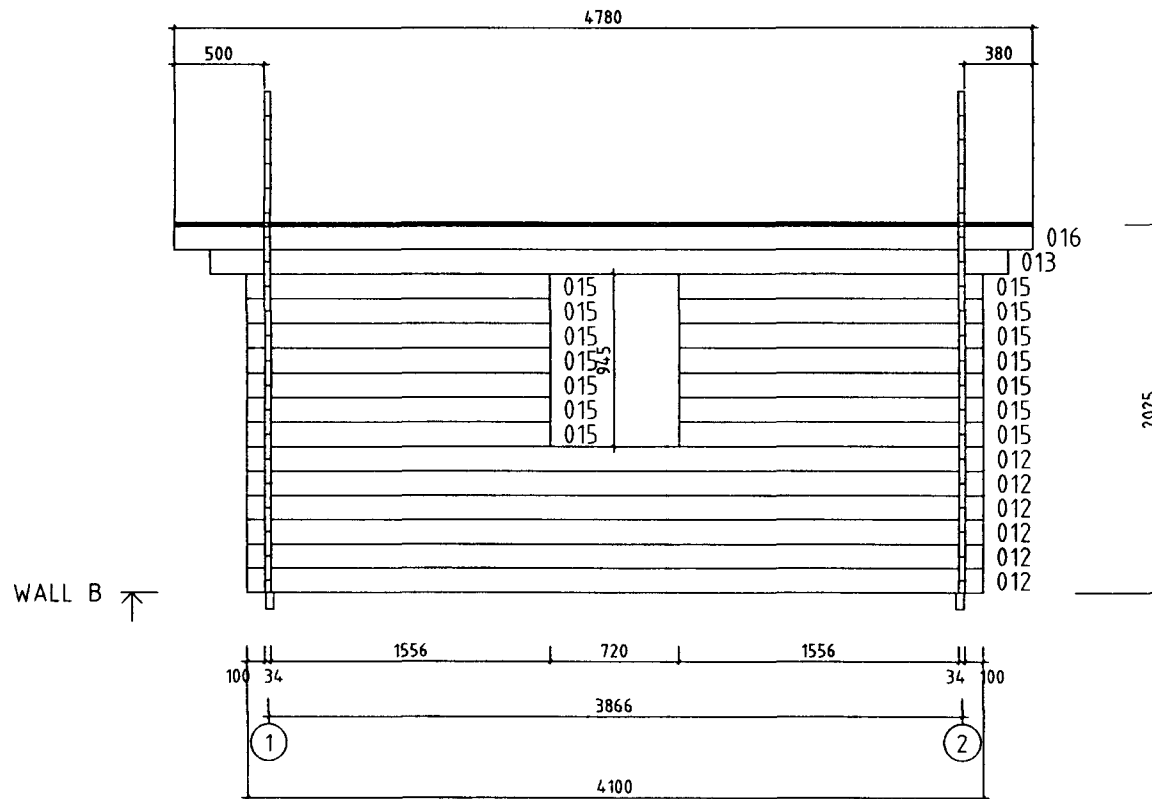

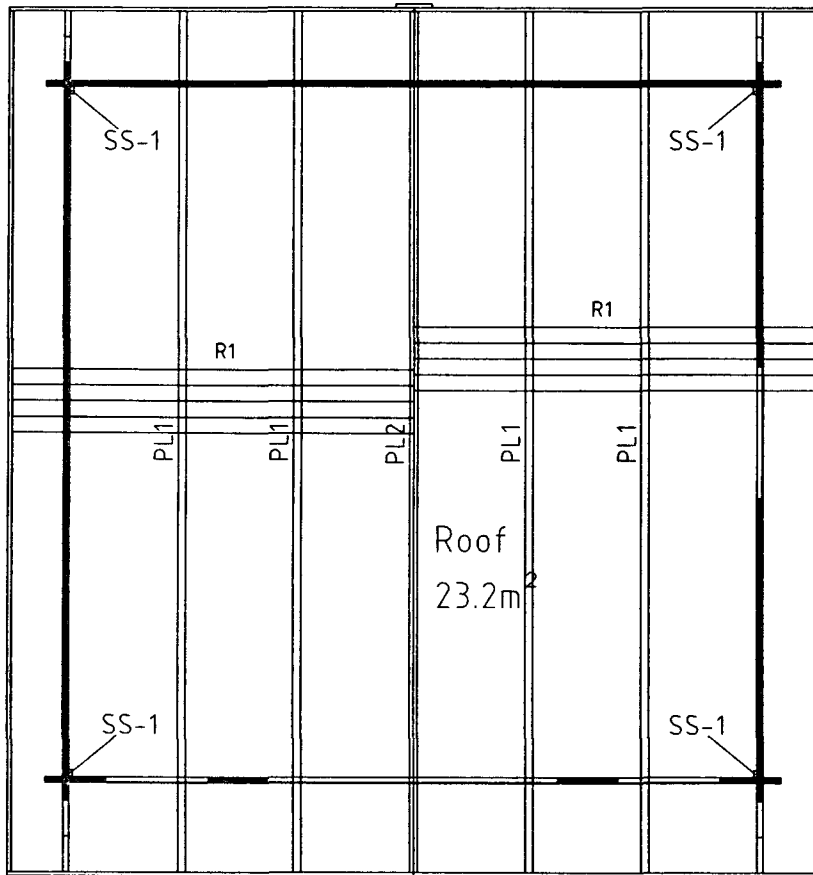

	Model	Djurö34	Page	4
	Drawing	WALL B	Scale	1:40
	Material	3.4x13.5	Date	07.12.2022
	File	Djurö34.dwg	Drawn by	



	Model	Djurö34	Page
	Drawing	ROOF	Scale 1:40
	Material	34x135	Date 07.12.2022
	File	Djurö34.dwg	Drawn by

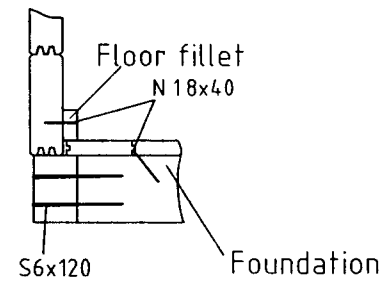
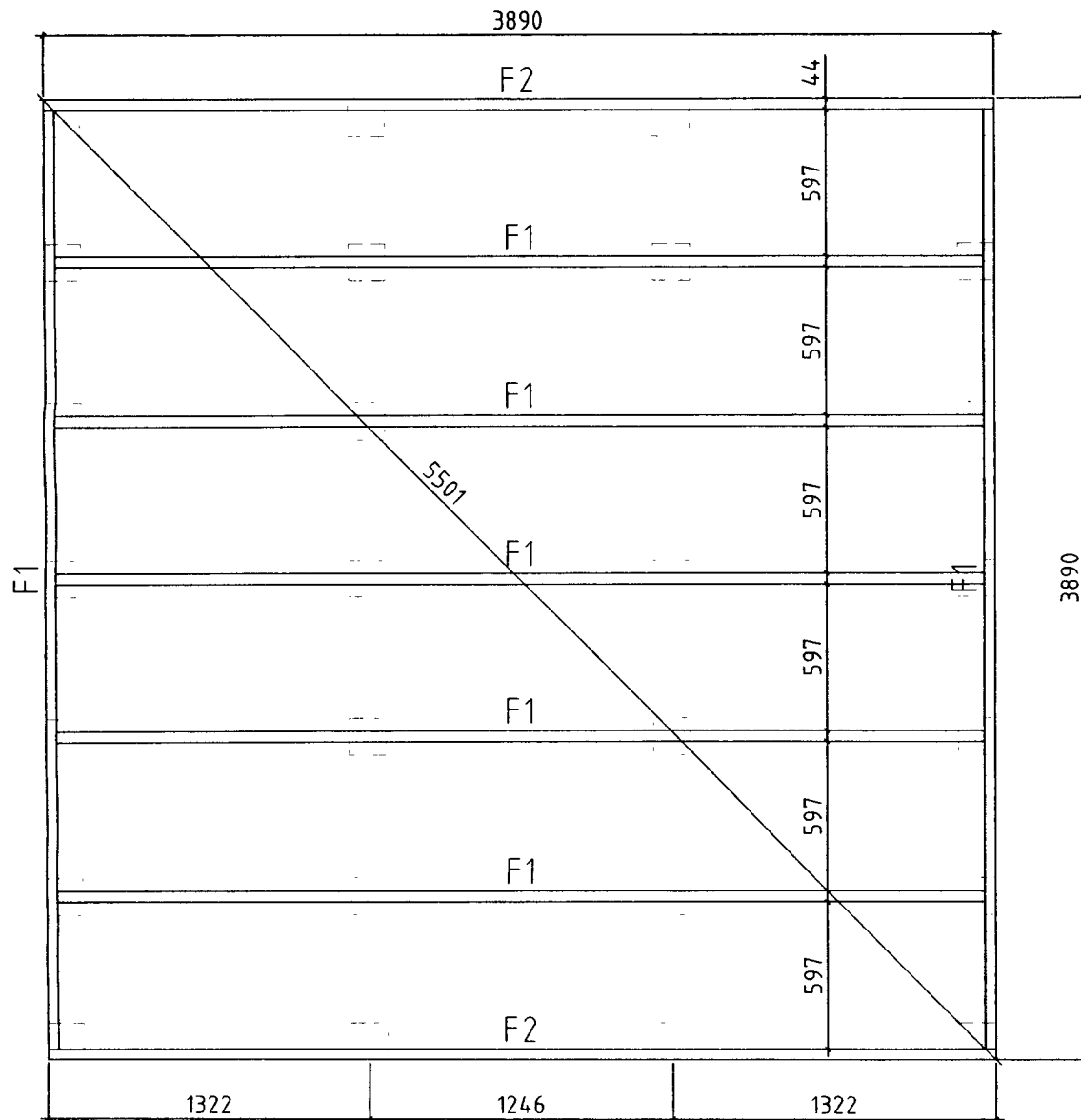

Model	Djurö34	Page	
Drawing	FOUNDATION-PLINTH PLAN	Scale	1:40
Material	34x135	Date	07 12 2022
File	Djurö34.dwg	Drawn by	

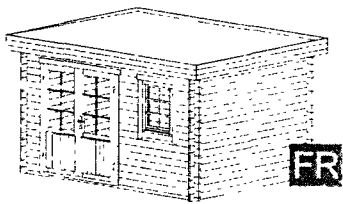

FR

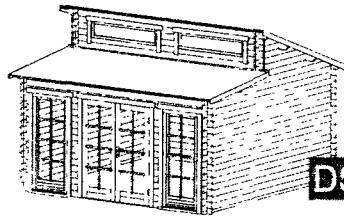

DSR

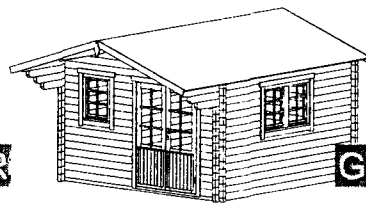

GR

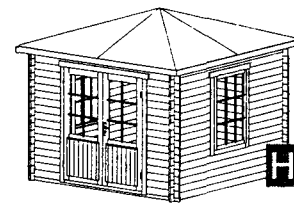

HR

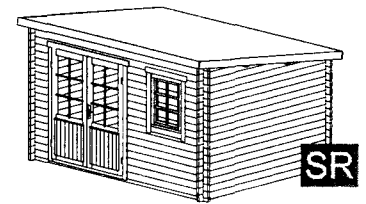

SR

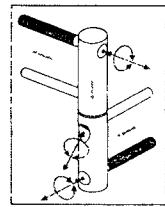
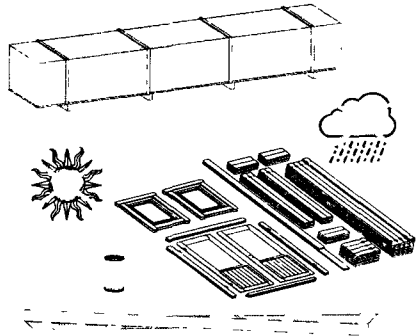

ADJUSTABLE HINGES

3.

TYPE-A  
5x90

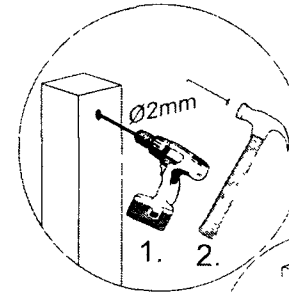

1.

2.

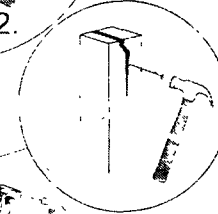

4.

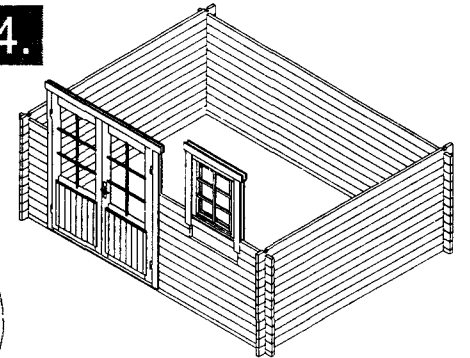

1.

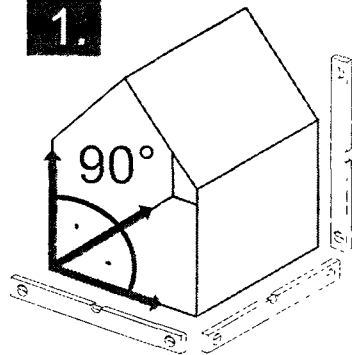

90°

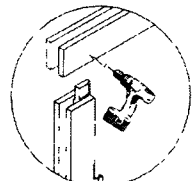

TYPE-B  
4x60

OPTIONS

OPTIONS

5.

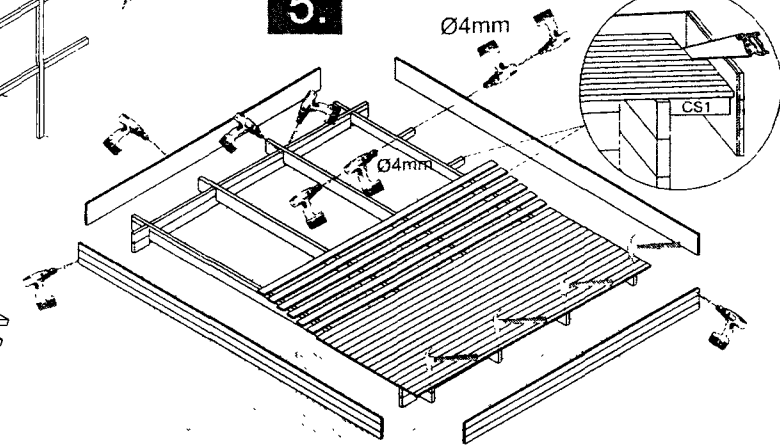

Ø4mm

FR

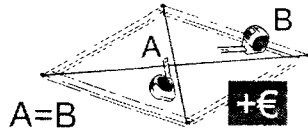

A=B

+€

TYPE-A  
5x70

NB!

OPTIONS

2.

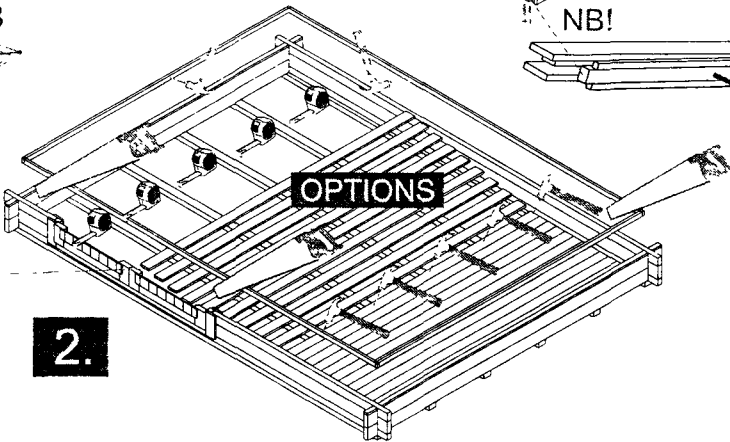

The guide is illustrative. This guide is not project specification.  
Der Leitfaden ist illustrativ. Dieser Leitfaden ist keine Projektspezifikation.  
De gids is illustratief. Deze gids is geen projectspecificatie.

