

3 3D Oljeutskiller
Allerede montert

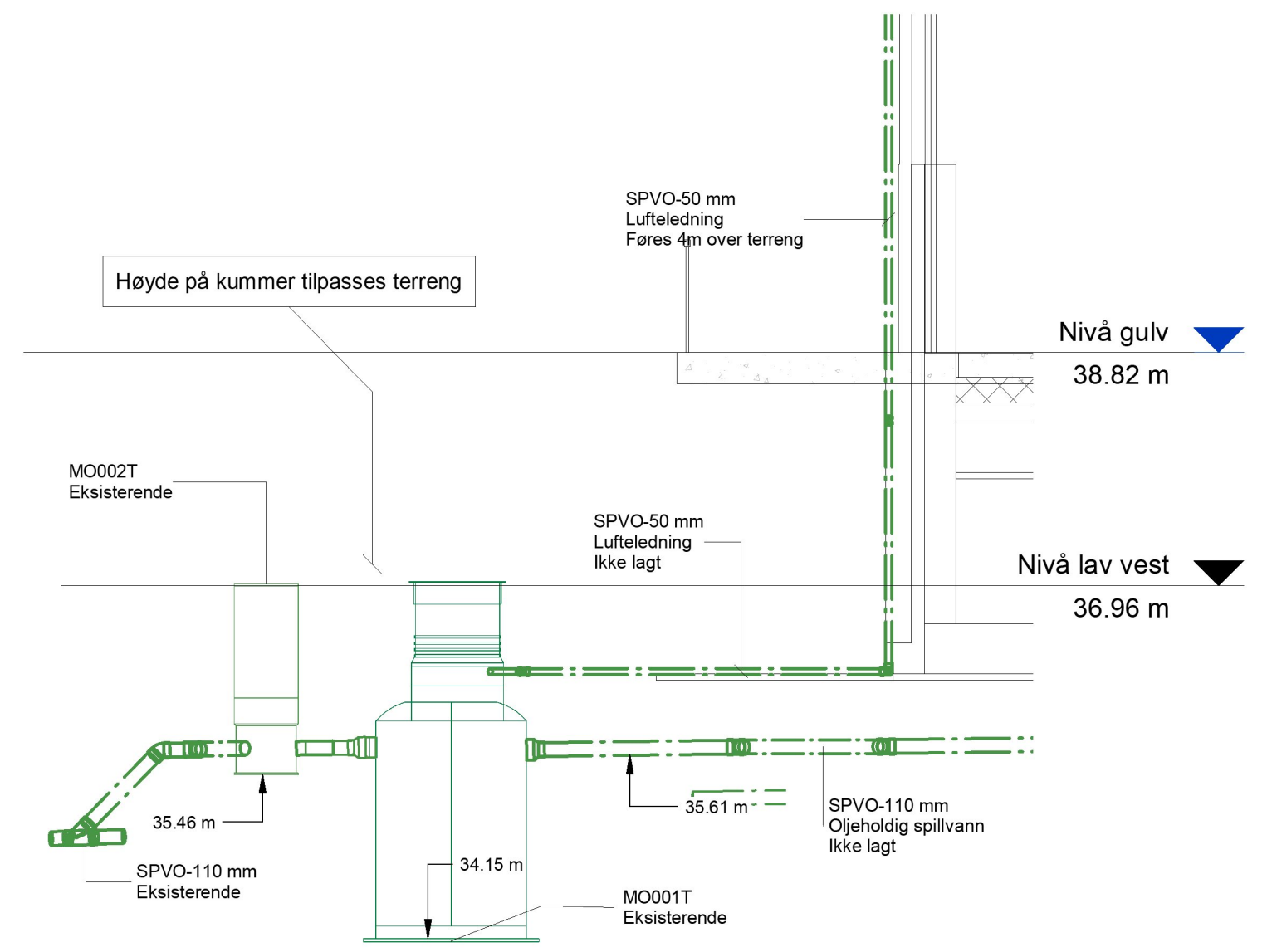

2 Snitt oljeutskiller
1 : 50

Tegn. nr V-10-UH-30-00-2021		Rev. B
TEGNFORKLARING		
Drens	---	
Spillvann	---	
Overvann	---	
Radonsikring	---	
Vannledning	---	
Overvannsrenne	---	
Taknedløp 6-13 avsluttes 2,5m over bakkenivå. Taknedløp 1-5-13 avsluttes ved taksluk		
Rev	Revideringen gjelder	Tegn. Kontr. Dato.
KARMØY KOMMUNE		ED DATO
P56800 - NY GJENVINNGSSTASJON BORGAREDALEN Utendørsplan VVS		KONTR. SAL DATO 16.11.22
Målestokk: As indicated		Status: TILBUDSTEGNING
Prosj nr 2321		Tegn. nr V-10-UH-30-00-2021
Ferkingsstad og Alsaker RÅDGIVENDE INGENIØRER VVS Karmundgt.159 - 5522 Haugestrand - TR 52 70 53 80		Rev. B



FCB/BAI: (8416294)

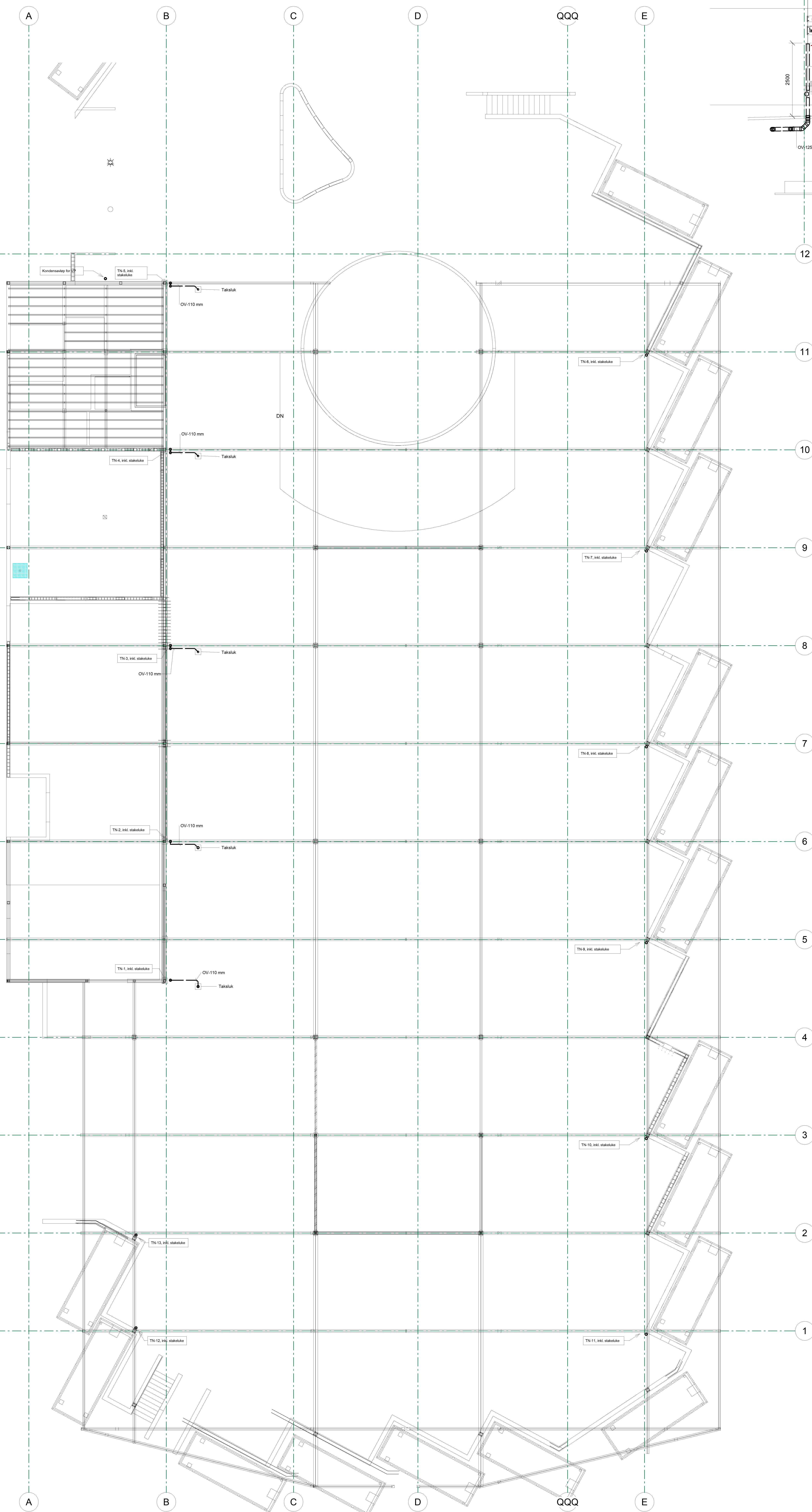

1 Plan under yttertak - Utskrift
1 : 100

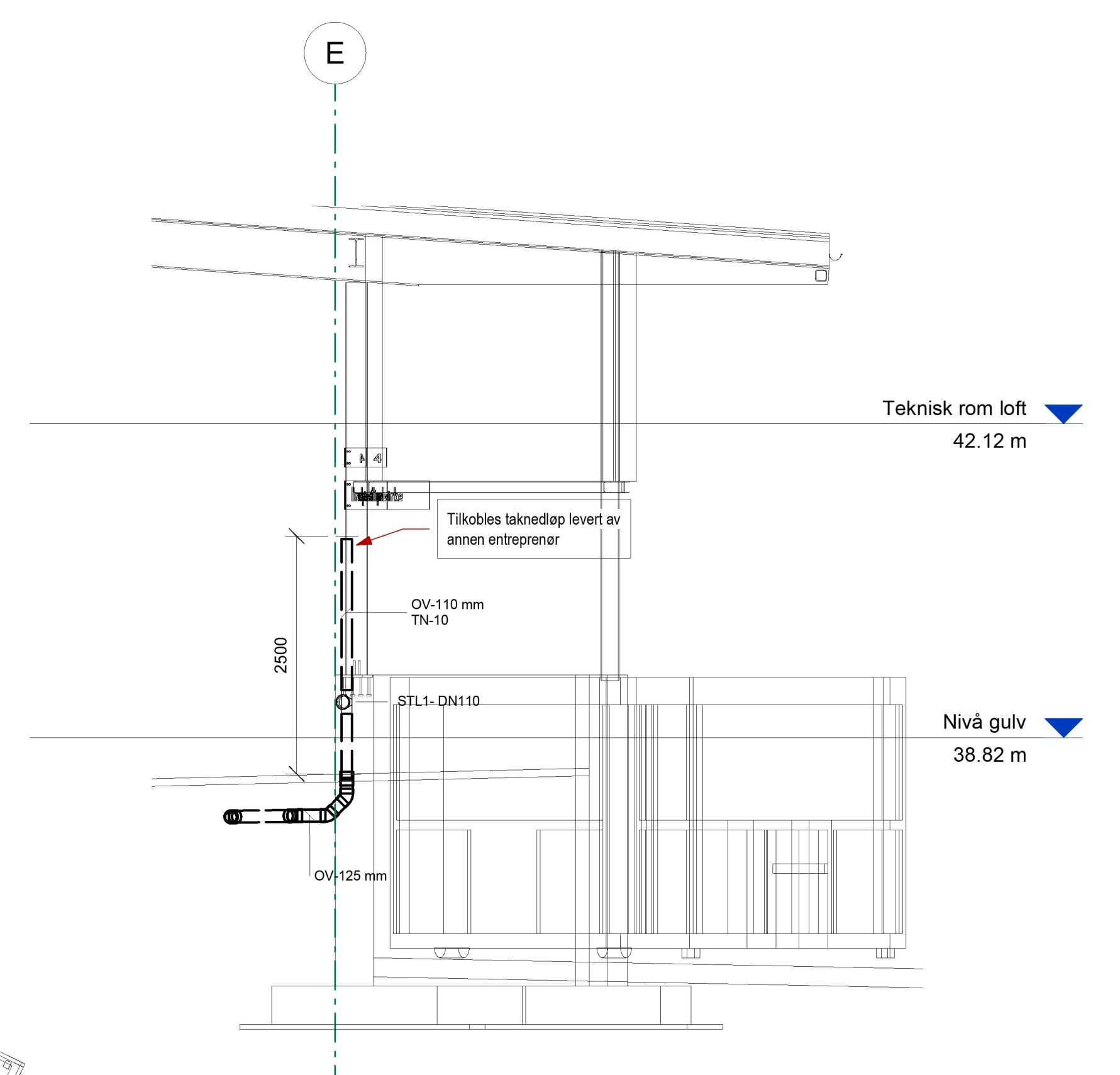

2 Prinsipp taknedløp
1 : 50

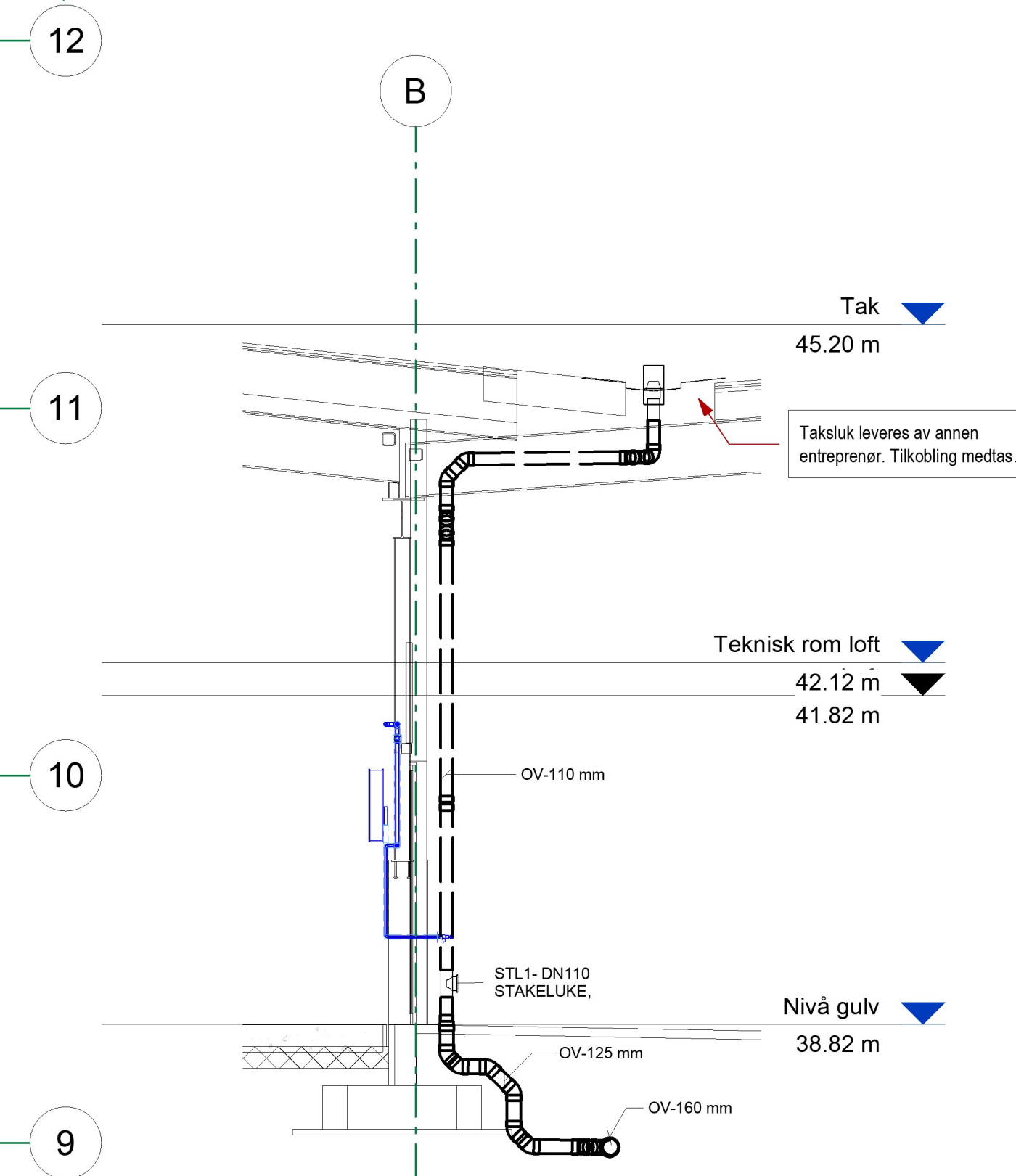

3 Prinsipp taksluk
1 : 50

TEGNFORKLARING		Fig. nr	Rev
Drens	---	V-10-UH-31-01-2022	
Spillvann	---		
Overvann	---		
Radonsikring	---		
Vannledning	---		
Overvannsrenne	---		

Taksnedløp 6-13 avsluttes 2.5m over bakkenivå.	
Taksnedløp 1-5-13 avsluttes ved taksluk	

Tilbudstegnning	Totaltpris	ED	SAL	09.02.23
Tilbudstegnning	Byggetinnlegg	ED	SAL	04.04.22
Rev	Revisjonen gjelder	Tegn	Kont	Dato
KARMØY KOMMUNE		ED	SAL	
P56800 - NY GJENVINNINGSTASJON BORGAREDALEN		KONTRE	SAL	14.03.22
Overvann fra sedumtak		Årskv	SAL	
		Status	As indicated	
		Prosjekt	TILBUDSTEGNING	
		Prosjekt nr	2321	
		Fig. nr	V-10-UH-31-01-2022	



Ferkingstad og Alsaker



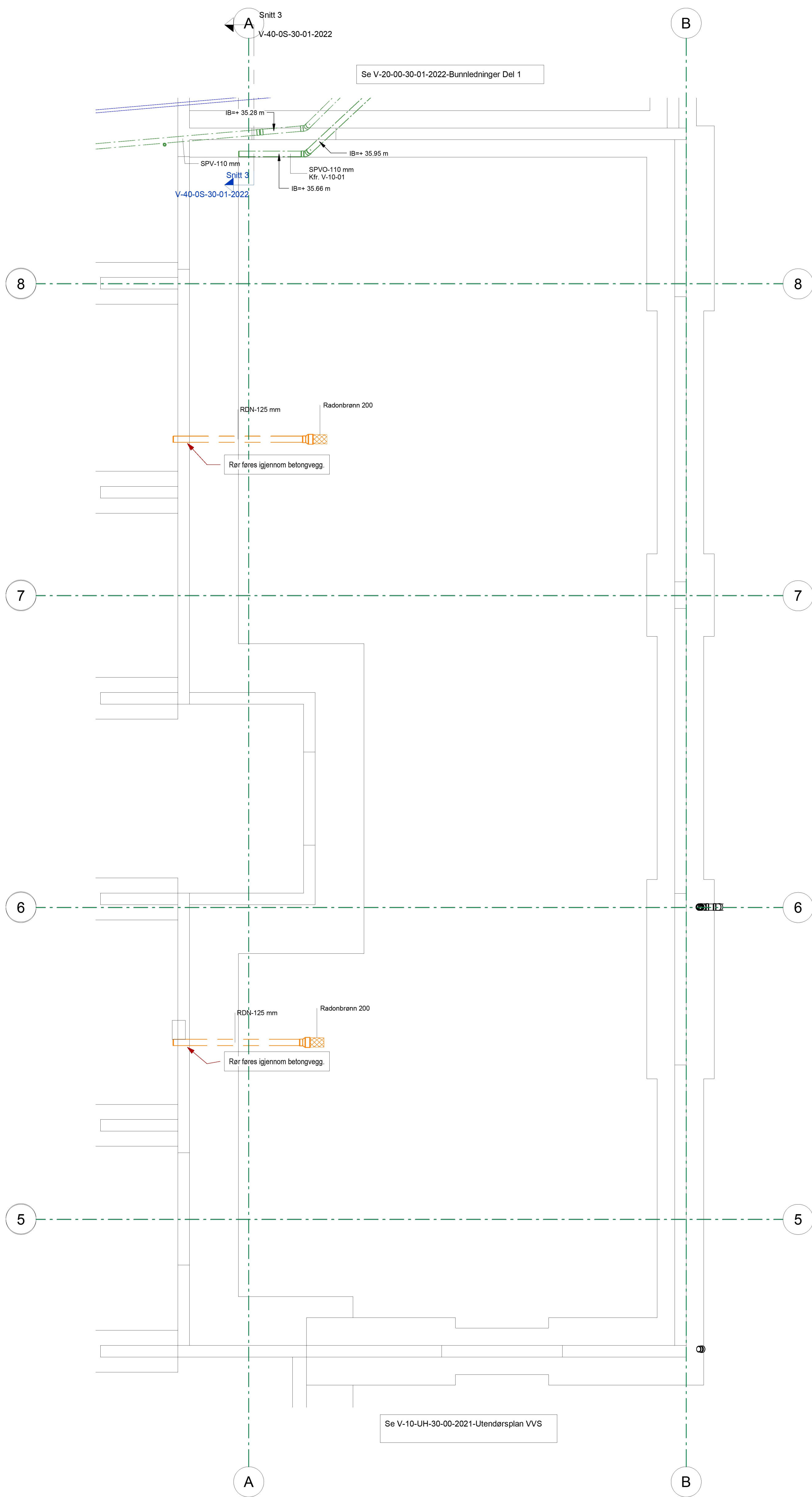

1 Bunnledninger Del 2 - Utskrift
1 : 50

Tegn. nr V-20-00-30-02-2022		Rev.		
TEGNFORKLARING				
Drens				
Spillvann				
Overvann				
Radonsikring				
Vannledning				
Overvannssrenne				
Rev	Tilbudstegning Totalentreprise	ED	SAL	09.02.23
	Tilbudstegning Byggetrinn HEB	ED	SAL	04.04.22
	Revideringen gjelder	Tegn.	Kontr.	Dato.
	KARMØY KOMMUNE	TEGN	ED	DATO
	P56800 - NY GJENVININGSSTASJON BORGAREDALEN	KONTR	SAL	DATO
	Bunnledninger Del 2			16.02.22
	Målestokk:	As indicated		
	Status:	TILBUDSTEGNING		
	Prosj.nr	2321		
	Tegn. nr	V-20-00-30-02-2022		
	Rev.			



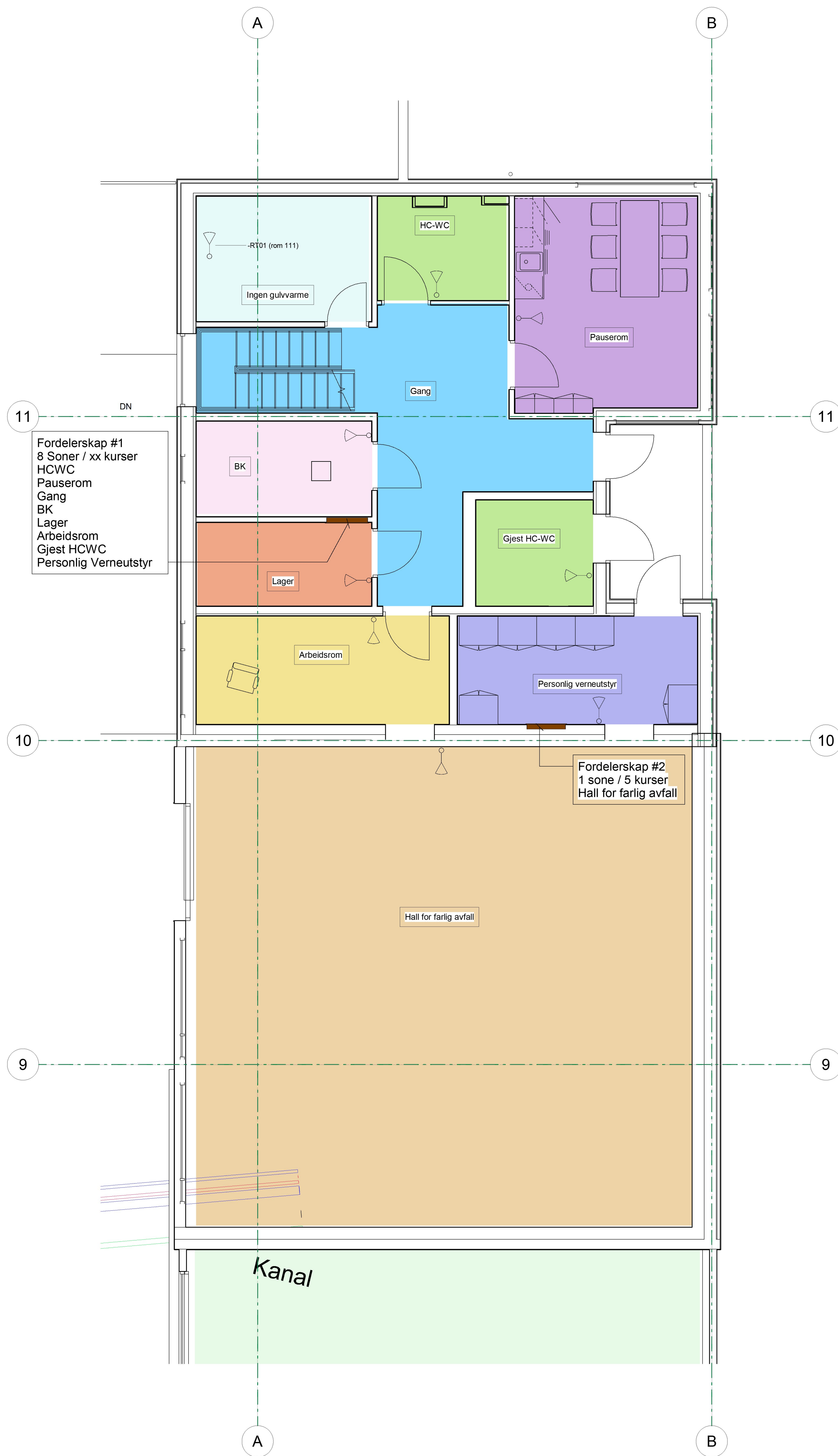

- Fordelerskap #1
- 8 Soner / xx kurser
- HCWC
- Pauserom
- Gang
- BK
- Lager
- Arbeidsrom
- Gjest HCWC
- Personlig Verneutstyr

Rev	Tilbudstegning Byggetrinn HEB	Tegn.	ED	DATO	09.02.23
		Kontr.	SAL	Dato.	04.04.22

Tilbudstegning Totalentreprise		ED	SAL	09.02.23
Tilbudstegning Byggetrinn HEB		ED	SAL	04.04.22
Rev	Revideringen gjelder	Tegn.	Kontr.	Dato.
KARMØY KOMMUNE		TEGN	ED	DATO
P56800 - NY GJENVININGSSTASJON BORGAREDALEN		KONTR	SAL	DATO
Gulvvarme Del 1		Målestokk:	1 : 50	
		Status:	TILBUDSTEGNING	
		Prosj nr	2321	
		Tegn nr	V-20-00-32-01-2022	
		Rev.		



Ferkingstad og Alsaker
RÅDGIVENDE INGENIØRER VVS
Karmsundgt. 159 - 5522 Haugesund - Tlf 52 70 53 80



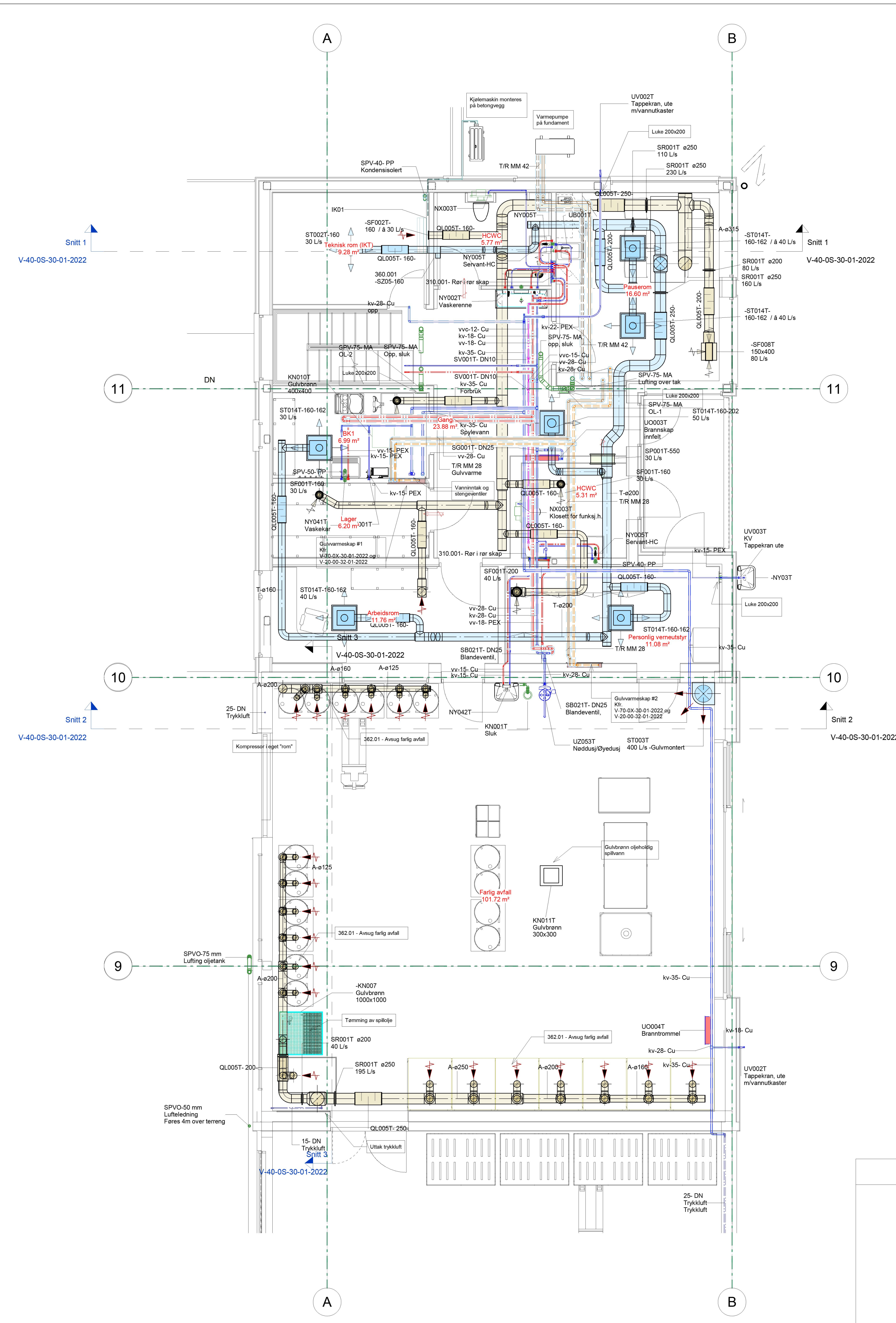

Tegn. nr V-20-01-30-01-2022		Rev.								
<table border="1"> <tr> <td>Tilbudstegning Totalentreprise</td> <td>ED</td> <td>SAL</td> <td>09.02.23</td> </tr> <tr> <td>Tilbudstegning Byggetrinn HEB</td> <td>ED</td> <td>SAL</td> <td>04.04.22</td> </tr> </table>			Tilbudstegning Totalentreprise	ED	SAL	09.02.23	Tilbudstegning Byggetrinn HEB	ED	SAL	04.04.22
Tilbudstegning Totalentreprise	ED	SAL	09.02.23							
Tilbudstegning Byggetrinn HEB	ED	SAL	04.04.22							
Rev. Revideringen gjelder		Tegn. Kontr. Dato.								
KARMØY KOMMUNE P56800 - NY GJENVINNINGSTASJON BORGAREDALEN Plan 1.etg Del 1		TEGN. ED DATO KONTR. SAL DATO Målestokk: 1 : 50 Status: TILBUDSTEGNING Prosj. nr: 2321 Tegn. nr: V-20-01-30-01-2022								



Ferkingsstad og Alsaker
 RÅDGIVENDE INGENIØRER VVS
 Karmundgt. 159 - 5522 Haugesund - Tlf 52 70 53 80

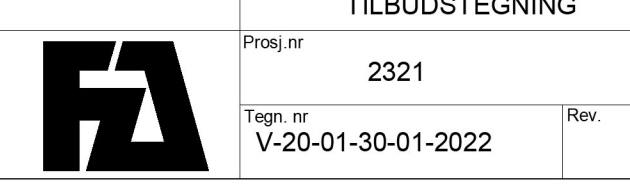

FCB/MAT: (254641)

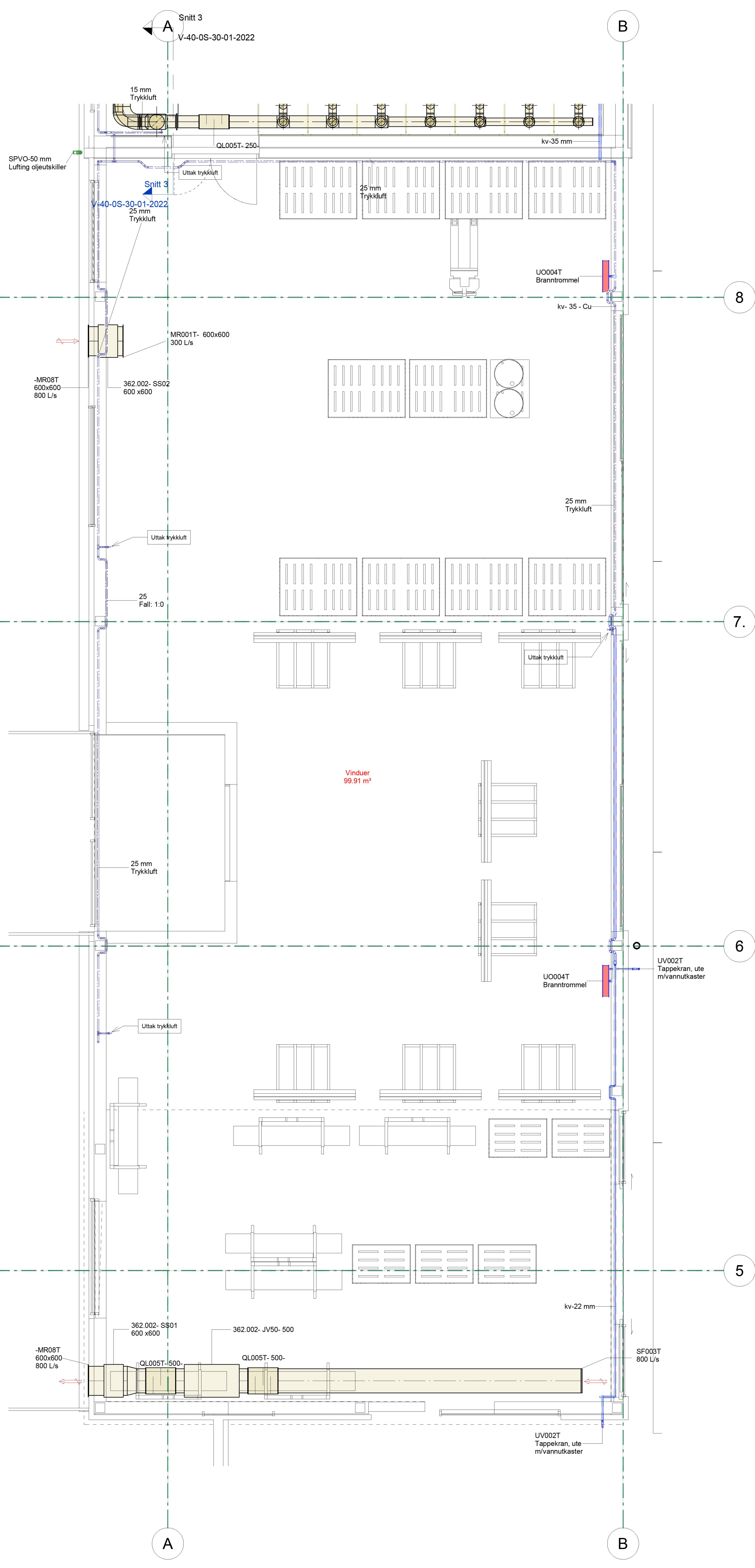

Rev	Tegn. nr	Rev.
	V-20-01-30-02-2022	

Tilbudstegning Totalentreprise	ED	SAL	09.02.23
Tilbudstegning Byggetrinn HEB	ED	SAL	04.04.22
Rev	TEGN	KONTR	DATO
	ED	SAL	16.02.22
Målestokk:	1 : 50		
Status:	TILBUDSTEGNING		
Prosj nr	2321		
Tegn. nr	V-20-01-30-02-2022	Rev.	



KARMØY KOMMUNE
 RÅDGIVENDE INGENIØRER VVS
 Karmundgt. 159 - 5522 Haugesund - Tlf 52 70 53 80



Ferkingstad og Alsaker
 RÅDGIVENDE INGENIØRER VVS
 Karmundgt. 159 - 5522 Haugesund - Tlf 52 70 53 80

FORBILDE (25/06/21)

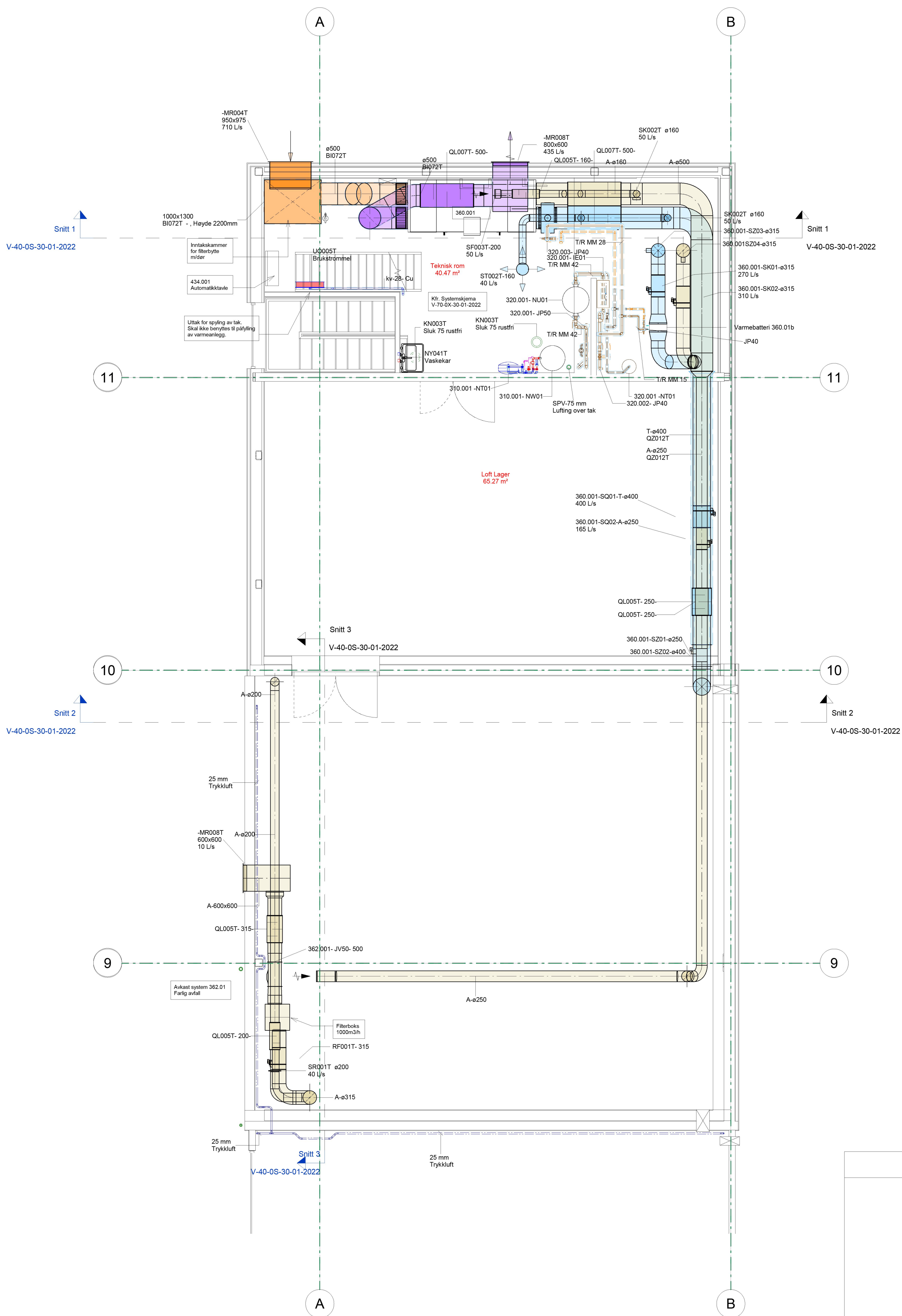

Tegn. nr	V-20-02-30-01-2022	Rev.	
----------	--------------------	------	--

Tilbudstegning Totalentreprise	ED	SAL	09.02.23
Tilbudstegning Byggetrinn HEB	ED	SAL	04.04.22
Rev	TEGN	KONTR	DATO
	ED	SAL	16.02.22
Målestokk:	1 : 50		
Status:	TILBUDSTEGNING		
Prosj nr	2321		
Tegn. nr	V-20-02-30-01-2022	Rev.	



Ferkingstad og Alsaker
RÅDGIVENDE INGENIØRER VVS
Karmsundgt. 159 - 5522 Haugesund - Tlf 52 70 53 80



F030421 (25x64x1)

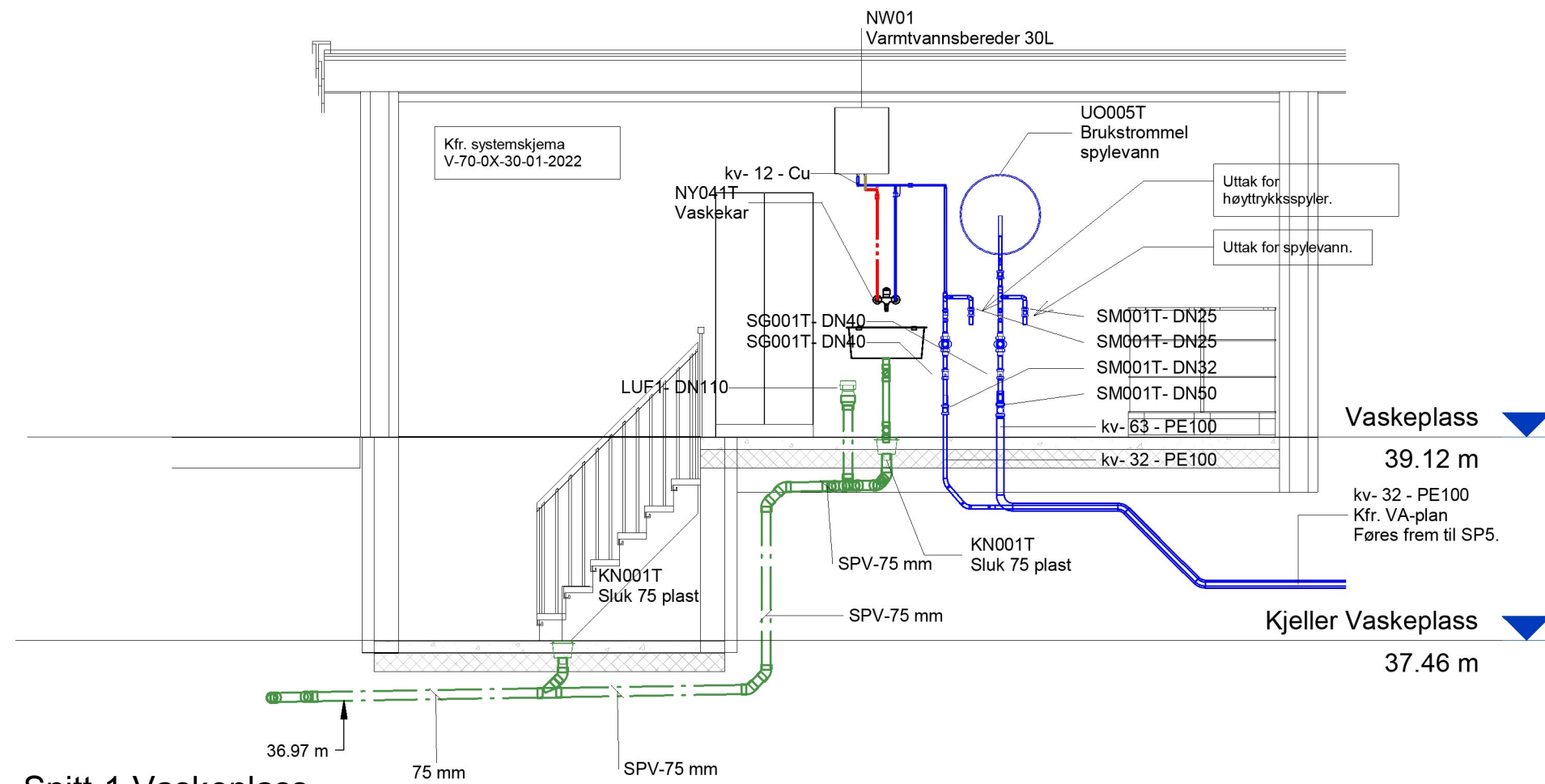

4 Snitt-1 Vaskeclass
1 : 50

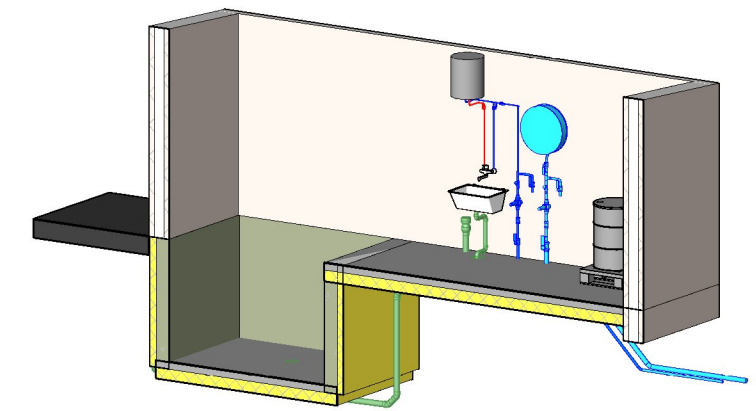

3 3D Vaskeclass

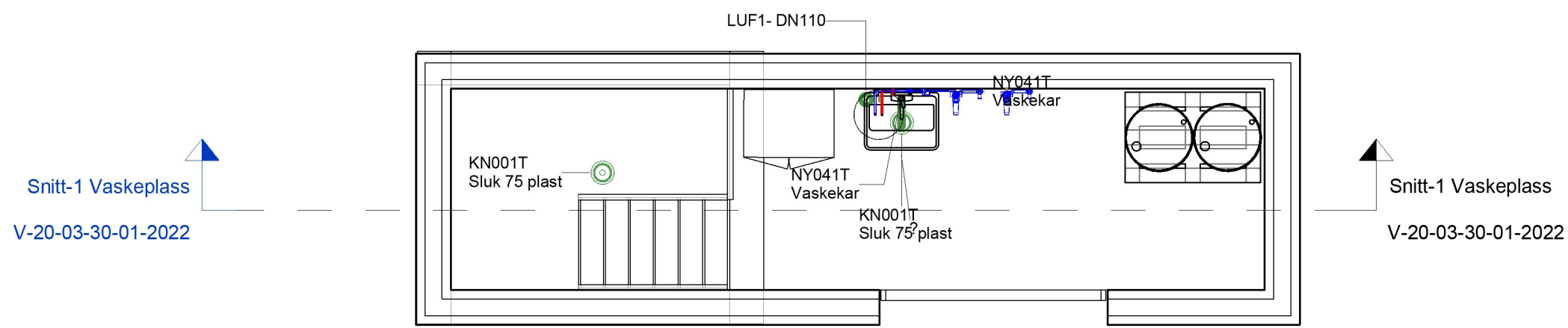

1 1.etg. Vaskeclass Utskrift
1 : 50

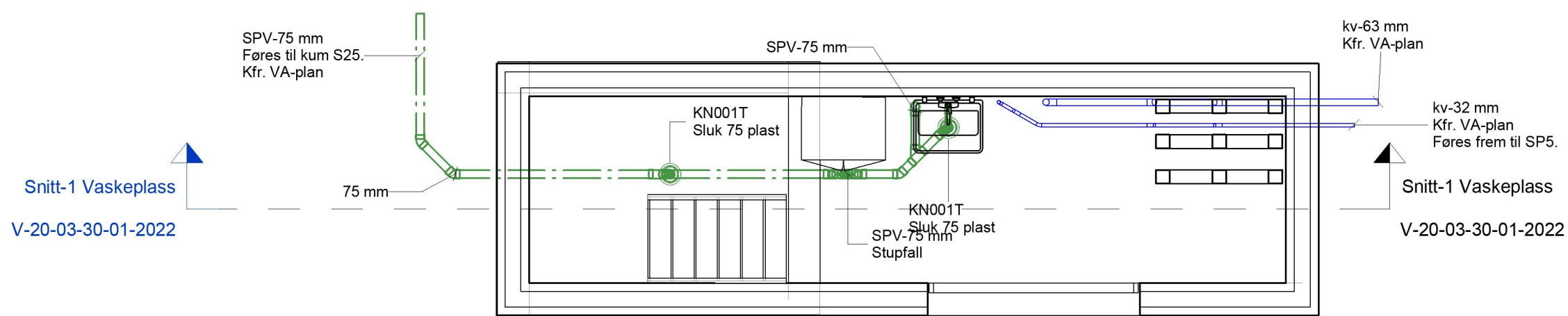

2 Bunnledninger Vaskeclass Utskrift
1 : 50

Tegn. nr
V-20-03-30-01-2022

Rev.

Tilbudstegning Totalentreprise	ED	SAL	09.02.23
Tilbudstegning Byggetrinn HEB	ED	SAL	04.04.22
Rev	TEGN.	KONTR.	DATO
	ED		
KARMØY KOMMUNE		SAL	DATO 16.02.22
P56800 - NY GJENVINNGSSTASJON BORGAREDALEN		Målestokk:	1 : 50
Plan og snitt Vaskeclass		Status:	TILBUDSTEGNING
Proj.nr 2321		Tegn. nr	V-20-03-30-01-2022
Tilbudstegning Totalentreprise		ED	SAL
Tilbudstegning Byggetrinn HEB		ED	SAL
Rev	TEGN.	KONTR.	DATO
	ED		
KARMØY KOMMUNE		SAL	DATO 16.02.22
P56800 - NY GJENVINNGSSTASJON BORGAREDALEN		Målestokk:	1 : 50
Plan og snitt Vaskeclass		Status:	TILBUDSTEGNING
Proj.nr 2321		Tegn. nr	V-20-03-30-01-2022



KARMØY
KOMMUNE



Ferkingstad og Alsaker
RÅDGIVENDE INGENIØRER VVS
Karmsundgt.159 - 5522 Haugesund - Tlf 52 70 53 60



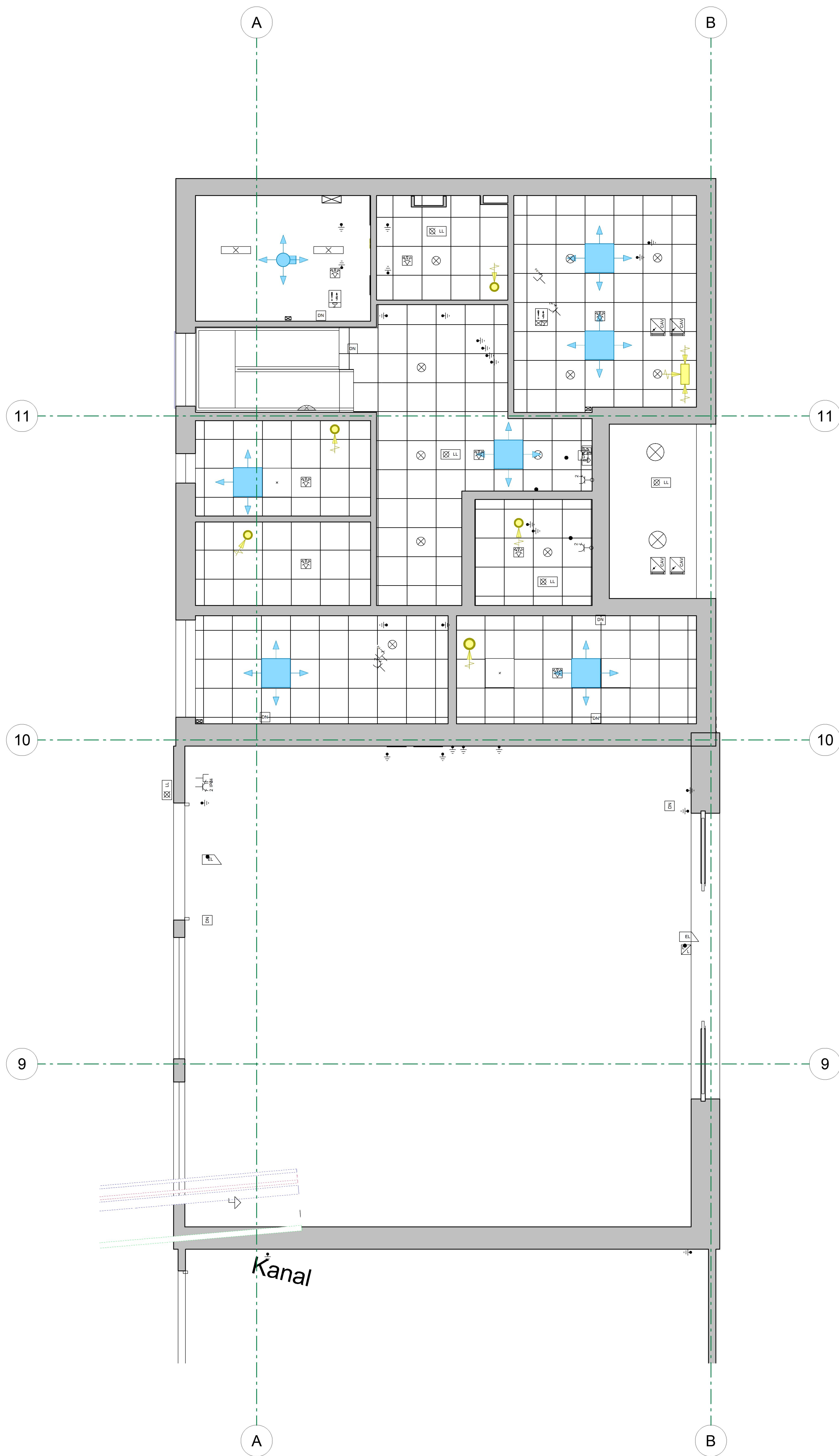

Rev	Tegn. nr	Rev.
	V-30-01-30-01-2022	

Tilbudstegning Totalentreprise		ED	SAL	09.02.23
Tilbudstegning Byggetrinn HEB		ED	SAL	04.04.22
Rev	Revideringen gjelder	Tegn.	Kontr.	Dato.
		ED		DATO
KARMØY KOMMUNE		KONTR.	SAL	DATO
P56800 - NY GJENVINNGSSTASJON BORGAREDALEN				16.02.22
Himlingsplan 1.etg Del 1		Målestokk:	1 : 50	
		Status:	TILBUDSTEGNING	
		Prosj. nr	2321	
		Tegn. nr	V-30-01-30-01-2022	
		Rev.		



Ferkingstad og Alsaker
RÅDGIVENDE INGENIØRER VVS
Karmsundgt. 159 - 5522 Haugesund - Tlf 52 70 53 80



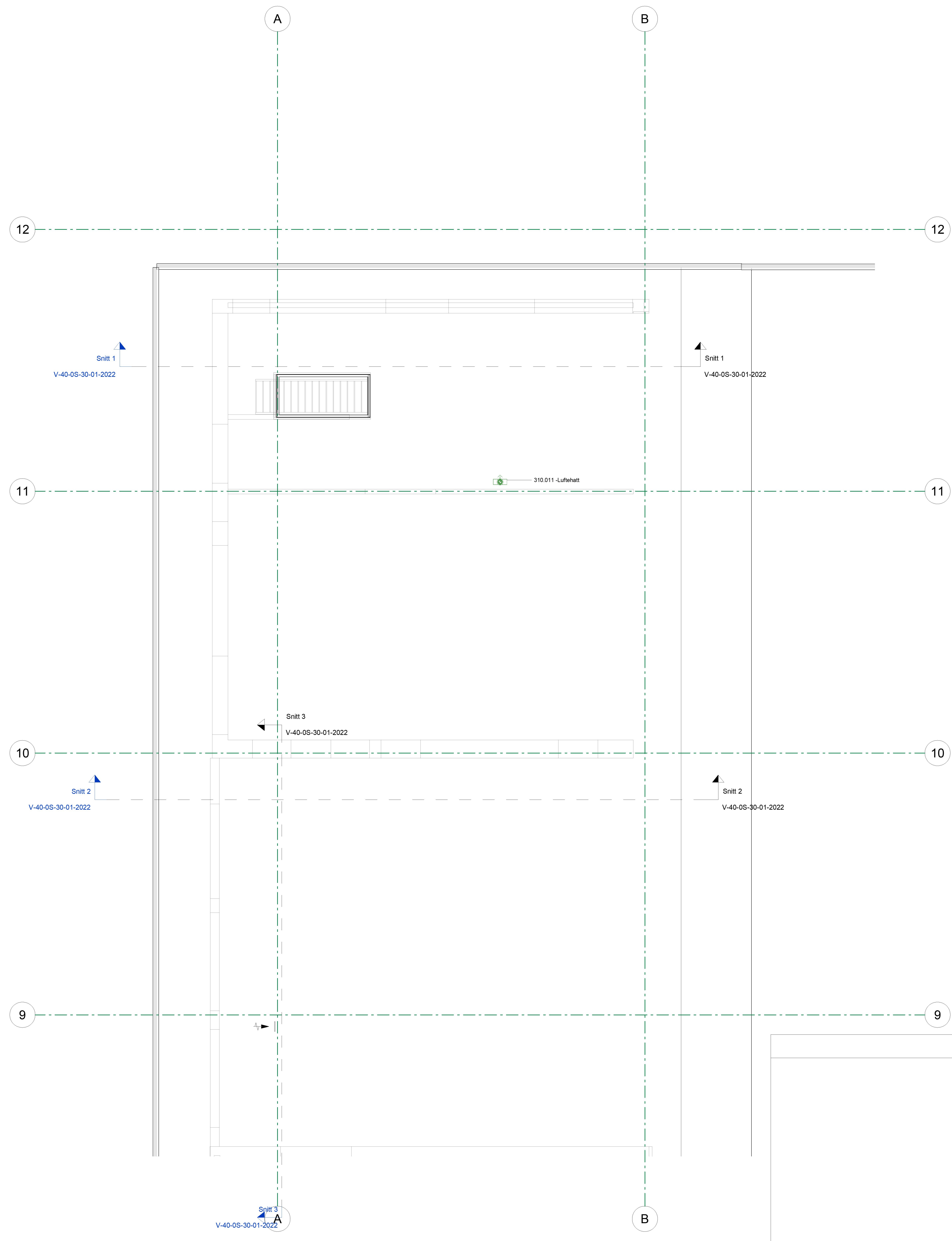

Tegn. nr	V-30-OT-30-01-2022	Rev.
----------	--------------------	------

Tilbudstegning Totalentreprise	ED	SAL	09.02.23
Tilbudstegning Byggetrinn HEB	ED	SAL	04.04.22
Rev	Revideringen gjelder	Tegn.	Kontr.
KARMØY KOMMUNE		TEGN	ED
P56800 - NY GJENVININGSSTASJON BORGAREDALEN		KONTR	SAL
Takplan Del 1		DATO	16.02.22
Målestokk:	1 : 50	Status:	TILBUDSTEGNING
Prosj nr	2321	Tegn. nr	V-30-OT-30-01-2022
Rev.		Rev.	



Ferkingstad og Alsaker
 RÅDGIVENDE INGENIØRER VVS
 Karmundgt. 159 - 5522 Haugesund - Tlf 52 70 53 80

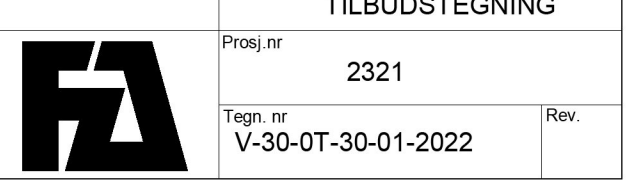

FCB/MT: (564841)

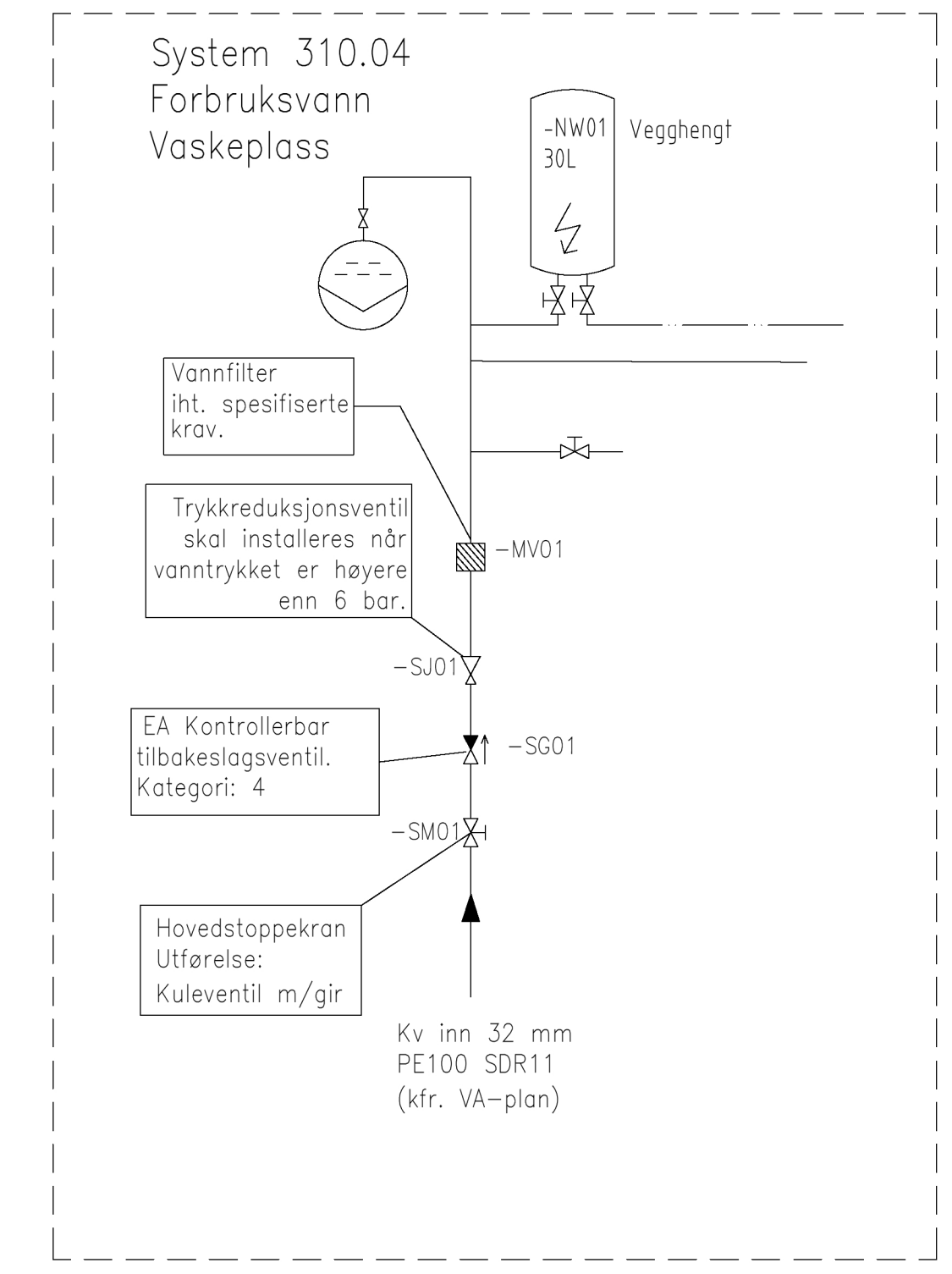
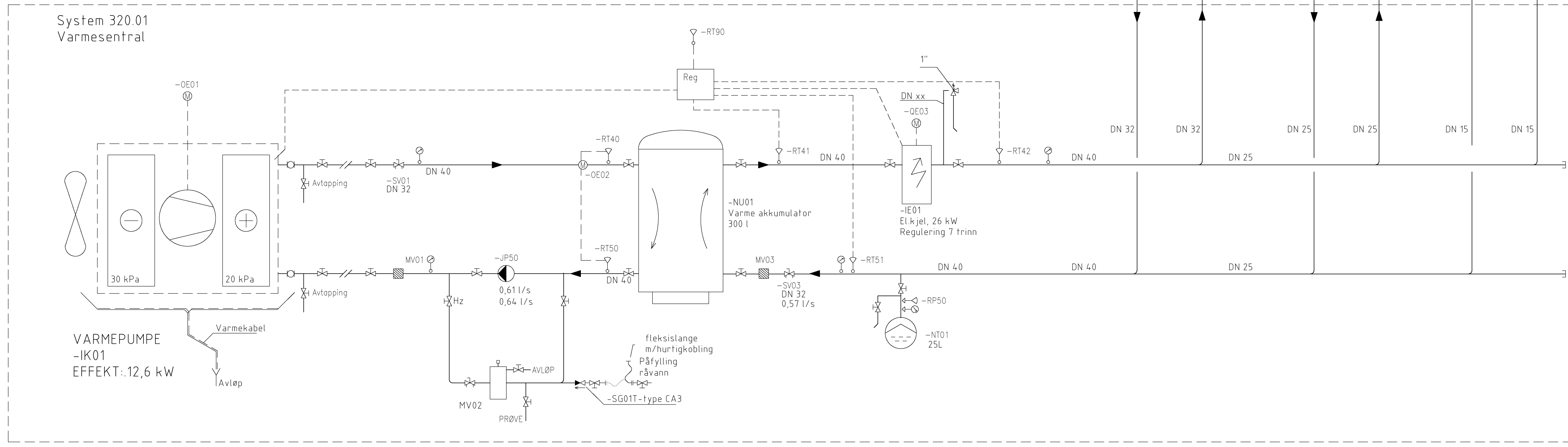
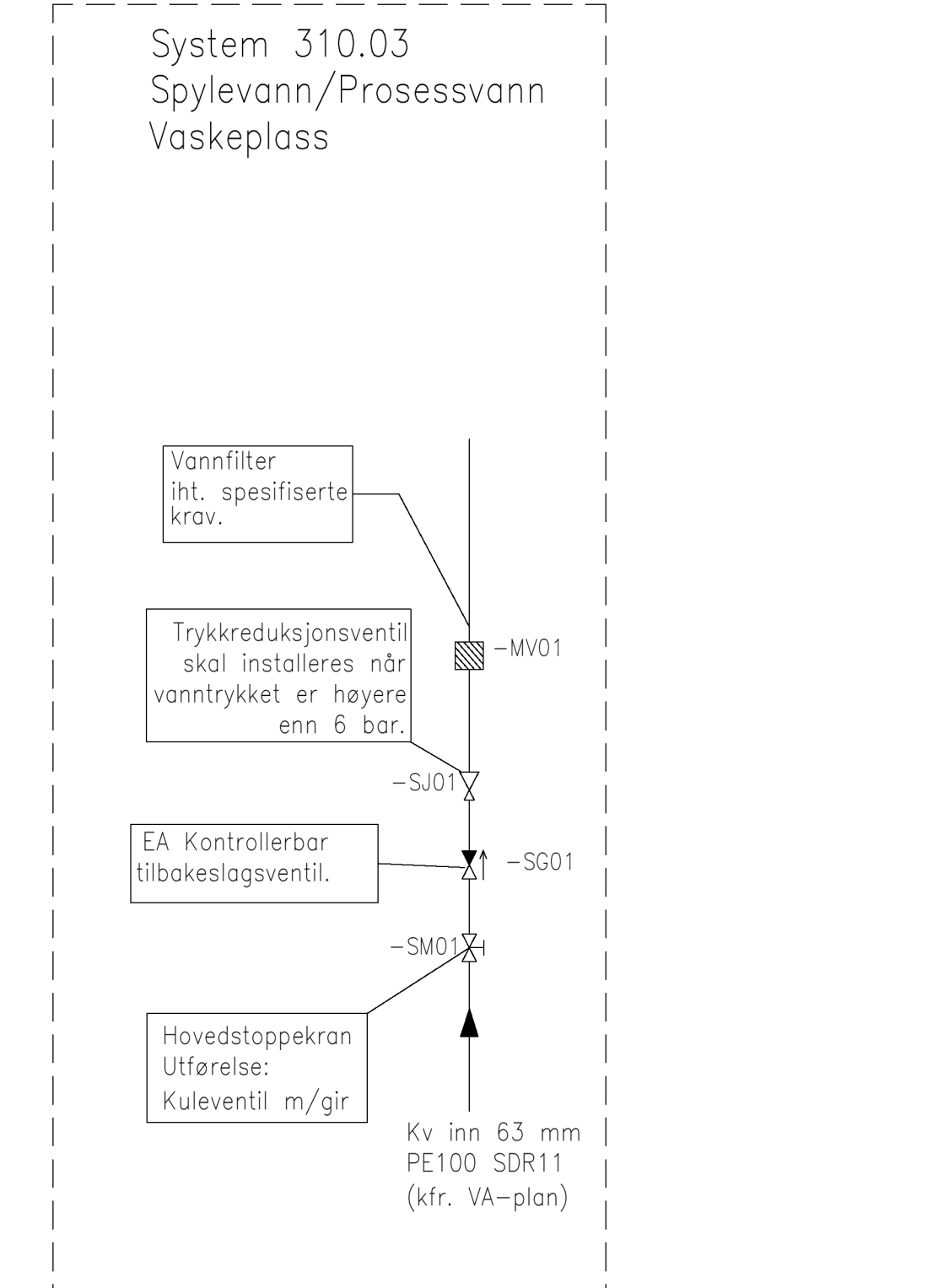
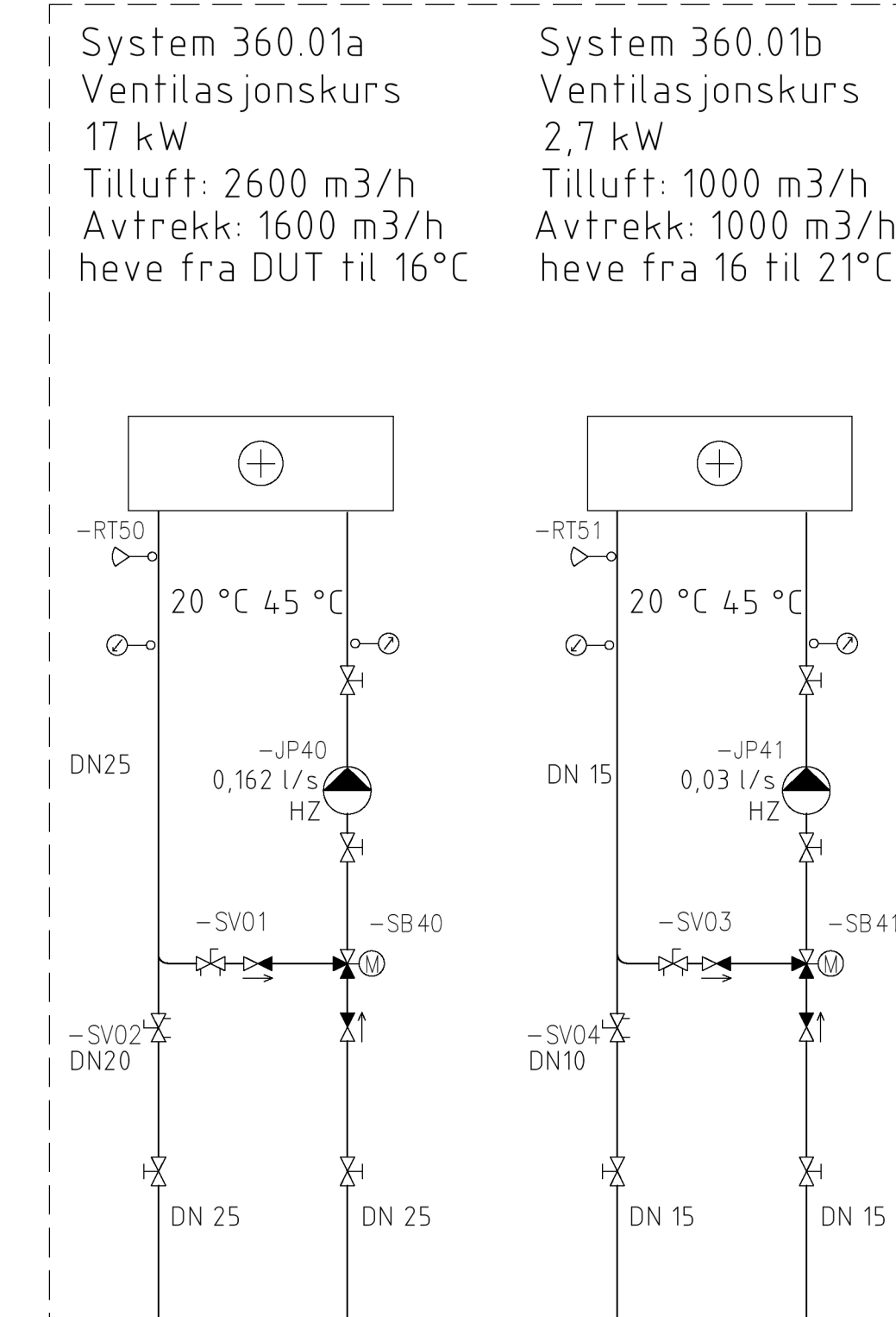
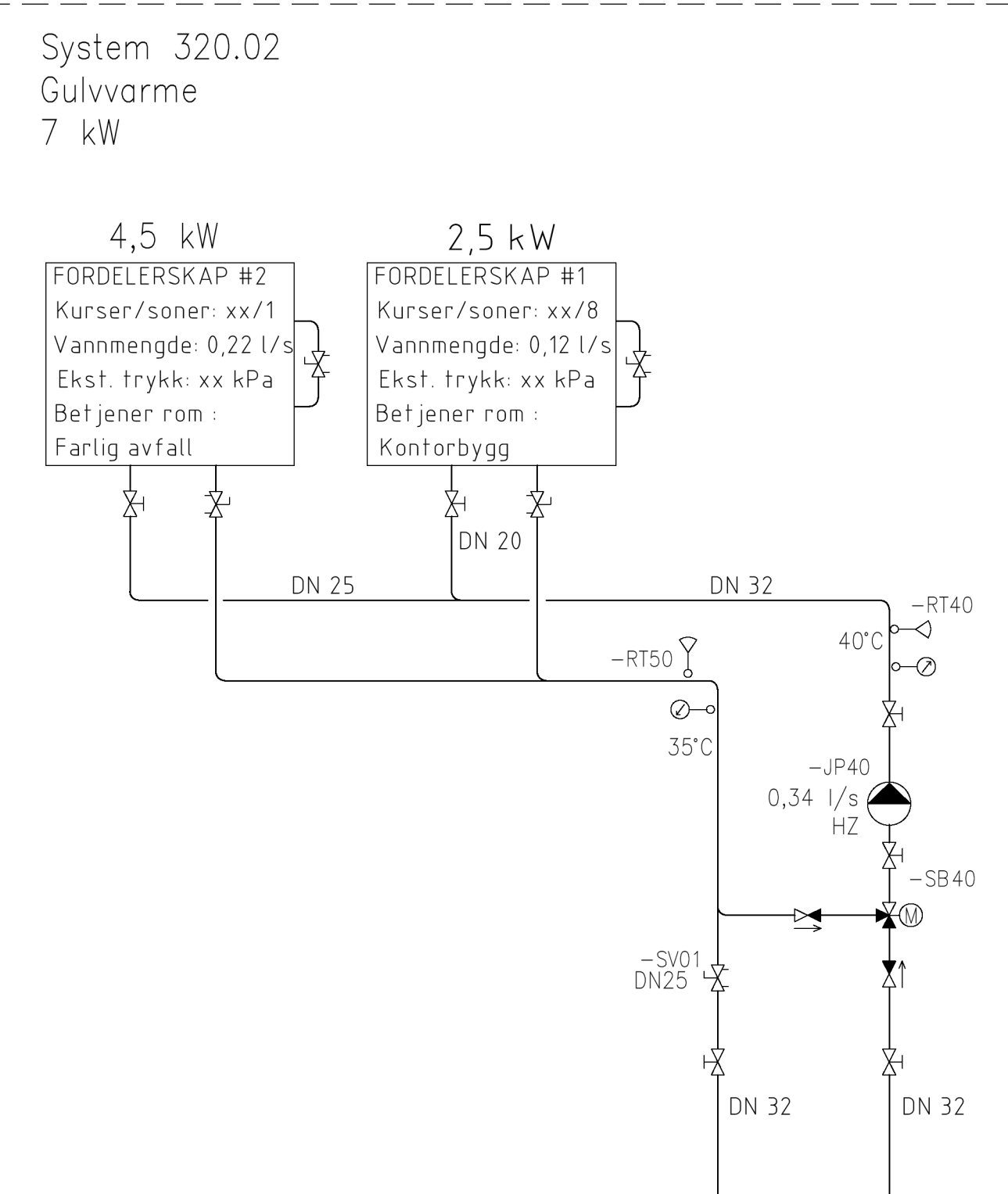
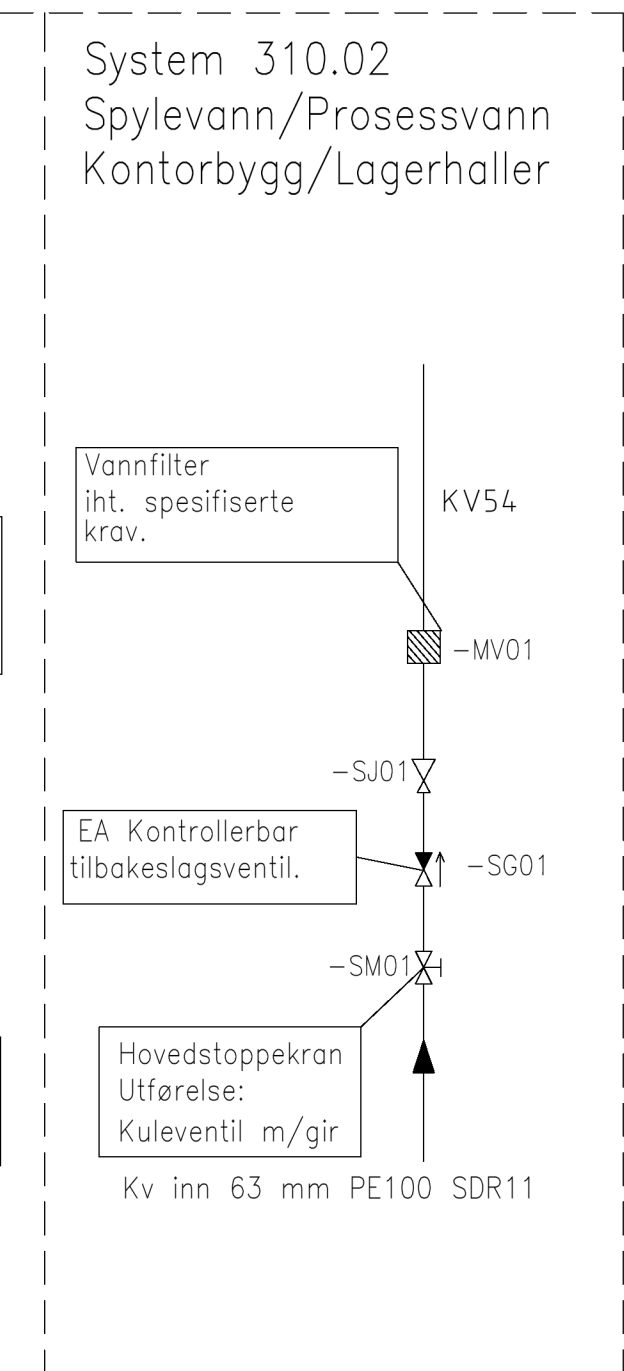
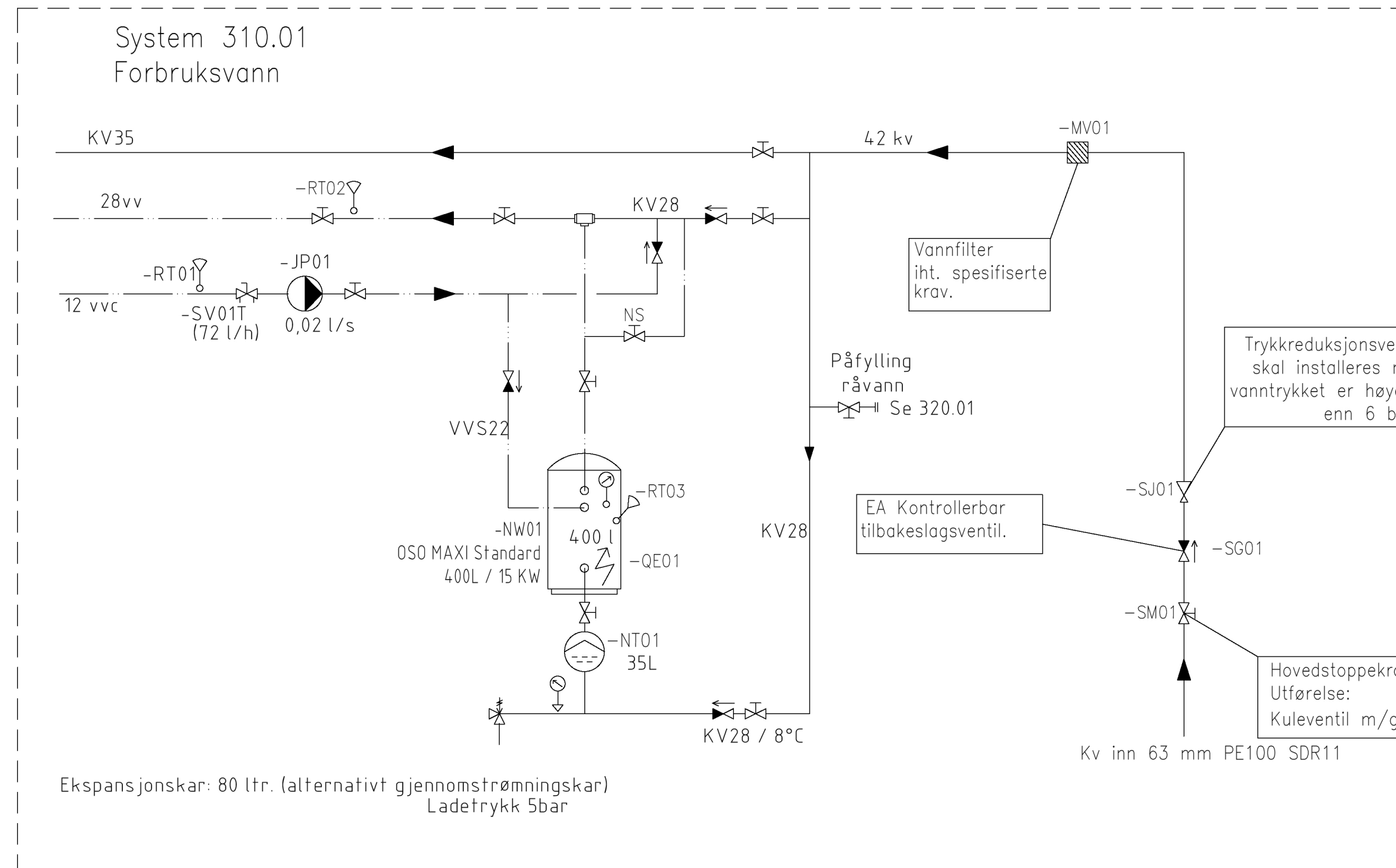
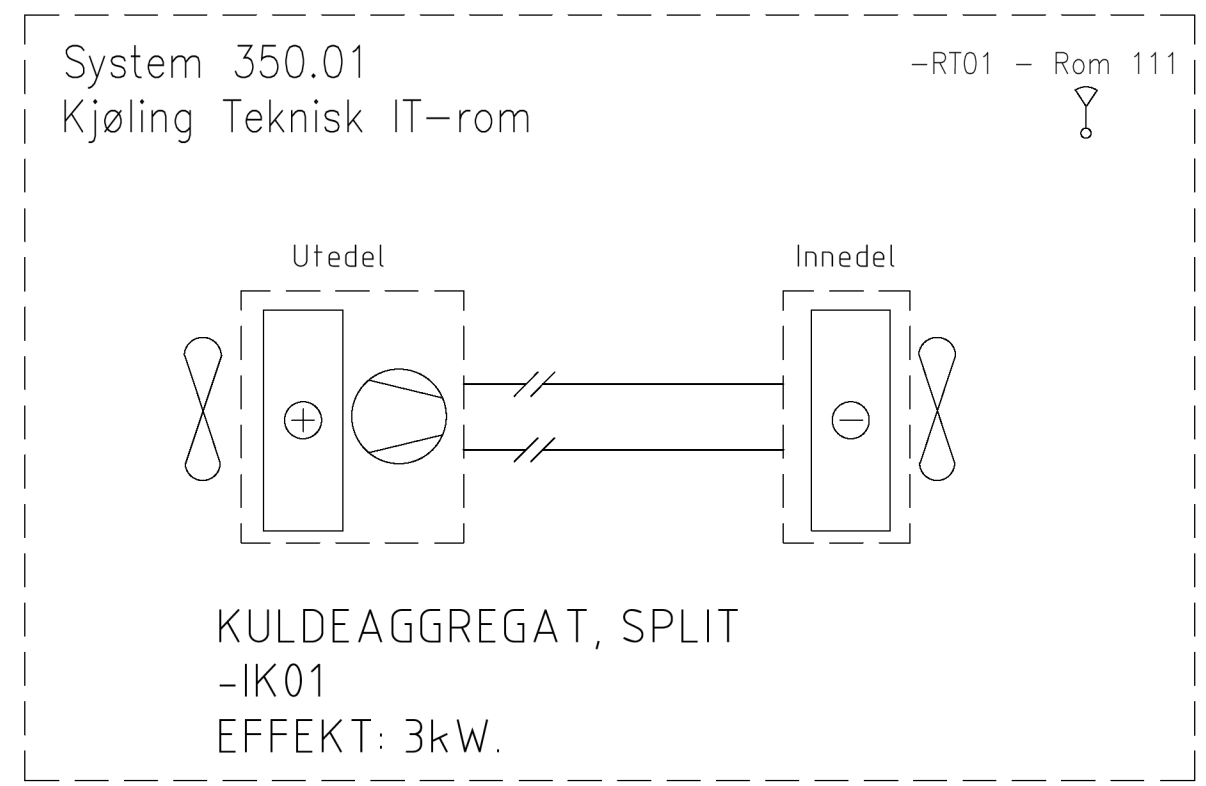
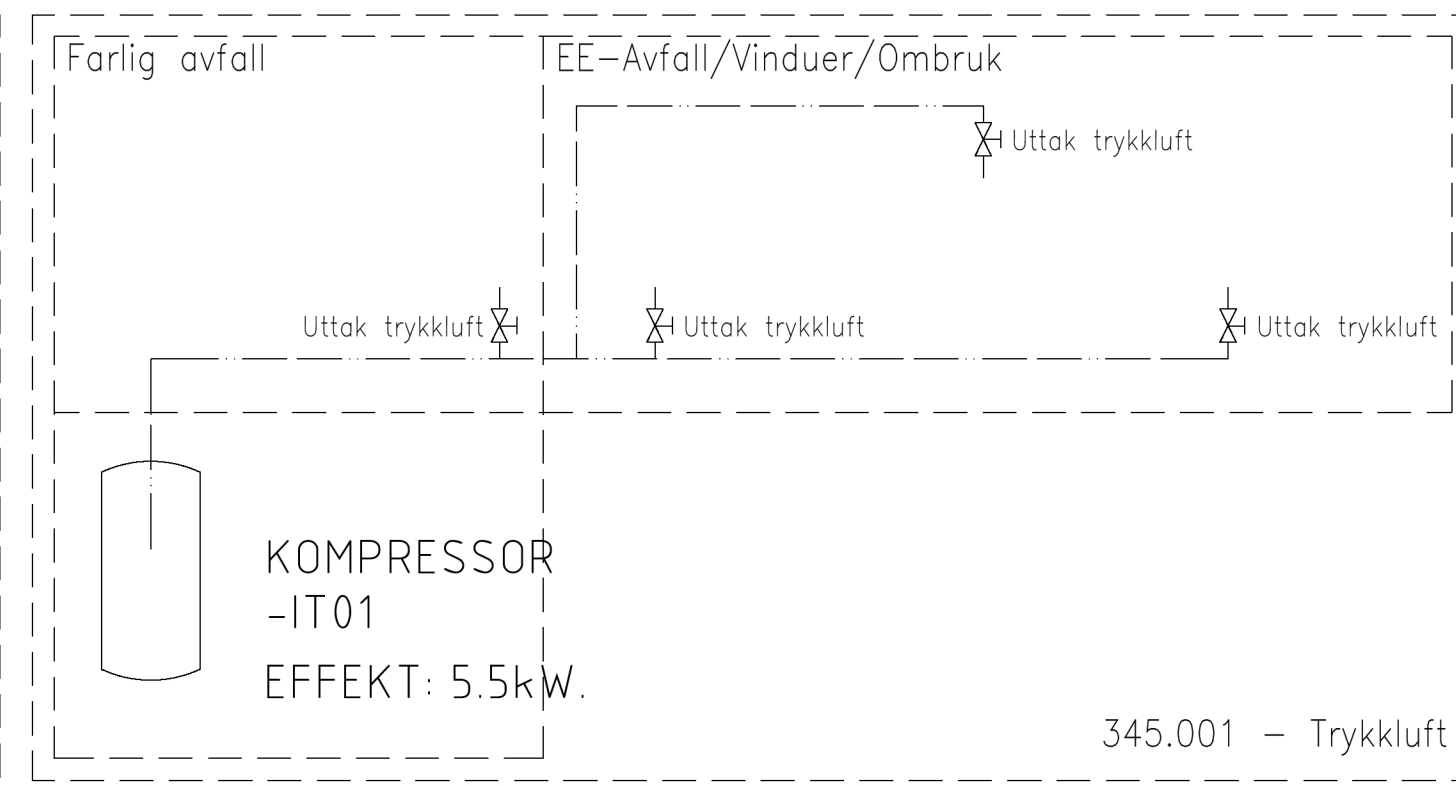
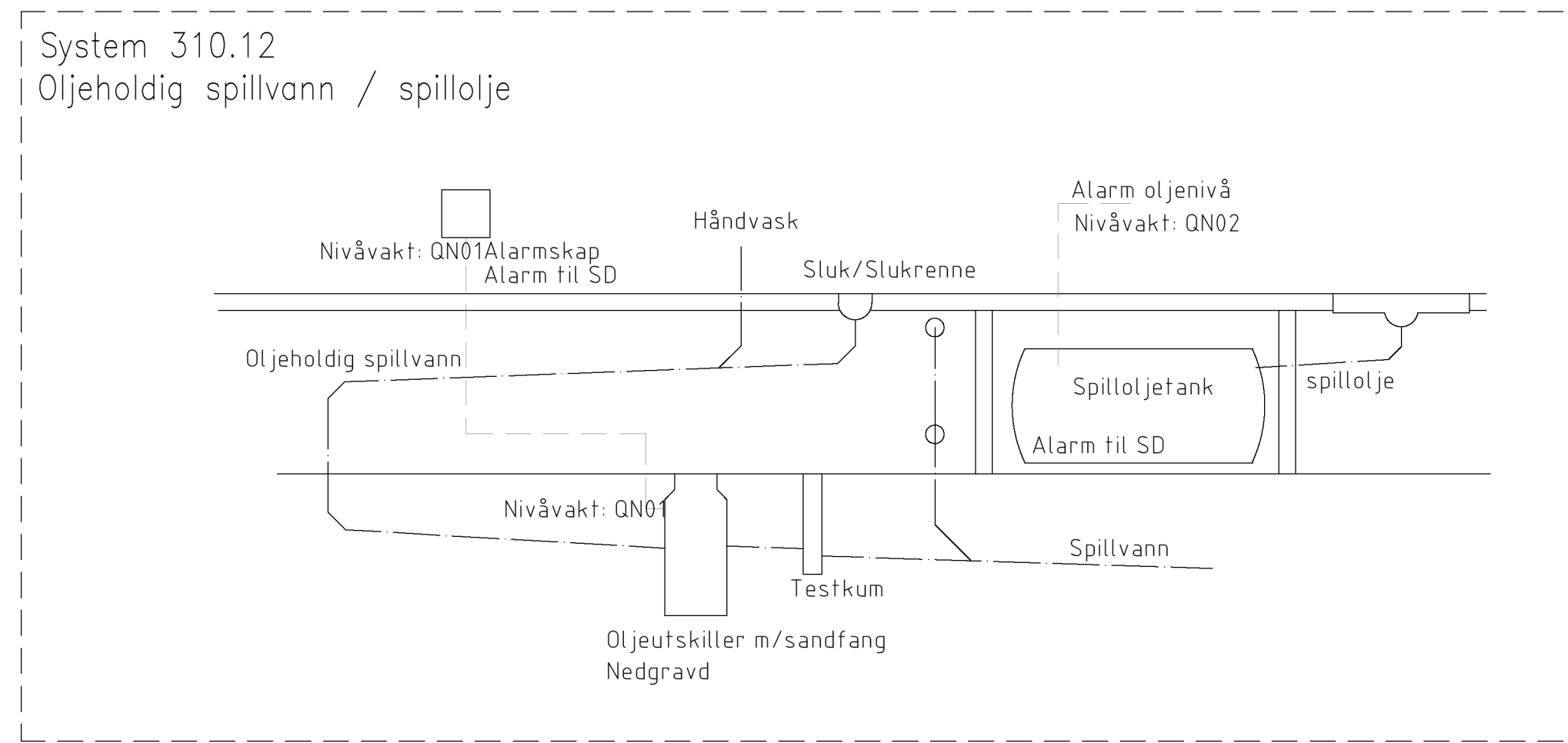

<ul style="list-style-type: none"> Avstengingsventil 2-veisventil, modulerende Trykkavhengig 2-veisventil, Åpen/stengt Trykkreduksjonsventil Tilbakeslagsventil Reguleringsventil m/målestak Trykkavhengig ventil Sikkerhetsventil 3-veisventil, modulerende Filter Kondenspøtte Vakuumventil Microbleufskiller Kompensator (CO) Fastpunkt Styring Plugg Bindlens Pumpe Tvillingpumpe 	<ul style="list-style-type: none"> Temperaturmåler (Termometer) Temperaturgiver Termostatt Trykkmåler (Manometer) Pressostat Mengdemåler Mengdegiver Strømsgiver Hastighetsgiver Fukighetsmåler Fukighetsgiver Hygrosstat Entsøgiver Motor, modulerende Motor, av/på Filtervakt CO2-føler Buskommunikasjon Energimåler (fleksibel) Temperaturgiver på tur og retur Energimåler (elektrisk) Ekspansjonskar Kjøil for fast Brensel 	<ul style="list-style-type: none"> Gassfyllt kjø Djøfyllt kjø Elek Akkumulatortank VVB - varmbrent oppvarmet VVB el. oppvarmet Varmerestler
---	---	--

Tegning nr. **V-70-0X-30-01-2022-Energianlegg**

TILBUDSTEGNING	TOTALENTPREISE	ED	09.02.23
TILBUDSTEGNING		ED	04.04.22
REV.	TEKST	SIGN.	DATE
		ED	06.09.21
KARMØY KOMMUNE		KONTROLL	SAL
P56800 - NY GJENVINNINGSTASJON BORGAREDALEN		DATE	16.02.22
SYSTEMSKJEMA ENERGIANLEGG		PROSJEKT	-
TRYKKLUFT, KJØLING, FORBRUKSVANN OG OLJEHOLDIG SPILLVANN		PROSJEKT	2321
Ferkingsstad og Alsaker		TEGNER	V-70-0X-30-01-2022
RÅDGIVENDE INGENIØRER VVS		REV.	
Karmøysgt 58 - 5522 Haugesund - Tlf 52 70 53 60 - Fax 52 70 53 66			



f:\prosjekt\karmøy kommune\borgaredalen renovasjon\12 tegninger\skjema\2321-systemskjema.dwg

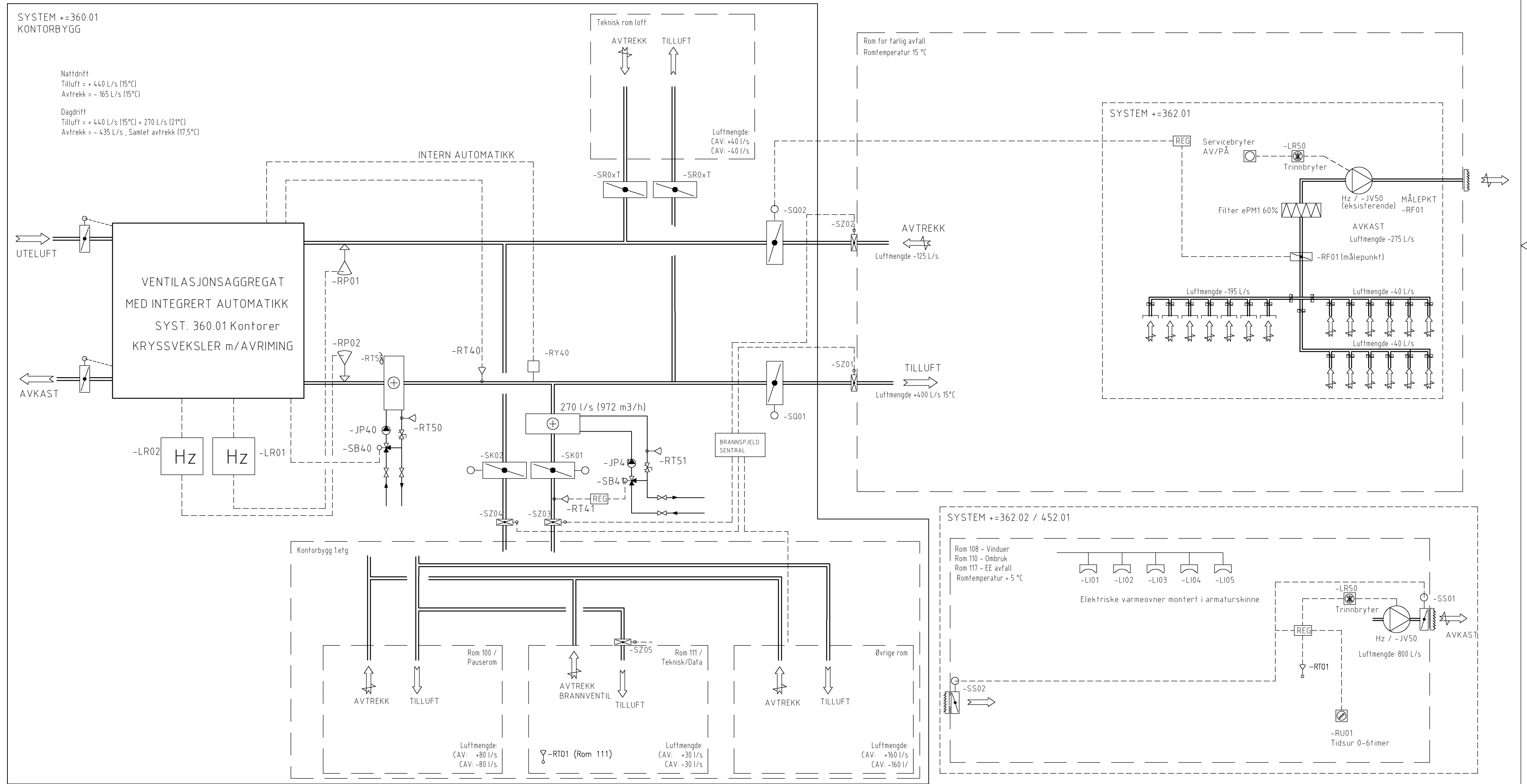

	TILBUDSTEGNING TOTALENTREPRISE	ED	09.02.23
	TILBUDSTEGNING	ED	04.04.22
REV.	TEKST	SIGN.	DATO
	KARMØY KOMMUNE	TEGN.	ED
	P56800 - NY GJENVINNGSSTASJON BORGAREDALEN	KONTR.	SAL
	SYSTEMSKJEMA VENTILASJONSANLEGG 360.01 / 362.01 / 362.02	DATO	16.02.22
		GODKJ.	DATO
		Målestokk:	-
		Prosj.nr	2321
		Tegn. nr	V-70-0X-30-02-2022
		Rev.	

