

## Flow Measurement

### SITRANS F M

#### Flow sensor MAG 5100 W

##### Overview



The SITRANS F M MAG 5100 W is an electromagnetic flow sensor designed to meet ground water, drinking water, waste water, sewage or sludge applications.

##### Benefits

- DN 15 to DN 1200/2000 (1/2" to 48"/78")
- Stock program of MAG 5100 W secures short delivery time
- Connection flanges EN 1092-1 (DIN 2501), ANSI, AWWA, AS and JIS.
- NBR Hard Rubber and Ebonite Hard Rubber liner for all water applications
- EPDM liner with drinking water approvals
- Hastelloy integrated grounding and measuring electrodes
- Increased low flow accuracy for water leak detection, due to coned liner design.
- Drinking water approvals
- Suitable for direct burial and constant flooding
- Custody transfer approvals
- Built-in length according to ISO 13359; the standard includes sizes up to DN 400.
- Easy commissioning, SENSORPROM unit automatically uploads calibration values and settings.
- Designed so patented in-situ verification can be conducted. Using SENSORPROM fingerprint.
- Custody transfer option for water billing, with type approval after OIML R 49 and verified according to MI-001 - OD inlet/OD outlet installation
  - Pattern approval OIML R 49
  - Conform to ISO 4064 and EN 14154 for mechanical flowmeters
  - PTB K7.2
  - Kiwa water approval
- FM Fire Service Meter (Class Number 1044) for automatic fire protection systems
- Meets EEC directives: PED 2014/68/EU pressure directive for EN1092-1 flanges
- Simple onsite or factory upgrade to IP68/NEMA 6P of a standard sensor
- Type approval of marine equipment (ABS, Bureau Veritas, DNV, GL, Lloyd's Register)

##### Application

The main applications of the SITRANS F M electromagnetic flow sensors can be found in the following fields:

- Water abstraction
- Water treatment
- Water distribution network (leak detection management)
- Custody transfer water meters
- Irrigation
- Waste water treatment
- Filtration plant (e.g. reverse osmosis and ultra filtration)
- Industrial water applications

##### Mode of operation

The flow measuring principle is based on Faradays law of electromagnetic induction according to which the sensor converts the flow into an electrical voltage proportional to the velocity of the flow.

##### Integration

The complete flowmeter consists of a flow sensor and an associated transmitter SITRANS F M MAG 5000, MAG 6000 or MAG 6000 I.

The flexible communication concept USM II simplifies integration and update to a variety of fieldbus systems, e.g. HART, DeviceNet, PROFIBUS DP and PA, FOUNDATION Fieldbus H1 or Modbus RTU/RS 485.

## Technical specifications

Product characteristic	MAG 5100 W (7ME6520) Mainly for the European market EPDM or NBR lining	MAG 5100 W (7ME6580) Mainly for the non-European market Ebonite lining
Design and nominal size	Coned sensor (octagon liner): DN 15 ... 40 (½" ... 1½") Coned sensor: DN 50 ... 300 (2" ... 12") Full bore sensor: DN 350 ... 1200 (14" ... 48")	Full bore sensor: DN 25 ... 2000 (1" ... 78")
<b>Measuring principle</b>	Electromagnetic induction	Electromagnetic induction
Excitation frequency (Mains supply: 50/60 Hz)	DN 15 ... 65 (½" ... 2½"): 12,5 Hz/15 Hz DN 80 ... 150 (3" ... 6"): 6,25 Hz/7,5 Hz DN 200 ... 300 (8" ... 12"): 3,125 Hz/3,75 Hz DN 350 ... 1200 (14" ... 48"): 1,5625 Hz/1,875 Hz	DN 25 ... 65 (1" ... 2½"): 12,5 Hz/15 Hz DN 80 ... 150 (3" ... 6"): 6,25 Hz/7,5 Hz DN 200 ... 1200 (8" ... 48"): 3,125 Hz/3,75 Hz DN 1400 ... 2000 (54" ... 78"): 1,5625 Hz/1,875 Hz
<b>Process connection</b>		
Flanges <sup>1)</sup>		
• EN 1092-1	PN 10 (145 psi) : DN 200 ... 300 (8" ... 12") Flat face PN 10 (145 psi): DN 350 ... 1200 (14" ... 48") Raised face <sup>2)</sup> PN 16 (232 psi): DN 50 ... 300 (2" ... 12") Flat face <sup>3)</sup> PN 16 (232 psi): DN 350 ... 1200 (14" ... 48") Raised face PN 40 (580 psi): DN 15 ... 40 (½" ... 1½") Flat face	Raised face <sup>3)</sup> (EN 1092-1, DIN 2501 and BS 4504 have the same mating dimensions) PN 6 (87 psi): DN 1400 ... 2000 (54" ... 78") PN 10 (145 psi): DN 200 ... 2000 (8" ... 78") PN 16 (232 psi): DN 65 ... 600 (2½" ... 24") PN 40 (580 psi): DN 25 ... 50 (1" ... 2")
• ANSI B16.5	Class 150: ½" ... 12" Flat face; 14" ... 24" Raised face	Class 150: 1" ... 24"; Raised face
• AWWA C-207	Class D: 28" ... 48", Flat face	Class D: 28" ... 78", Flat face
• AS4087	PN 16 (232 psi): DN 15 ... DN 300 (2" ... 12") Flat Face; DN 350 ... DN 1200 (14" ... 48") Raised face	PN 16 (232 psi): DN 50 ... DN 1200 (2" ... 48") Raised face
• JIS B 2220:2004	-	K10 (1" ... 24")
<b>Rated Operation conditions</b>		
Ambient temperature		
• Sensor	-40 ... +70 °C (-40 ... +158 °F)	-20 ... +70 °C (-4 ... +158 °F)
• Compact with transmitter MAG 5000/6000 <sup>4)</sup>	-20 ... +60 °C (-4 ... +140 °F)	-20 ... +60 °C (-4 ... +140 °F)
Operating pressure (Abs) [abs. bar] (Maximum operating pressure depending on flange standard, decreases with increasing operating temperature)	DN 15 ... 40 (½" ... 1½"): 0,01 ... 40 bar (0,15 ... 580 psi) DN 50 ... 300 (2" ... 12"): 0,03 ... 20 bar (0,44 ... 290 psi) DN 350 ... 1200 (14" ... 48"): 0,01 ... 16 bar (0,15 ... 232 psi)	DN 25 ... 50 (1" ... 2"): 0,01 ... 40 bar (0,15 ... 580 psi) DN 65 ... 1200 (2½" ... 48"): 0,01 ... 16 bar (0,15 ... 232 psi) DN 1400 ... 2000 (54" ... 78"): 0,01 ... 10 bar (0,15 ... 145 psi)
Enclosure rating		
• Standard	IP67 to EN 60529/NEMA 4X/6 (1 mH <sub>2</sub> O for 30 min)	IP67 to EN 60529/NEMA 4X/6 (1 mH <sub>2</sub> O for 30 min)
• Option	IP68 to EN 60529/NEMA 6P (10 mH <sub>2</sub> O continuously)	IP68 to EN 60529/NEMA 6P (10 mH <sub>2</sub> O continuously)
Pressure drop	DN 15 and 25 (½" and 1"): Max. 20 mbar (0,29 psi) at 1 m/s (3 ft/s). DN 40 ... 300 (1½" ... 12"): Max 25 mbar (0,36 psi) at 3 m/s (10 ft/s) DN 350 ... 1200 (14" ... 48"): Insignificant	Insignificant
Test pressure	1,5 x PN (where applicable) FM Fire Service: 2 x PN	1,5 x PN (where applicable)
Mechanical load (vibration)	18 ... 1000 Hz random in x, y, z, directions for 2 hours according to EN 60068-2-36 Sensor: 3,17 g RMS Sensor with compact MAG 5000/6000 mounted transmitter: 3,17 g RMS Sensor with compact MAG 6000 I mounted transmitter: 1,14 g RMS	18 ... 1000 Hz random in x, y, z, directions for 2 hours according to EN 60068-2-36 Sensor: 3,17 g RMS Sensor with compact MAG 5000/6000 mounted transmitter: 3,17 g RMS Sensor with compact MAG 6000 I mounted transmitter: 1,14 g RMS

## Flow Measurement

### SITRANS F M

#### Flow sensor MAG 5100 W

Product characteristic	Mainly for the European market (7ME6520)	Mainly for the non-European market (7ME6580)
	EPDM or NBR lining	Ebonite lining
<u>Medium conditions</u>		
Temperature of medium		
• NBR	-10 ... +70 °C (14 ... 158 °F)	-
• EPDM	-10 ... +70 °C (14 ... 158 °F)	-
• EPDM/NBR (MI-001)	0,1 ... 30 °C (32 ... 76 °F)	-
• Ebonite	-	-10 ... +70 °C (14 ... 158 °F)
EMC	2014/30/EU	2014/30/EU
<b>Design</b>		
Material		
• Housing and flanges	Carbon steel ASTM A 105, with corrosion-resistant coating Corrosivity category C4M, according to ISO 12944-2	Carbon steel ASTM A 105, with corrosion-resistant coating Corrosivity category C4M, according to ISO 12944-2
• Electrode	Hastelloy C276	Hastelloy C276
• Grounding electrode	Hastelloy C276	Hastelloy C276
• Terminal box	Fibre glass reinforced polyamide	Fibre glass reinforced polyamide
<b>Certificates and approvals</b>		
Calibration		
• Standard production calibration	Zero-point, 2 x 25 % and 2 x 90 %	Zero-point, 2 x 25 % and 2 x 90 %
• Special calibration	5-point calibration: 20 %, 40 %, 60 %, 80 %, 100 % of factory Q <sub>max</sub> 10-point calibration: ascending and descending at 20 %, 40 %, 60 %, 80 %, 100 % of factory Q <sub>max</sub> Matched-pair calibration: default, 5-point or 10-point	5-point calibration: 20 %, 40 %, 60 %, 80 %, 100 % of factory Q <sub>max</sub> 10-point calibration: ascending and descending at 20 %, 40 %, 60 %, 80 %, 100 % of factory Q <sub>max</sub> Matched-pair calibration: default, 5-point or 10-point
Custody transfer	<ul style="list-style-type: none"> <li>• MI-001 cold water (EU): DN 50 ... DN 1200 (2" ... 48")</li> <li>• Kiwa water approval (NL): DN 50 ... DN 1200 (2" ... 48")</li> <li>• Chilled water pattern approval PTB K 7.2 DN 50 ... DN 300 (Germany)<sup>5)</sup></li> </ul>	-
Drinking water	EPDM liner: <ul style="list-style-type: none"> <li>• WRAS (WRc, BS690 cold water, GB)</li> <li>• NSF/ANSI Standard 61<sup>6)</sup> (Cold water, US)</li> <li>• ACS listed (F)</li> <li>• DVGW W270 (D)</li> <li>• Belgaqua (B)</li> <li>• MCERTS (GB environmental)</li> </ul>	<ul style="list-style-type: none"> <li>• WRAS (WRc, BS690 cold water, GB)</li> <li>• NSF/ANSI Standard 61<sup>6)</sup> (Cold water, US)</li> </ul>
Marine <sup>7)</sup>	<ul style="list-style-type: none"> <li>• American Bureau of Shipping (ABS)</li> <li>• Bureau Veritas</li> <li>• Det Norske Veritas (DNV)</li> <li>• Germanischer Lloyd (GL)</li> <li>• Lloyd's Register of Shipping</li> </ul>	
Hazardous areas <sup>8)</sup>		
• Standard sensor with/without MAG 5000/6000/6000 I	<ul style="list-style-type: none"> <li>• FM</li> <li>- NI Class I Div. 2 Groups A, B, C, D</li> <li>- NI Class I Zone 2 Groups IIC</li> </ul>	<ul style="list-style-type: none"> <li>• FM</li> <li>- NI Class I Div. 2 Groups A, B, C, D</li> <li>- NI Class I Zone 2 Groups IIC</li> </ul>
Pressure equipment	<ul style="list-style-type: none"> <li>• PED conforming: All EN1092-1 flanges and ANSI Class 150 (&lt; DN 300 /&lt;24") – 2014/68/EU<sup>9)</sup></li> <li>• CRN</li> </ul>	<ul style="list-style-type: none"> <li>• PED conforming: All EN1092-1 flanges (&lt; DN 600 /&lt;24") – 2014/68/EU<sup>9)</sup></li> <li>• CRN</li> </ul>
Others	<ul style="list-style-type: none"> <li>• EAC (Russia, Belarus, Kazakhstan)</li> <li>• KCC (South Korea)</li> <li>• FM Fire Service Approval acc. to class 1044<sup>8)</sup></li> <li>• VdS: Extinguishing systems DN 50 ... 300</li> </ul>	<ul style="list-style-type: none"> <li>• EAC (Russia, Belarus, Kazakhstan)</li> <li>• CMC/CPA (China)</li> </ul>

1) DN 750, DN 1050 and DN 1100 (30", 42" and 44") not available with EN 1092-1 (PN 10 and PN 16) and AS4087 flanges

2) Type 01 (SORF)

3) DN ≤ 600 type 01 (SORF); DN > 600 type 11

4) Compact with transmitter MAG 5000 CT/6000 CT -20 ... +50 °C (-4 ... +122 °F)

5) For verification submit Product Variation Request

6) Including Annex G

7) In remote version with sensor size DN 50 ... DN 300 (2" ... 12")

8) For sizes larger than 600 mm (24") in PN 16 PED conformity is available as a cost-added option. The basic unit will carry the LVD (Low Voltage Directive) and EMC approval. All products sold outside of EU and EFTA are excluded from the directive, also products sold into certain market sectors are excluded. These include:

a) Meters used in networks for the supply, distribution and discharge of water.

b) Meters used in pipelines for the conveyance of any fluid from offshore to onshore.

c) Meters used in the extraction of petroleum or gas, including Christmas tree and manifold equipment.

d) Any meter mounted on a ship or mobile offshore platform. For further information on the PED standard and requirements see page 10/15.

9) Not for sensors with 300 µm coating.

**MAG 5100 W (7ME6520) with MAG 6000 CT (Revenue program) MI-001**

MAG 5100 W CT program is type approved according to international water meter standard OIML R 49. Since the first November 2006 the MI-001 water meter directive is in force, which means that all water meters can be sold across the EU borders if the water meters contain a MI-001 label.

The MAG 5100 W MI-001 verified and labeled products are a Class II approval according to Directive 2014/32/EU of the European Parliament and Council of 26 February, 2014 on measuring instruments, Annex VI Thermal Energy Meters (MI-004) in the sizes from DN 50 to DN 1200 (Article No. 7ME6520).

The MID certification is obtained as a modul B + D module approval according to the above mentioned directive.

Module B : Type approval according to OIML R 49

Module D : Quality insurance approval of production

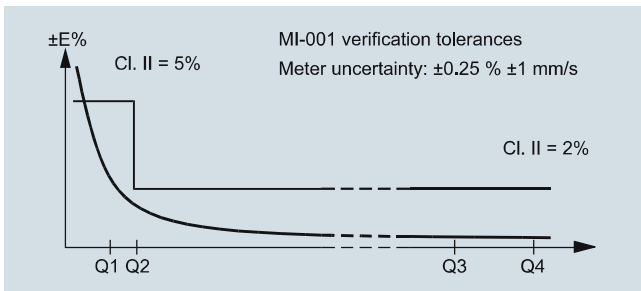

**MAG 5100 W (7ME6520) with MAG 5000/MAG 6000 or MAG 6000 CT for Fire Service applications**

MAG 5100 W (7ME6520) is FM Fire Service approved for automatic fire protection systems. The approval is applicable for the sizes DN 50, DN 80, DN 100, DN 150, DN 200, DN 250 and DN 300 (2", 3", 4", 6", 8", 10" and 12") with ANSI B16.5 Class 150 flanges. The FM Fire Service approved product can be ordered via the Z-options P20, P21 and P22.

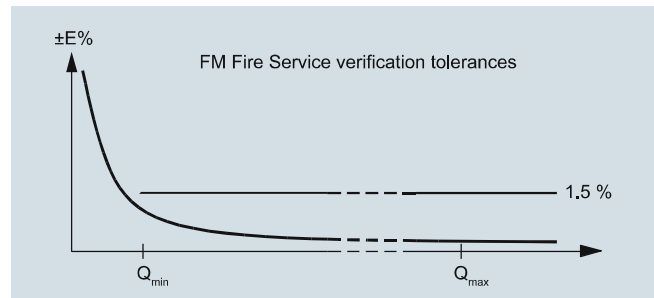

3

## Flow Measurement

### SITRANS F M

#### Flow sensor MAG 5100 W

MAG 5100 W (7ME6520) MI-001 verified and labeled products at a given Q3 and Q3/Q4 = 1.25 and Q2/Q1 = 1.6 measuring ranges see table below:

Order code: P11	DN 50 (2")	DN 65 (2½")	DN 80 (3")	DN 100 (4")	DN 125 (5")	DN 150 (6")	DN 200 (8")	DN 250 (10")	DN 300 (12")
„R“ Q3/Q1	40	40	40	40	40	40	40	40	40
Q4 [m³/h]	20	31.25	50	78.75	125	200	312.5	500	787.5
<b>Q3 [m³/h]</b>	<b>16</b>	<b>25</b>	<b>40</b>	<b>63</b>	<b>100</b>	<b>160</b>	<b>250</b>	<b>400</b>	<b>630</b>
Q2 [m³/h]	0.64	1.0	1.6	2.52	4.0	6.4	10.0	16.0	25.2
Q1 [m³/h]	0.4	0.63	1.0	1.58	2.5	4.0	6.25	10.0	15.75

Order code: P12	DN 50 (2")	DN 65 (2½")	DN 80 (3")	DN 100 (4")	DN 125 (5")	DN 150 (6")	DN 200 (8")	DN 250 (10")	DN 300 (12")
„R“ Q3/Q1	63	63	63	63	63	63	63	63	63
Q4 [m³/h]	20	31.25	50	78.75	125	200	312.5	500	787.5
<b>Q3 [m³/h]</b>	<b>16</b>	<b>25</b>	<b>40</b>	<b>63</b>	<b>100</b>	<b>160</b>	<b>250</b>	<b>400</b>	<b>630</b>
Q2 [m³/h]	0.41	0.63	1.02	1.6	2.54	4.06	6.35	10.2	16.0
Q1 [m³/h]	0.25	0.40	0.63	1.00	1.59	2.54	3.97	6.35	10.0

Order code: P13	DN 50 (2")	DN 65 (2½")	DN 80 (3")	DN 100 (4")	DN 125 (5")	DN 150 (6")	DN 200 (8")	DN 250 (10")	DN 300 (12")
„R“ Q3/Q1	80	80	80	80	80	80	80	80	80
Q4 [m³/h]	20	31.25	50	78.75	125	200	312.5	500	787.5
<b>Q3 [m³/h]</b>	<b>16</b>	<b>25</b>	<b>40</b>	<b>63</b>	<b>100</b>	<b>160</b>	<b>250</b>	<b>400</b>	<b>630</b>
Q2 [m³/h]	0.32	0.5	0.8	1.26	2.0	3.2	5.0	8.0	12.6
Q1 [m³/h]	0.20	0.31	0.50	0.79	1.25	2.00	3.13	5.00	7.9

Order code: P16	DN 50 (2")	DN 65 (2½")	DN 80 (3")	DN 100 (4")	DN 125 (5")	DN 150 (6")	DN 200 (8")	DN 250 (10")	DN 300 (12")
„R“ Q3/Q1	100	100	100	100	100	100	100	100	100
Q4 [m³/h]	50	78.75	125	200	312.5	500	787.5	1250	2000
<b>Q3 [m³/h]</b>	<b>40</b>	<b>63</b>	<b>100</b>	<b>160</b>	<b>250</b>	<b>400</b>	<b>630</b>	<b>1000</b>	<b>1600</b>
Q2 [m³/h]	0.64	1.01	1.6	2.56	4.0	6.4	10.08	16.0	25.6
Q1 [m³/h]	0.4	0.63	1.0	1.6	2.5	4.0	6.3	10.0	16.0

Order code: P17	DN 50 (2")	DN 65 (2½")	DN 80 (3")	DN 100 (4")	DN 125 (5")	DN 150 (6")	DN 200 (8")	DN 250 (10")	DN 300 (12")
„R“ Q3/Q1	200	200	200	200	200	200	200	200	200
Q4 [m³/h]	50	78.75	125	200	312.5	500	787.5	1250	2000
<b>Q3 [m³/h]</b>	<b>40</b>	<b>63</b>	<b>100</b>	<b>160</b>	<b>250</b>	<b>400</b>	<b>630</b>	<b>1000</b>	<b>1600</b>
Q2 [m³/h]	0.32	0.50	0.80	1.28	2.0	3.2	5.0	8.0	12.8
Q1 [m³/h]	0.2	0.32	0.5	0.8	1.25	2.0	3.15	5.0	8.0

Order code: P18	DN 50 (2")	DN 65 (2½")	DN 80 (3")	DN 100 (4")	DN 125 (5")	DN 150 (6")	DN 200 (8")	DN 250 (10")	DN 300 (12")
„R“ Q3/Q1	250	250	250	250	250	250	250	250	250
Q4 [m³/h]	50	78.75	125	200	312.5	500	787.5	1250	2000
<b>Q3 [m³/h]</b>	<b>40</b>	<b>63</b>	<b>100</b>	<b>160</b>	<b>250</b>	<b>400</b>	<b>630</b>	<b>1000</b>	<b>1600</b>
Q2 [m³/h]	0.26	0.4	0.64	1.02	1.6	2.56	4.0	6.4	10.24
Q1 [m³/h]	0.16	0.25	0.4	0.64	1.0	1.6	2.52	4.0	6.4

Order code: P19	DN 50 (2")	DN 65 (2½")	DN 80 (3")	DN 100 (4")	DN 125 (5")	DN 150 (6")	DN 200 (8")	DN 250 (10")	DN 300 (12")
„R“ Q3/Q1	400	400	400	400	400	400	400	400	400
Q4 [m³/h]	50	78.75	125	200	312.5	500	787.5	1250	2000
<b>Q3 [m³/h]</b>	<b>40</b>	<b>63</b>	<b>100</b>	<b>160</b>	<b>250</b>	<b>400</b>	<b>630</b>	<b>1000</b>	<b>1600</b>
Q2 [m³/h]	0.16	0.25	0.4	0.64	1.0	1.6	2.52	4.0	6.4
Q1 [m³/h]	0.1	0.16	0.25	0.4	0.63	1.0	1.58	2.5	4.0

Order code: P24	DN 350 (14")	DN 400 (16")	DN 450 (18")	DN 500 (20")	DN 600 (24")
„R“ Q3/Q1	40	40	40	40	40
Q4 [m³/h]	1250	1250	2000	2000	3125
<b>Q3 [m³/h]</b>	<b>1000</b>	<b>1000</b>	<b>1600</b>	<b>1600</b>	<b>2500</b>
Q2 [m³/h]	40.0	40.0	64.0	64.0	100.0
Q1 [m³/h]	25.0	25.0	40.0	40.0	62.5

Order code: P25	DN 350 (14")	DN 400 (16")	DN 450 (18")	DN 500 (20")	DN 600 (24")
„R“ Q3/Q1	63	63	63	63	63
Q4 [m <sup>3</sup> /h]	1250	2000	3125	3125	5000
<b>Q3 [m<sup>3</sup>/h]</b>	<b>1000</b>	<b>1600</b>	<b>2500</b>	<b>2500</b>	<b>4000</b>
Q2 [m <sup>3</sup> /h]	25.4	40.63	63.49	63.49	101.6
Q1 [m <sup>3</sup> /h]	15.9	25.4	39.7	39.7	63.49

Order code: P26	DN 350 (14")	DN 400 (16")	DN 450 (18")	DN 500 (20")	DN 600 (24")
„R“ Q3/Q1	80	80	80	80	80
Q4 [m <sup>3</sup> /h]	2000	3125	5000	5000	7875
<b>Q3 [m<sup>3</sup>/h]</b>	<b>1600</b>	<b>2500</b>	<b>4000</b>	<b>4000</b>	<b>6300</b>
Q2 [m <sup>3</sup> /h]	32.0	50.0	80.0	80.0	126.0
Q1 [m <sup>3</sup> /h]	20.0	31.25	50.0	50.0	78.75

Order code: P27	DN 350 (14")	DN 400 (16")	DN 450 (18")	DN 500 (20")	DN 600 (24")
„R“ Q3/Q1	100	100	100	100	100
Q4 [m <sup>3</sup> /h]	3125	3125	5000	5000	7875
<b>Q3 [m<sup>3</sup>/h]</b>	<b>2500</b>	<b>2500</b>	<b>4000</b>	<b>4000</b>	<b>6300</b>
Q2 [m <sup>3</sup> /h]	40.0	40.0	64.0	64.0	100.8
Q1 [m <sup>3</sup> /h]	25.0	25.0	40.0	40.0	63.0

Order code: P29	DN 700 (28")	DN 750 (30")	DN 800 (32")	DN 900 (36")	DN 1000 (40")	DN 1200 (48")
„R“ Q3/Q1	40	40	40	40	40	40
Q4 [m <sup>3</sup> /h]	5000	5000	5000	7875	7875	7875
<b>Q3 [m<sup>3</sup>/h]</b>	<b>4000</b>	<b>4000</b>	<b>4000</b>	<b>6300</b>	<b>6300</b>	<b>6300</b>
Q2 [m <sup>3</sup> /h]	160.0	160.0	160.0	252.0	252.0	252.0
Q1 [m <sup>3</sup> /h]	100.0	100.0	100.0	157.5	157.5	157.5

Order code: P30	DN 700 (28")	DN 750 (30")	DN 800 (32")	DN 900 (36")	DN 1000 (40")	DN 1200 (48")
„R“ Q3/Q1	63	63	63	63	63	-
Q4 [m <sup>3</sup> /h]	5000	5000	5000	7875	7875	-
<b>Q3 [m<sup>3</sup>/h]</b>	<b>4000</b>	<b>4000</b>	<b>4000</b>	<b>6300</b>	<b>6300</b>	-
Q2 [m <sup>3</sup> /h]	101.6	101.6	101.6	160.0	160.0	-
Q1 [m <sup>3</sup> /h]	63.5	63.5	63.5	100.0	100.0	-

Order code: P31	DN 700 (28")	DN 750 (30")	DN 800 (32")	DN 900 (36")	DN 1000 (40")	DN 1200 (48")
„R“ Q3/Q1	80	80	80	80	80	-
Q4 [m <sup>3</sup> /h]	5000	5000	5000	7875	7875	-
<b>Q3 [m<sup>3</sup>/h]</b>	<b>4000</b>	<b>4000</b>	<b>4000</b>	<b>6300</b>	<b>6300</b>	-
Q2 [m <sup>3</sup> /h]	80.0	80.0	80.0	126.0	126.0	-
Q1 [m <sup>3</sup> /h]	50.0	50.0	50.0	78.75	78.75	-

The label is placed on the transmitter housing. An example of the product label is shown below:

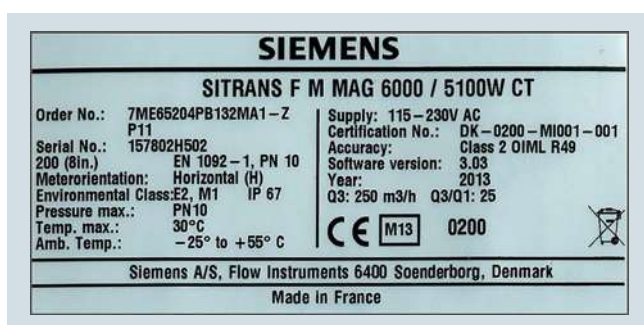

OIML R 49/MI-001 approvals valid for:

- DN 50 to DN 1200 (2" to 48")
- Horizontal and vertical installation
- Compact or remote with max. 500 m cable
- Power supply 115 to 230 V AC, 12 to 24 V AC/DC
- With or without communication module

Other restrictions may apply (see certificate).

Special OIML / MI-001 settings:

- Unit: m<sup>3</sup>
- Qmax: Q3
- Low flow cut-off: 0.1 %
- Digital output: Frequency

For other factory settings, see Operating Instructions.



## Flow Measurement

### SITRANS F M

#### Flow sensor MAG 5100 W

























##### Selection and Ordering data

Sensor SITRANS F M MAG 5100 W  Article No. Order Code







Hastelloy electrodes, carbon steel flanges, EU water markets and low flow applications

 Click on the Article No. for the online configuration in the PIA Life Cycle Portal.



##### Diameter

DN 15 (½")	 1 V
DN 25 (1")	 2 D
DN 40 (1½")	 2 R
DN 50 (2")	 2 Y
DN 65 (2½")	 3 F
DN 80 (3")	 3 M
DN 100 (4")	 3 T
DN 125 (5")	 4 B
DN 150 (6")	 4 H
DN 200 (8")	 4 P
DN 250 (10")	 4 V
DN 300 (12")	 5 D
DN 350 (14")	 5 K
DN 400 (16")	 5 R
DN 450 (18")	 5 Y
DN 500 (20")	 6 F
DN 600 (24")	 6 P
DN 700 (28")	 6 Y
DN 750 (30")	 7 D
DN 800 (32")	 7 H
DN 900 (36")	 7 M
DN 1000 (40")	 7 R
(42")	 7 U
(44")	 7 V
DN 1200 (48")	 8 B

##### Flange norm and pressure rating

<u>to EN 1092-1</u>	
PN 10 (DN 200 ... 1200/8" ... 48")	 B
PN 16 (DN 50 ... 1200/2" ... 48")	 C
PN 16, non PED (DN 700 ... 1200/28" ... 48")	 D
PN 40 (DN 15 ... 40/½" ... 1½")	 F
<u>to ANSI B16.5</u>	
class 150 (½" ... 24")	 J
<u>to AWWA C-207</u>	
Class D (28" ... 48")	 L
<u>to AS 4087</u>	
PN 16 (DN 50 ... 1200/2" ... 48")	 N

##### Flange material and coating

Carbon steel flanges ASTM A 105, corrosion-resistant coating of category C4-medium	 1
Carbon steel flanges ASTM A 105, 300 µm corrosion-resistant coating of category C4-medium	 4

##### Liner material







EPDM	 2
NBR Hard Rubber	 3

##### Selection and Ordering data

















Sensor SITRANS F M MAG 5100 W Article No. Order Code

Hastelloy electrodes, carbon steel flanges, EU water markets and low flow applications







##### Transmitter

Sensor for remote transmitter (Order transmitter separately)	 A
MAG 6000 I, Aluminum, 18 ... 90 V DC, 115 ... 230 V AC	 C
MAG 6000, Polyamid, 11 ... 30 V DC/11 ... 24 V AC	 H
MAG 6000, Polyamid, 115 ... 230 V AC	 J
MAG 5000, Polyamid, 11 ... 30 V DC/11 ... 24 V AC	 K
MAG 5000, Polyamid, 115 ... 230 V AC	 L
MAG 6000 CT, Polyamid, 115 ... 230 V AC	 M



##### Transmitter including wall-mounting kit for remote design

MAG 5000, Polyamid, 115 ... 230 V AC, incl. special wall-mounting unit (approved marine equipment)		
• M20x1.5 cable glands	 Z	 P O C
• ½" NPT cable glands	 Z	 P O D
MAG 6000, Polyamid, 115 ... 230 V AC, incl. special wall-mounting unit (approved marine equipment)		
• M20x1.5 cable glands	 Z	 P O G
• ½" NPT cable glands	 Z	 P O H
MAG 6000 CT, Polyamid, 11 ... 30 V DC/11 ... 24 V AC, incl. wall-mounting unit		
• M20x1.5 cable glands	 Z	 P O J
• ½" NPT cable glands	 Z	 P O K
MAG 6000 CT, Polyamid, 115 ... 230 V AC, incl. wall-mounting unit		
• M20x1.5 cable glands	 Z	 P O L
• ½" NPT cable glands	 Z	 P O M

##### Communication

None	 A
HART	 B
PROFIBUS PA Profile 3 (only MAG 6000/ MAG 6000 I)	 F
PROFIBUS DP Profile 3 (only MAG 6000/ MAG 6000 I)	 G
Modbus RTU/RS 485 (only MAG 6000/ MAG 6000 I)	 E
FOUNDATION Fieldbus H1 (only MAG 6000/ MAG 6000 I)	 J

##### Cable glands/terminal box

Metric: Polyamide terminal box or MAG 6000 I compact	 1
½" NPT: Polyamide terminal box or MAG 6000 I compact	 2

 We can offer shorter delivery times for configurations designated with the Quick Ship Symbol . For details see page 10/11 in the appendix.





## Flow Measurement

### SITRANS F M

#### Flow sensor MAG 5100 W

Selection and Ordering data	Article No.
<b>Sensor SITRANS F M MAG 5100 W</b>	➔ 7 ME 6 5 8 0 -
Hastelloy electrodes, carbon steel flanges, Non EU water markets	
➔ Click on the Article No. for the online configuration in the PIA Life Cycle Portal.	
<b>Diameter</b>	
DN 25 (1")	◆ 2 D
DN 40 (1½")	◆ 2 R
DN 50 (2")	◆ 2 Y
DN 65 (2½")	◆ 3 F
DN 80 (3")	◆ 3 M
DN 100 (4")	◆ 3 T
DN 125 (5")	◆ 4 B
DN 150 (6")	◆ 4 H
DN 200 (8")	◆ 4 P
DN 250 (10")	◆ 4 V
DN 300 (12")	◆ 5 D
DN 350 (14")	◆ 5 K
DN 400 (16")	◆ 5 R
DN 450 (18")	◆ 5 Y
DN 500 (20")	◆ 6 F
DN 600 (24")	◆ 6 P
DN 700 (28")	◆ 6 Y
DN 750 (30")	◆ 7 D
DN 800 (32")	◆ 7 H
DN 900 (36")	◆ 7 M
DN 1000 (40")	◆ 7 R
(42")	◆ 7 U
(44")	◆ 7 V
DN 1200 (48")	◆ 8 B
DN 1400 (54")	◆ 8 F
DN 1500 (60")	◆ 8 K
DN 1600 (66")	◆ 8 P
DN 1800 (72")	◆ 8 T
DN 2000 (78")	◆ 8 Y
<b>Flange norm and pressure rating</b>	
to <u>EN 1092-1</u>	
PN 6 (DN 1400 ... 2000 (54" ... 78")) <sup>1)</sup>	◆ A
PN 10 (DN 200 ... 2000 (8" ... 78")) <sup>1)</sup>	◆ B
PN 16 (DN 65 ... 600 (2½" ... 24"))	◆ C
PN 16, non-PED (DN 700 ... 2000 (28" ... 78"))	◆ D
PN 40 (DN 25 ... 50 (1" ... 2"))	◆ F
to <u>ANSI B16.5</u>	
class 150 (1" ... 24")	◆ J
to <u>AWWA C-207</u>	
Class D (28" ... 78") <sup>1)</sup>	◆ L
to <u>AS 4087</u>	
PN 16 (DN 50 ... 1200 (2" ... 48"))	◆ N
to <u>JIS</u>	
B 2220:2004 K10 (1" ... 24")	◆ R
<b>Flange material and coating</b>	
Carbon steel flanges ASTM A 105, corrosion-resistant coating of category C4-medium	◆ 1
Carbon steel flanges ASTM A 105, 300 µm corrosion-resistant coating of category C4-medium	◆ 4
<b>Liner material</b>	
Ebonite Hard Rubber	◆ 4
<b>Electrode material</b>	
Hastelloy	◆ 2

Selection and Ordering data	Article No.
<b>Sensor SITRANS F M MAG 5100 W</b>	7 ME 6 5 8 0 -
Hastelloy electrodes, carbon steel flanges, Non EU water markets	
<b>Transmitter with display</b>	
Sensor for remote transmitter (Order transmitter separately)	◆ A
MAG 6000, Polyamid, 11 ... 30 V DC/11 ... 24V AC	◆ H
MAG 6000, Polyamid, 115 ... 230 V AC	◆ J
MAG 5000, Polyamid, 11 ... 30 V DC/11 ... 24V AC	◆ K
MAG 5000, Polyamid, 115 ... 230 V AC	◆ L
<b>Communication</b>	
No communication, add-on possible	◆ A
HART	◆ B
PROFIBUS PA Profile 3 (only MAG 6000)	◆ F
PROFIBUS DP Profile 3 (only MAG 6000)	◆ G
Modbus RTU/RS 485 (only MAG 6000)	◆ E
FOUNDATION Fieldbus H1 (only MAG 6000)	◆ J
<b>Cable glands/terminal box</b>	
Metric: Polyamide terminal box or MAG 6000 I compact	◆ 1
½" NPT: Polyamide terminal box or MAG 6000 I compact	◆ 2

<sup>1)</sup> DN 1400 to DN 2000 (54" to 78") do not conform to PED or CRN.

◆ We can offer shorter delivery times for configurations designated with the Quick Ship Symbol ◆. For details see page 10/11 in the appendix.

Selection and Ordering data	Order code
<b>Additional information</b>	
Please add “-Z” to Article No. and specify Order code(s) and plain text.	
Certificates	
Pressure test certificate according to EN 10204-3.1	<b>C01</b>
Factory certificate according to EN 10204-2.2	<b>C14</b>
Factory certificate according to EN 10204-2.1	<b>C15</b>
Special calibration	
• 5-point calibration for DN 15 ... DN 200 <sup>1)</sup>	<b>D01</b>
• 5-point calibration for DN 250 ... DN 600 <sup>1)</sup>	<b>D02</b>
• 5-point calibration for DN 700 ... DN 1200 <sup>1)</sup>	<b>D03</b>
• 10-point calibration for DN 15 ... DN 200 <sup>2)</sup>	<b>D06</b>
• 10-point calibration for DN 250 ... DN 600 <sup>2)</sup>	<b>D07</b>
• 10-point calibration for DN 700 ... DN 1200 <sup>2)</sup>	<b>D08</b>
• Default (2 x 25 % and 2 x 90 %) match-pair calibration for DN 15 ... DN 200	<b>D11</b>
• Default (2 x 25 % and 2 x 90 %) match-pair calibration for DN 250 ... DN 600	<b>D12</b>
• Default (2 x 25 % and 2 x 90 %) match-pair calibration for DN 700 ... DN 1200	<b>D13</b>
• 5-point, matched-pair calibration for DN 15 ... DN 200 <sup>2)</sup>	<b>D15</b>
• 5-point, matched-pair calibration for DN 250 ... DN 600 <sup>2)</sup>	<b>D16</b>
• 5-point, matched-pair calibration for DN 700 ... DN 1200 <sup>2)</sup>	<b>D17</b>
• 10-point, matched-pair calibration for DN 15 ... DN 200 <sup>3)</sup>	<b>D18</b>
• 10-point, matched-pair calibration for DN 250 ... DN 600 <sup>3)</sup>	<b>D19</b>
• 10-point, matched-pair calibration for DN 700 ... DN 1200 <sup>3)</sup>	<b>D20</b>
Terminal blocks	
• Factory mounted terminal blocks	<b>N02</b>
Region/customer specific labels	
• Chinese label	<b>W06</b>
• CRN label (Canada)	<b>W27</b>
Tag name plate, stainless (specify in plain text)	<b>Y17</b>
Tag name plate, plastic (self-adhesive)	<b>Y18</b>
Customer-specific transmitter setup	<b>Y20</b>
Sensor cables wired (specify Article No. for sensor cables)	<b>Y40</b>
Sensor cables wired and IP68 sealing (specify Article No. for sensor cables)	<b>Y41</b>
Special version (specify in plain text)	<b>Y99</b>

<sup>1)</sup> 20 %, 40 %, 60 %, 80 %, 100 % of factory  $Q_{max}$

<sup>2)</sup> Ascending and descending at 20 %, 40 %, 60 %, 80 %, 100 % of factory  $Q_{max}$

• We can offer shorter delivery times for configurations designated with the Quick Ship Symbol . For details see page 10/11 in the appendix.

### Operating instructions for SITRANS F M MAG 5100 W

Description	Article No.
• German	<b>A5E03376527</b>
• English	<b>A5E03063678</b>

All literature is available to download for free, in a range of languages, at [www.siemens.com/processinstrumentation/documentation](http://www.siemens.com/processinstrumentation/documentation)

### Accessories

Description	Article No.
Potting kit for IP68/ NEMA 6P sealing of sensor junction box	◆ <b>FDK:085U0220</b>



◆ We can offer shorter delivery times for configurations designated with the Quick Ship Symbol . For details see page 10/11 in the appendix.

MAG 5000/6000 transmitters and sensors are packed in separate boxes, the final assembly takes place during installation at the customer's site.

Communication module will be pre-mounted in the transmitter.

Please use online Product selector to get latest updates.

Product selector link: [www.pia-portal.automation.siemens.com](http://www.pia-portal.automation.siemens.com)

## Flow Measurement

### SITRANS F M

#### Flow sensor MAG 5100 W

#### Dimensional drawings

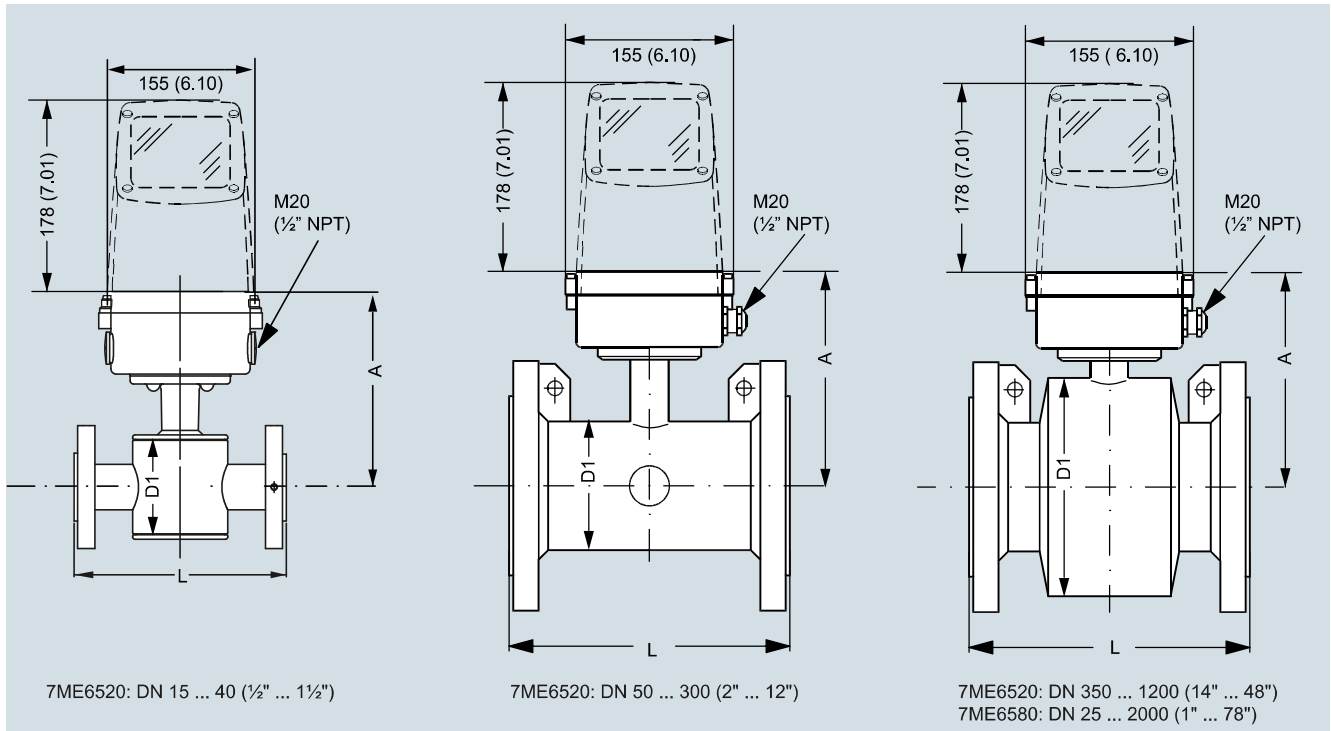

7ME6520 NBR or EPDM liner						7ME6580 Ebonite liner					
Nominal size A		A		D1		A		D1		L <sup>1)</sup>	
[mm]	[inch]	[mm]	[inch]	[mm]	[inch]	[mm]	[inch]	[mm]	[inch]	[mm]	[inch]
15	1/2	177	7.0	77	3.0	-	-	-	-	200	7.9
25	1	187	7.4	96	3.8	187	7.4	104	4.09	200	7.9
40	1 1/2	202	8.0	127	5.0	197	7.8	124	4.88	200	7.9
50	2	188	7.4	76	3.0	205	8.1	139	5.47	200	7.9
65	2 1/2	194	7.6	89	3.5	212	8.3	154	6.06	200	7.9
80	3	200	7.9	102	4.0	222	8.7	174	6.85	200	7.9
100	4	207	8.1	114	4.5	242	9.5	214	8.43	250	9.8
125	5	217	8.5	140	5.5	255	10.0	239	9.41	250	9.8
150	6	232	9.1	168	6.6	276	10.9	282	11.1	300	11.8
200	8	257	10.1	219	8.6	304	12.0	338	13.31	350	13.8
250	10	284	11.2	273	10.8	332	13.1	393	15.47	450	17.7
300	12	310	12.2	324	12.8	357	14.1	444	17.48	500	19.7
350	14	382	15.0	451	17.8	362	14.3	451	17.76	550	21.7
400	16	407	16.0	502	19.8	387	15.2	502	19.76	600	23.6
450	18	438	17.2	563	22.2	418	16.5	563	22.16	600	23.6
500	20	463	18.2	614	24.2	443	17.4	614	24.17	600	23.6
600	24	514	20.2	715	28.2	494	19.4	715	28.15	600	23.6
700	28	564	22.2	816	32.1	544	21.4	816	32.13	700	27.6
750	30	591	23.3	869	34.2	571	22.5	869	34.21	750	29.5
800	32	616	24.3	927	36.5	606	23.9	927	36.5	800	31.5
900	36	663	26.1	1032	40.6	653	25.7	1032	40.63	900	35.4
1000	40	714	28.1	1136	44.7	704	27.7	1136	44.72	1000	39.4
	42	714	28.1	1136	44.7	704	27.7	1136	44.72	1000	39.4
	44	765	30.1	1238	48.7	755	29.7	1238	48.74	1100	43.3
1200	48	820	32.3	1348	53.1	810	31.9	1348	53.07	1200	47.2
1400	54	-	-	-	-	925	36.4	1574	65.94	1400	55.1
1500	60	-	-	-	-	972	38.2	1672	65.83	1500	59.1
1600	66	-	-	-	-	1025	40.4	1774	75.39	1600	63
1800	72	-	-	-	-	1123	44.2	1974	77.72	1800	70.9
2000	78	-	-	-	-	1223	48.1	2174	85.59	2000	78.7

<sup>1)</sup> Tolerances on built-in length:

DN 15 to DN 200 (1/2" to 8"): +0/-3 mm (+0/-0.12"). DN 250 to DN 400 (10" to 16"): +0/-5 mm (+0/-0.20").

DN 450 to DN 600 (18" to 24"): +5/-5 mm (+0.20/-0.20"). DN 700 to DN 2000 (28" to 78"): +10/-10 mm (+0.39/-0.39")

- not available

## MAG 5100 W/6000 I Compact

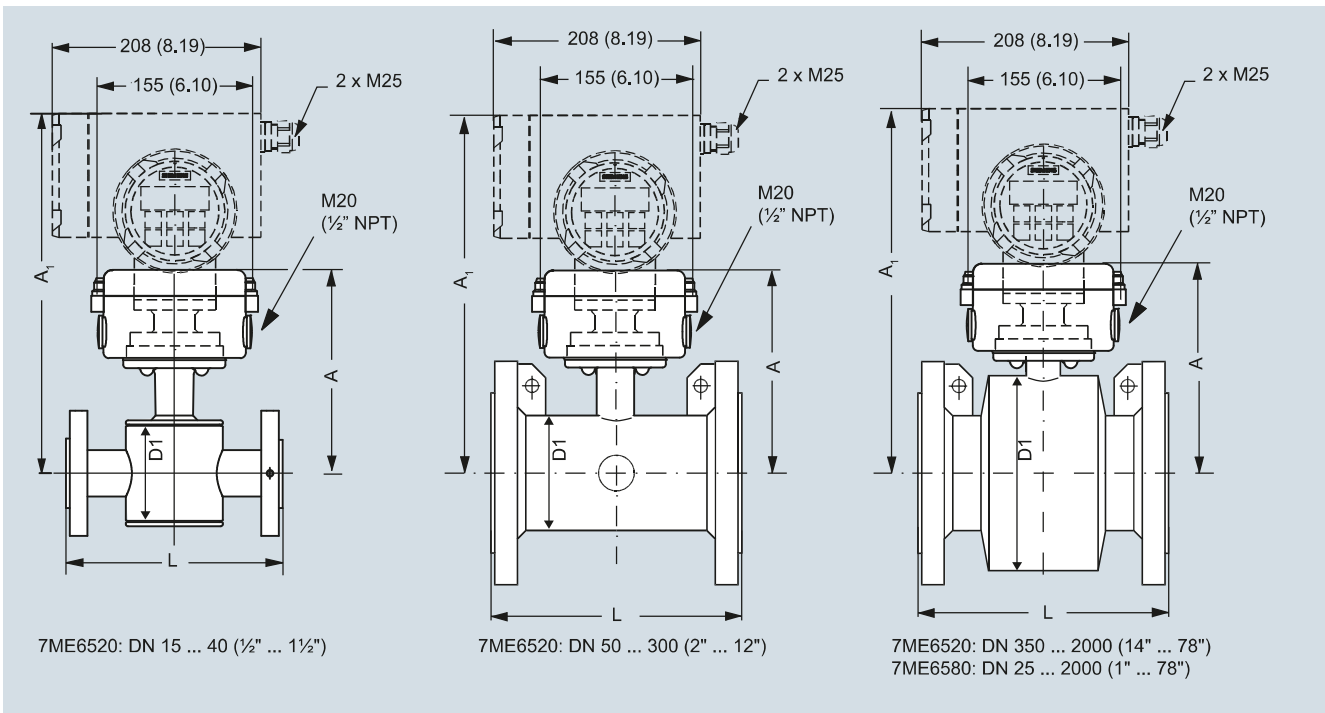

Nominal size	7ME6520 NBR or EPDM liner							7ME6580 Ebonite liner							L <sup>1)</sup>	
	A	A1	D1		A	A1	D1									
[mm] [inch]	[mm] [inch]	[mm] [inch]	[mm] [inch]	[mm] [inch]	[mm] [inch]	[mm] [inch]	[mm] [inch]	[mm] [inch]	[mm] [inch]	[mm] [inch]	[mm] [inch]	[mm] [inch]	[mm] [inch]	[mm] [inch]		
15	1/2	177	7.0	331	13.0	77	3.0	187	7.4	-	-	-	-	200	7.9	
25	1	187	7.4	341	13.4	96	3.8	187	7.4	341	13.4	104	4.09	200	7.9	
40	1 1/2	202	8.0	356	14.0	127	5.0	197	7.8	351	13.8	124	4.88	200	7.9	
50	2	188	7.4	342	13.5	76	3.0	205	8.1	359	14.1	139	5.47	200	7.9	
65	2 1/2	194	7.6	348	13.7	89	3.5	212	8.3	366	14.4	154	6.06	200	7.9	
80	3	200	7.9	354	14.0	102	4.0	222	8.7	376	14.8	174	6.85	200	7.9	
100	4	207	8.1	361	14.2	114	4.5	242	9.5	396	15.6	214	8.43	250	9.8	
125	5	217	8.5	371	14.6	140	5.5	255	10.0	409	16.1	239	9.41	250	9.8	
150	6	232	9.1	386	15.2	168	6.6	276	10.9	430	16.9	282	11.1	300	11.8	
200	8	257	10.1	411	16.2	219	8.6	304	12.0	458	18.0	338	13.31	350	13.8	
250	10	284	11.2	438	17.2	273	10.8	332	13.1	486	19.1	393	15.47	450	17.7	
300	12	310	12.2	464	18.3	324	12.8	357	14.1	511	20.1	444	17.48	500	19.7	
350	14	382	15.0	536	21.1	451	17.8	362	14.3	516	20.3	451	17.76	550	21.7	
400	16	407	16.0	561	22.1	502	19.8	387	15.2	541	21.3	502	19.76	600	23.6	
450	18	438	17.2	592	23.3	563	22.2	418	16.5	572	22.5	563	22.16	600	23.6	
500	20	463	18.2	617	24.3	614	24.2	443	17.4	597	23.5	614	24.17	600	23.6	
600	24	514	20.2	668	26.3	715	28.2	494	19.4	648	25.5	715	28.15	600	23.6	
700	28	564	22.2	718	28.3	816	32.1	544	21.4	698	27.5	816	32.13	700	27.6	
750	30	591	23.3	745	29.3	869	34.2	571	22.5	725	28.5	869	34.21	750	29.5	
800	32	616	24.3	770	30.3	927	36.5	606	23.9	760	29.9	927	36.5	800	31.5	
900	36	663	26.1	817	32.2	1032	40.6	653	25.7	807	31.8	1032	40.63	900	35.4	
1000	40	714	28.1	868	34.2	1136	44.7	704	27.7	858	33.8	1136	44.72	1000	39.4	
	42	714	28.1	868	34.2	1136	44.7	704	27.7	858	33.8	1136	44.72	1000	39.4	
	44	765	30.1	919	36.2	1238	48.7	755	29.7	904	35.6	1238	48.74	1100	43.3	
1200	48	820	32.3	974	38.3	1348	53.1	810	31.9	964	38.0	1348	53.07	1200	47.2	
1400	54	-	-	-	-	-	-	925	36.4	1079	42.5	1574	61.97	1400	55.1	
1500	60	-	-	-	-	-	-	972	38.2	1126	44.3	1672	65.83	1500	59.1	
1600	66	-	-	-	-	-	-	1025	40.4	1179	46.4	1774	69.84	1600	63.0	
1800	72	-	-	-	-	-	-	1123	44.2	1277	50.3	1974	77.72	1800	70.9	
2000	78	-	-	-	-	-	-	1223	48.1	1377	54.2	2174	85.59	2000	78.7	

1) Tolerances on built-in length:

DN 15 to DN 200 (1/2" to 8"): +0/-3 mm (+0/-0.12"), DN 250 to DN 400 (10" to 16"): +0/-5 mm (+0/-0.20"),

DN 450 to DN 600 (18" to 24"): +5/-5 mm (+0.20/-0.20"), DN 700 to DN 2000 (28" to 78"): +10/-10 mm (+0.39/-0.39")

- not available

## Flow Measurement

### SITRANS F M

#### Flow sensor MAG 5100 W

##### Weight

Nominal size		7ME6520 NBR or EPDM liner										7ME6580 Ebonite liner	
		PN 10		PN 16		PN 40		Class 150/AWWA		AS		PN 16	
[mm]	[inch]	[kg]	[lb]	[kg]	[lb]	[kg]	[lb]	[kg]	[lb]	[kg]	[lb]	[kg]	[lb]
15	½	-	-	-	-	4	9	4	9	4	9	5	11
25	1	-	-	-	-	6	12	5	11	4	9	5	11
40	1½	-	-	-	-	8	18	7	15	7	15	8	17
50	2	-	-	9	20	-	-	8	20	9	20	9	20
65	2½	-	-	10.7	24	-	-	11	24	10.7	24	11	24
80	3	-	-	11.6	26	-	-	13	28	11.6	26	12	26
100	4	-	-	15.2	33	-	-	19	41	15.2	33	16	35
125	5	-	-	20.4	45	-	-	24	52	-	-	19	42
150	6	-	-	26	57	-	-	29	64	26	57	27	60
200	8	48	106	48	106	-	-	56	124	48	106	40	88
250	10	64	141	69	152	-	-	79	174	69	152	60	132
300	12	76	167	86	189	-	-	110	243	86	189	80	176
350	14	104	229	125	274	-	-	139	307	115	254	110	242
400	16	119	263	143	314	-	-	159	351	125	277	125	275
450	18	136	299	173	381	-	-	182	400	141	311	175	385
500	20	163	359	223	491	-	-	225	495	189	418	200	440
600	24	236	519	338	744	-	-	320	704	301	664	287	633
700	28	270	595	314	692	-	-	273	602	320	704	330	728
750	30	-	-	-	-	-	-	329	725	-	-	360	794
800	32	346	763	396	873	-	-	365	804	428	944	450	992
900	36	432	951	474	1043	-	-	495	1089	619	1362	530	1168
1000	40	513	1130	600	1321	-	-	583	1282	636	1399	660	1455
	42	-	-	-	-	-	-	687	1512	-	-	-	-
	44	-	-	-	-	-	-	763	1680	-	-	1140	2513
1200	48	643	1415	885	1948	-	-	861	1896	813	1789	1180	2601
1400	54	1592	3510	-	-	-	-	-	-	-	-	1600	3528
1500	60	-	-	-	-	-	-	-	-	-	-	2460	5423
1600	66	2110	4652	-	-	-	-	-	-	-	-	2525	5566
1800	72	2560	5644	-	-	-	-	-	-	-	-	2930	6460
2000	78	3640	8025	-	-	-	-	-	-	-	-	3665	8080

- not available

With transmitter MAG 5000 and MAG 6000 compact, weight is increased by approximately 0.8 kg (1.8 lb), with MAG 6000 I, weight is increased by 5.5 kg (12.1 lb).